

FOREWORD

This wiring diagram has been prepared to provide information on the electrical system of the 1991 TOYOTA MR2.

Applicable models: SW20, 21 Series

For service specifications and repair procedures of the above models other than those listed in this manual, refer to the following manuals;

Manual Name	Pub No.
● 1991 MR2 Repair Manual	RM179U
● 1991 MR2 New Car Features	NCF062U

All information in this manual is based on the latest product information at the time of publication. However, specifications and procedures are subject to change without notice.

TOYOTA MOTOR CORPORATION

NOTICE

Servicing vehicles with an SRS AIRBAG (referred to as the airbag in the remainder of this manual) installed.

When handling airbag components (removal, installation or inspection, etc.), always follow the directions given in the repair manuals listed above to prevent the occurrence of accidents and airbag malfunction.

1991 TOYOTA MR2 ELECTRICAL WIRING DIAGRAM

	Section No.	Page
INTRODUCTION	A	2
HOW TO USE THIS MANUAL	B	3
TROUBLESHOOTING	C	10
ABBREVIATIONS	D	13
GLOSSARY OF TERMS AND SYMBOLS	E	14
RELAY LOCATIONS	F	16
ELECTRICAL WIRING ROUTING	G	20
POWER SOURCE (Current Flow Chart)	H	34
SYSTEM CIRCUITS	I	43
GROUND POINTS	J	179
OVER ALL ELECTRICAL WIRING DIAGRAM	K	184

© 1996 TOYOTA MOTOR CORPORATION

All rights reserved. This book may not be reproduced or copied, in whole or in part, without the written permission of Toyota Motor Corporation.

A INTRODUCTION

This manual consists of the following 12 sections:

No.	Section	Description
1	INDEX	Index of the contents of this manual.
2	INTRODUCTION	Brief explanation of each section.
3	HOW TO USE THIS MANUAL	Instructions on how to use this manual.
4	TROUBLE-SHOOTING	Describes the basic inspection procedures for electrical circuits.
5	ABBREVIATIONS	Defines the abbreviations used in this manual.
6	GLOSSARY OF TERMS AND SYMBOLS	Defines the symbols and functions of major parts.
7	RELAY LOCATIONS	Shows position of the Electronic Control Unit, Relays, Relay Block, etc. This section is closely related to the system circuit.
8	ELECTRICAL WIRE ROUTING	Describes position of Parts Connectors, Splice points, Ground points, etc. This section is closely related to the system circuit.
9	POWER SOURCE (Current Flow Chart)	Describes power distribution from the power supply to various electrical loads.
10	INDEX	Index of the system circuits.
11	SYSTEM CIRCUITS	Electrical circuits of each system are shown from the power supply through ground points. Wiring connections and their positions are shown and classified by code according to the connection method. (Refer to the section, "How to use this manual"). The "System Outline" and "Service Hints" useful for troubleshooting are also contained in this section.
	GROUND POINTS	Shows ground positions of all parts described in this manual.
12	OVERALL WIRING DIAGRAM	Provides circuit diagrams showing the circuit connections.

This manual provides information on the electrical circuits installed on vehicles by dividing them into each system circuit.

The actual wiring of each system circuit is shown from the point where the power source is received from the battery as far as each ground point. (All circuit diagrams are shown with the switches in the OFF position.)

When troubleshooting any problem, first understand the operation of the circuit where the problem was detected (see System Circuit section), the power source supplying power to that circuit (see Power Source section), and the ground points (see Ground Points section). See the System Outline to understand the circuit operation.

When the circuit operation is understood, begin troubleshooting of the problem circuit to isolate the cause. Use Relay Location and Electrical Wire Routing sections to find each part, junction block and wiring harness connectors, wiring harness and wiring harness connectors, splice points, and ground points of each system circuit. Internal wiring for each junction block is also provided for better understanding of connection within a junction block.

Wiring related to each system is indicated in each system circuit by arrows (from____, to____). When overall connections are required, see the Overall Wiring Diagram at the end of this manual.

B HOW TO USE THIS MANUAL



POWER WINDOW

* The system shown here is an EXAMPLE ONLY. It is different to the actual circuit shown in the SYSTEM CIRCUITS SECTION.

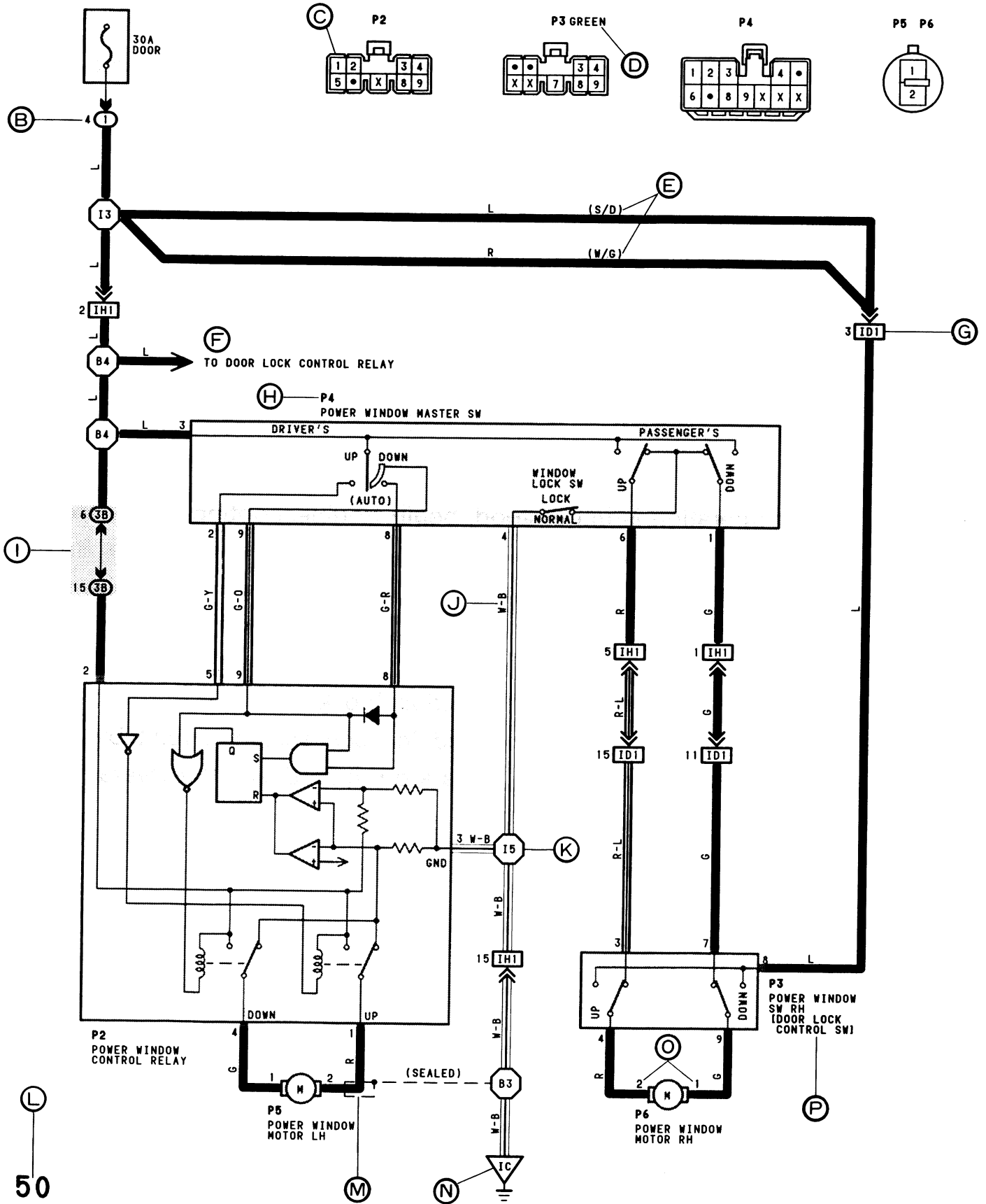

- (A):** System Title
- (B):** Indicates a Relay Block. No shading is used and only the Relay Block No. is shown to distinguish it from the J/B.

Example: **(1)** Indicates Relay Block No. 1.

- (C):** Indicates the connector to be connected to a part (the numeral indicates the pin No.)

Explanation of pin use.

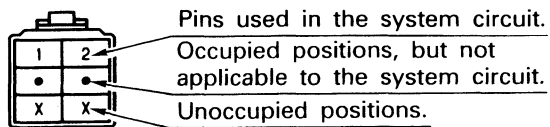

The pins shown are only for the highest grade, or only include those in the specification.

- (D):** Connector Color
Connectors not indicated are milky white in color.
- (E):** () is used to indicate different wiring and connector, etc. when the vehicle model, engine type, or specification is different.
- (F):** Indicates related system.
- (G):** Indicates the wiring harness and wiring harness connector. The wiring harness with male terminal is shown with arrows (↘). Outside numerals are pin numbers.

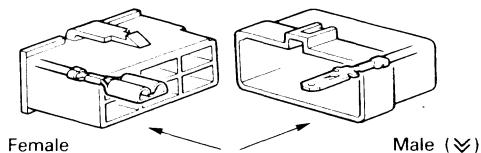

The first letter of the code for each wiring harness and wiring harness connector(s) indicates the component's location, e.g., "E" for the Engine Compartment, "I" for the Instrument Panel and Surrounding area, and "B" for the Body and Surrounding area.

When more than one code has the first and second letters in common, followed by numbers (e.g., IH1, IH2), this indicates the same type of wiring harness and wiring harness connector.

- (H):** Represents a part (all parts are shown in sky blue). The code is the same as the code used in parts position.

- (I):** Junction Block (The number in the circle is the J/B No. and the connector code is shown beside it). Junction Blocks are shaded to clearly separate them from other parts (different junction blocks are shaded differently for further clarification).

Example:

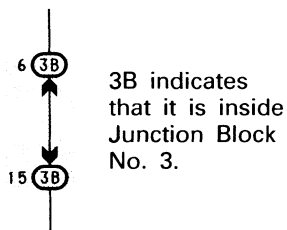

- (J):** Indicates the wiring color.
Wire colors are indicated by an alphabetical code.

B = Black	L = Blue	R = Red
BR = Brown	LG = Light Green	V = Violet
G = Green	O = Orange	W = White
GR = Gray	P = Pink	Y = Yellow

The first letter indicates the basic wire color and the second letter indicates the color of the stripe.

Example: L - Y

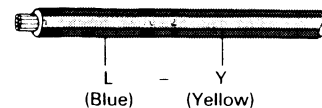

- (K):** Indicates a wiring Splice Point (Codes are "E" for the Engine Room, "I" for the Instrument Panel, and "B" for the Body).

Example:

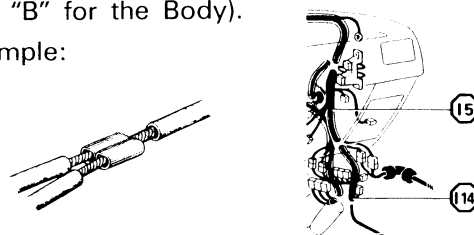

The Location of Splice Point I 5 is indicated by the shaded section.

- (L):** Page No.
- (M):** Indicates a sealed wiring harness.



- (N):** Indicates a ground point.
The first letter of the code for each ground point(s) indicates the component's location, e.g., "E" for the Engine Compartment, "I" for the Instrument Panel and Surrounding area, and "B" for the Body and Surrounding area.

- (O):** Indicates the pin number of the connector.
The numbering system is different for female and male connectors.

Example: Numbered in order from upper left to lower right Numbered in order from upper right to lower left

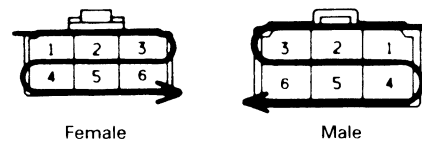

- (P):** When 2 parts both use one connector in common, the parts connector name used in the wire routing section is shown in square brackets [].

B HOW TO USE THIS MANUAL

Q

SYSTEM OUTLINE

WITH THE IGNITION SW TURNED ON, THE CURRENT FLOWS TO TERMINAL 3 OF THE POWER WINDOW MASTER SW, TERMINAL 2 OF THE POWER WINDOW CONTROL RELAY AND TERMINAL 8 OF THE POWER WINDOW SW THROUGH THE DOOR FUSE.

1. DRIVER'S WINDOW "MANUAL UP" OPERATION BY MASTER SW

HOLDING MANUAL SW(DRIVER'S) ON "UP" POSITION LOCATED IN POWER WINDOW MASTER SW, THE CURRENT FLOWS TO TERMINAL 5 OF THE POWER WINDOW CONTROL RELAY THROUGH TERMINAL 3 OF THE MASTER SW → TERMINAL 2 TO OPERATE A POWER WINDOW CONTROL RELAY. THUS THE CURRENT INSIDE THE RELAY FLOWS FROM TERMINAL 2 OF THE RELAY → TERMINAL 1 → TERMINAL 2 OF THE POWER WINDOW MOTOR → TERMINAL 1 → TERMINAL 4 OF THE RELAY → TERMINAL 3 → TO GROUND. THE MOTOR TURNS TO ASCENT THE WINDOW. RELEASING THIS SW, THE ROTATION OF MOTOR IS STOPPED AND THE WINDOWS CAN STOP AT WILL POINT.

(FOR THE "MANUAL DOWN" OPERATION, CURRENT FLOWS IN THE REVERSE DIRECTION BECAUSE THE TERMINALS WHERE IT FLOWS ARE CHANGED).

2. DRIVER'S WINDOW "AUTO DOWN" OPERATION BY MASTER SW

ONCE THE "AUTO DOWN" BUTTON OF THE MASTER SW IS PUSHED, THE CURRENT FLOWS TERMINAL 9 OF THE POWER WINDOW CONTROL RELAY THROUGH TERMINAL 3 OF THE MASTER SW → TERMINALS 8 AND 9 TO OPERATE THE RELAY. THUS THE CURRENT INSIDE THE POWER WINDOW CONTROL RELAY FLOWS FROM TERMINAL 2 OF THE RELAY → TERMINAL 4 → TERMINAL 1 OF THE POWER WINDOW MOTOR → TERMINAL 2 → TERMINAL 1 OF THE RELAY → TERMINAL 3 → TO GROUND. THE MOTOR CONTINUES THE ROTATION ENABLING TO DESCENT THE WINDOW.

THE WINDOW DESCENDS TO THE END POSITION, THE CURRENT WILL BE CUT OFF TO RELEASE THE AUTO DOWN FUNCTION BASED ON THE INCREASING CURRENT BETWEEN TERMINAL 2 OF THE RELAY AND TERMINAL 1 IN RELAY.

3. DRIVER'S WINDOW AUTO DOWN RELEASE OPERATION BY MASTER SW

HOLDING THE MANUAL SW(DRIVER'S) ON "UP" POSITION IN OPERATING AUTO DOWN, THE CURRENT FROM TERMINAL 3 OF THE MASTER SW PASSING TERMINAL 2 FLOWS TERMINAL 5 OF THE RELAY AND RELEASES THE AUTO DOWN FUNCTION IN THE POWER WINDOW CONTROL RELAY. RELEASING THE HAND FROM SW, WINDOW STOPS AND CONTINUING ON TOUCHING SW, THE FUNCTION SWITCHES TO MANUAL UP OPERATION.

4. PASSENGER'S WINDOW UP OPERATION(MASTER SW) AND WINDOW LOCK SW OPERATION

HOLDING PASSENGER'S WINDOW SW(MASTER SW) ON "UP", THE CURRENT FLOWS FROM TERMINAL 3 OF THE MASTER SW PASSING TERMINAL 6 TO TERMINAL 3 OF THE POWER WINDOW SW(PASSENGER'S) → TERMINAL 4 → TERMINAL 2 OF THE MOTOR → TERMINAL 1 → TERMINAL 9 OF THE POWER WINDOW SW → TERMINAL 7 → TERMINAL 1 OF THE MASTER SW → TERMINAL 4 TO GROUND. THE MOTOR RUNS TO ASCENT THE WINDOW. RELEASING THIS SW, THE ROTATION OF MOTOR IS STOPPED AND WINDOW CAN STOP AT WILL PLACE. SWITCHING THE WINDOW LOCK SW IN "LOCK" POSITION, THE CIRCUIT IS OPENED AND STOPPED THE MOTOR ROTATION.

(FOR THE DOWN OPERATION, CURRENT FLOWS IN THE REVERSE DIRECTION BECAUSE THE TERMINALS WHERE IT FLOWS ARE CHANGED).

R

SERVICE HINTS

P2 POWER WINDOW CONTROL RELAY

3-GROUND: ALWAYS CONTINUITY

2-GROUND: APPROX. 12VOLTS WITH IGNITION SW AT ON POSITION

5-GROUND: APPROX. 12VOLTS WITH IGNITION SW AT ON POSITION AND MASTER SW AT UP POSITION

8-GROUND: APPROX. 12VOLTS WITH IGNITION SW AT ON POSITION AND MASTER SW AT AUTO DOWN POSITION

9-GROUND: APPROX. 12VOLTS WITH IGNITION SW AT ON POSITION AND MASTER SW AT DOWN OR AUTO DOWN POSITION

P4 POWER WINDOW MASTER SW

4-GROUND: ALWAYS CONTINUITY

3-GROUND: APPROX. 12VOLTS WITH IGNITION SW AT ON POSITION

WINDOW LOCK SW

OPEN WITH WINDOW LOCK SW AT LOCK POSITION

S

○ : PARTS LOCATION

CODE	SEE PAGE	CODE	SEE PAGE	CODE	SEE PAGE
P2	21	P4	21	P6	21
P3	21	P5	21		21

T

○ : RELAY BLOCKS

CODE	SEE PAGE	RELAY BLOCK (RELAY BLOCK LOCATION)
1	16	R/B NO.1 (INSTRUMENT PANEL LEFT SIDE)

U

● : JUNCTION BLOCK AND WIRE HARNESS CONNECTOR

CODE	SEE PAGE	JUNCTION BLOCK AND WIRE HARNESS (CONNECTOR LOCATION)
3B	14	J/B NO.3 AND COWL WIRE (INSTRUMENT PANEL LEFT SIDE)

V

□ : CONNECTOR JOINING WIRE HARNESS AND WIRE HARNESS

CODE	SEE PAGE	JOINING WIRE HARNESS AND WIRE HARNESS (CONNECTOR LOCATION)
ID1	26	FRONT DOOR RH WIRE AND COWL WIRE (RIGHT KICK PANEL)
IH1	26	FRONT DOOR LH WIRE AND COWL WIRE (LEFT KICK PANEL)

W

▽ : GROUND POINTS

CODE	SEE PAGE	GROUND POINT LOCATION
IC	24	COWL LEFT

X

○ : SPLICE POINTS

CODE	SEE PAGE	WIRE HARNESSES WITH SPLICE POINTS
16	24	COWL WIRE

Ⓚ: Explains the system outline.

Ⓡ: Indicates values or explains the function for reference during troubleshooting.

Ⓢ: Indicates the reference page showing the position on the vehicle of the parts in the system circuit.

Example: Part "P4" (Power Window Master SW) is on page 21 of the manual.

* The letter in the code is from the first letter of the part, and the number indicates its order in parts starting with that letter.

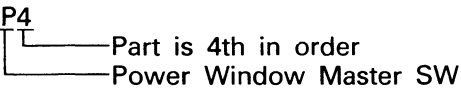
Example: P4

Ⓣ: Indicates the reference page showing the position on the vehicle of Relay Block Connectors in the system circuit.

Example: Connector "1" is described on page 16 of this manual and is installed on the left side of the instrument panel.

Ⓤ: Indicates the reference page showing the position on the vehicle of J/B and Wire Harness in the system circuit.

Example: Connector "3B" connects the Cowl Wire and J/B No. 3. It is described on page 14 of this manual, and is installed on the instrument panel left side.

Ⓥ: Indicates the reference page describing the wiring harness and wiring harness connector (the female wiring harness is shown first, followed by the male wiring harness).

Example: Connector "ID1" connects the front door RH wire (female) and cowl wire (male). It is described on page 26 of this manual, and is installed on the right side kick panel.

Ⓦ: Indicates the reference page showing the position of the ground points on the vehicle.

Example: Ground point "IC" is described on page 24 of this manual and is installed on the cowl left side.

Ⓧ: Indicates the reference page showing the position of the splice points on the vehicle.

Example: Splice point "I 5" is on the Cowl Wire Harness and is described on page 24 of this manual.

B HOW TO USE THIS MANUAL

The "Current Flow Chart" section, describes which parts each power source (fuses, fusible links, and circuit breakers) transmits current to. In the Power Source circuit diagram, the conditions when battery power is supplied to each system are explained. Since all System Circuit diagrams start from the power source, the power source system must be fully understood.

H POWER SOURCE (Current Flow Chart)

The chart below shows the route by which current flows from the battery to each electrical source (Fusible Link, Circuit Breaker, Fuse, etc.) and other parts.

The next page and following pages shown the parts to which each electrical source outputs current.

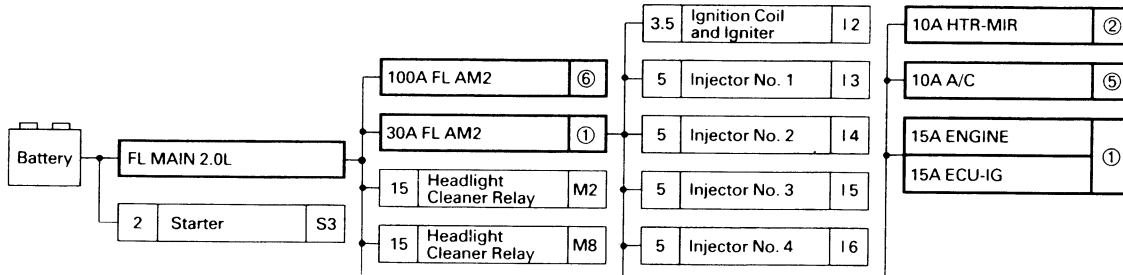

Location	CB or Fuse	Parts	Code or Location	Page Nos. of Related Systems
	A1	A/C Idle-Up VSV		32
	A4	Air Flow Meter		5
	A5	Alternator		3
	A7	Auto Antenna Motor		28
	A8	A/C Amplifier		32
	A9	A/C SW		32
	A10	A/C SW Light		10
	A11	A/C Pressure SW		32
	A12	ADD Control Relay		25
	O9	Auto Antenna Control Relay		28
	B1	A/T Indicator Light		10
	B3	Back-Up Light SW		12
	B4	Back-Up Light Relay		12
	B5	Blower Motor		32
	R5	Blower Resistor		32
	R6	Back-Up Light LH		12
	C2	Back-Up Light RH		12
	C3	Choke Heater		6
	C8	Check Connector		5
	C8	Cigarette Lighter		30
	C9	Cigarette Lighter Light		10
	C9	Circuit Opening Relay		5



POWER SOURCE

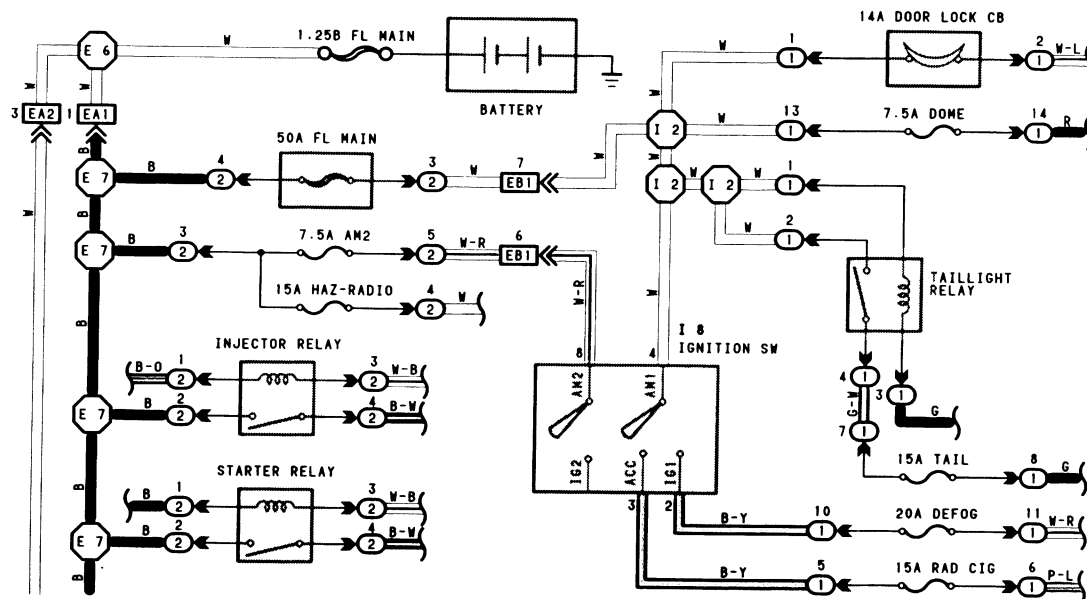

* The system shown here is an EXAMPLE ONLY. It is different to the actual circuit shown in the SYSTEM CIRCUITS SECTION.

The ground points circuit diagram shows the connections from all major parts to the respective ground points. When troubleshooting a faulty ground point, checking the system circuits which use a common ground may help you identify the problem ground quickly. The relationship between ground points (∇_{EA} , ∇_{IB} and ∇_{IC} shown below) can also be checked this way.

J GROUND POINTS

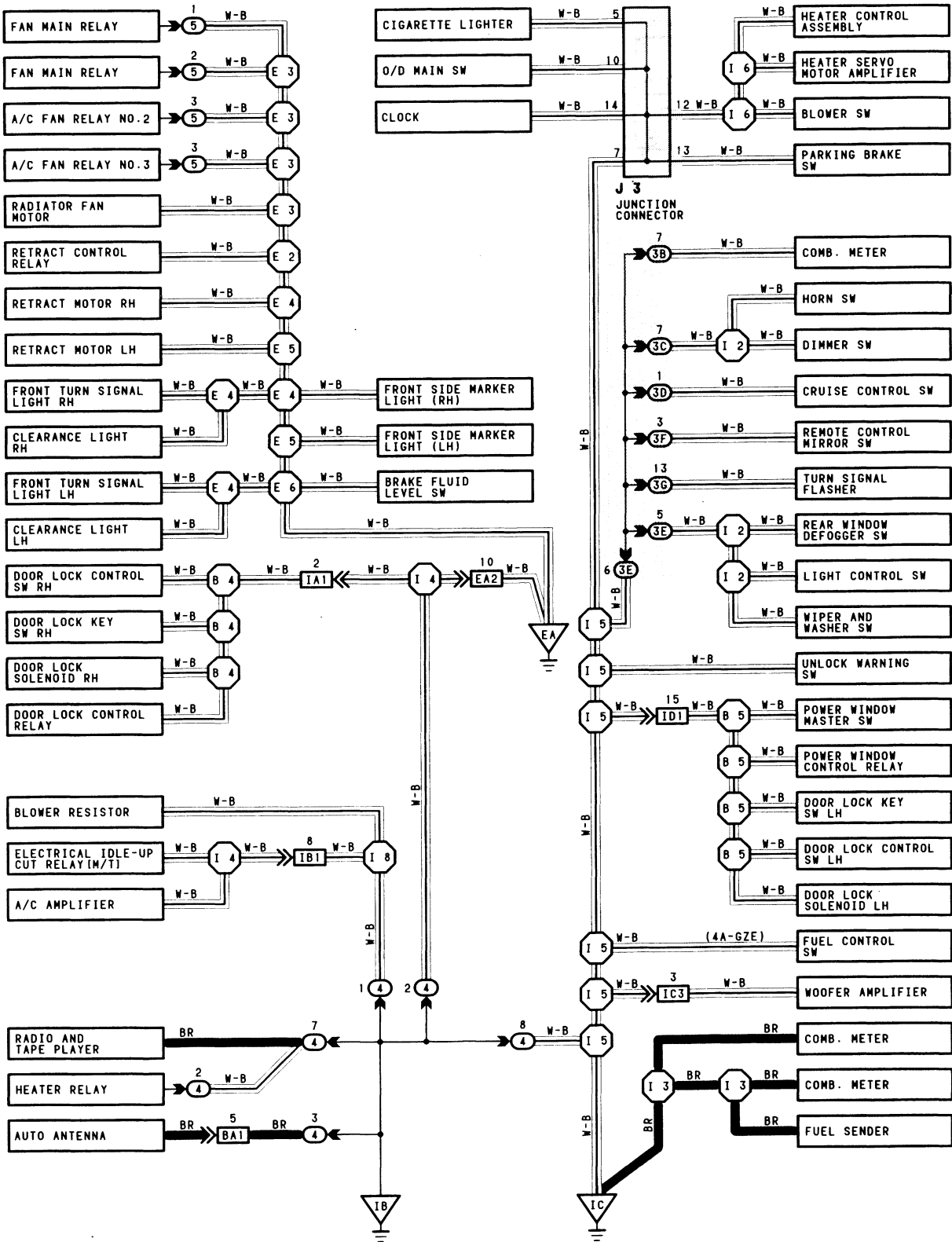

* The system shown here is an EXAMPLE ONLY. It is different to the actual circuit shown in the SYSTEM CIRCUITS SECTION.

C TROUBLESHOOTING

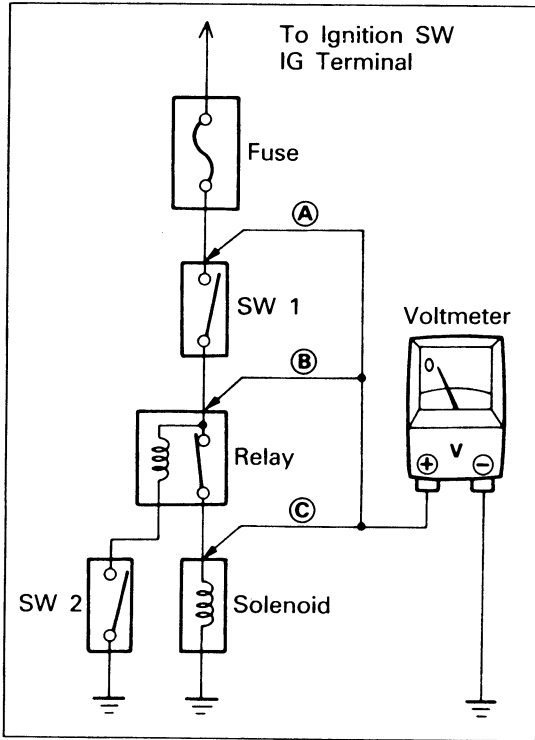

VOLTAGE CHECK

- (a) Establish conditions in which voltage is present at the check point.

Example:

- Ⓐ – Ignition SW on
 - Ⓑ – Ignition SW and SW 1 on
 - Ⓒ – Ignition SW, SW 1 and Relay on (SW 2 off)
- (b) Using a voltmeter, connect the negative lead to a good ground point or negative battery terminal, and the positive lead to the connector or component terminal. This check can be done with a test light instead of a voltmeter.

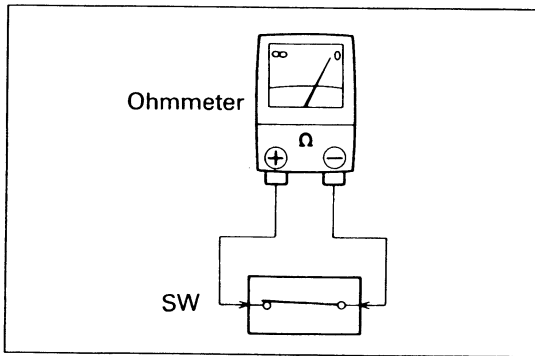

CONTINUITY AND RESISTANCE CHECK

- (a) Disconnect the battery terminal or wire so there is no voltage between the check points.
- (b) Contact the two leads of an ohmmeter to each of the check points.

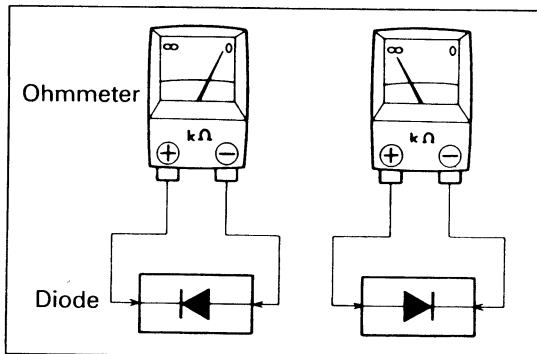

If the circuit has diodes, reverse the two leads and check again.

When contacting the negative lead to the diode positive side and the positive lead to the negative side, there should be continuity.

When contacting the two leads in reverse, there should be no continuity.

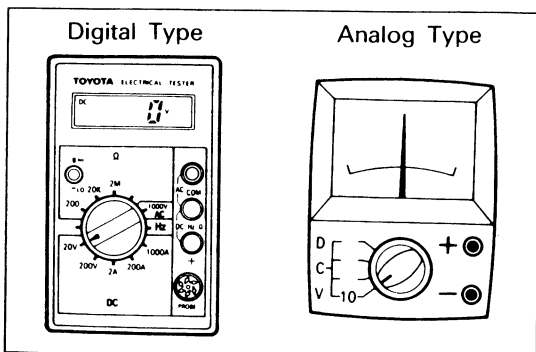

- (c) Use a volt/ohmmeter with high impedance (10 kΩ/V minimum) for troubleshooting of the electrical circuit.

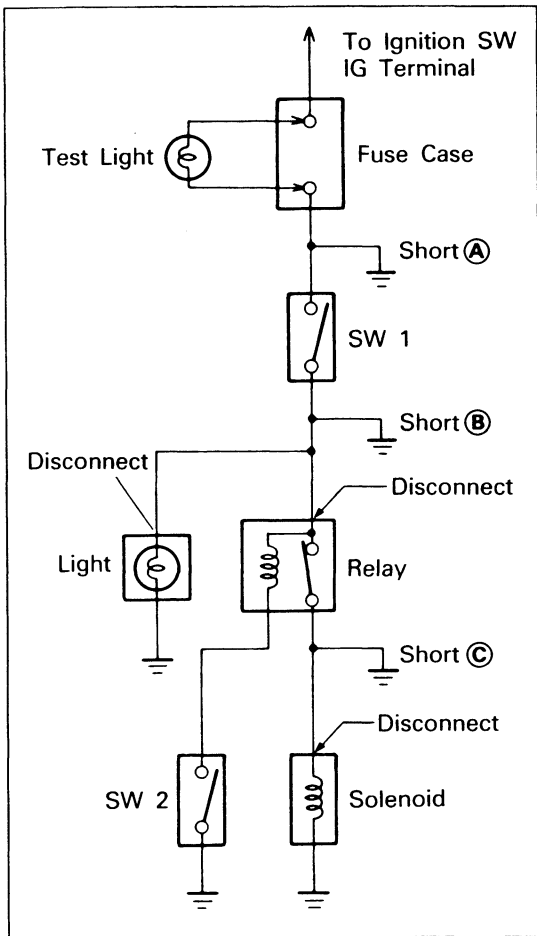

FINDING A SHORT CIRCUIT

- Remove the blown fuse and disconnect all loads of the fuse.
- Connect a test light in place of the fuse.
- Establish conditions in which the test light comes on.

Example:

- Ignition SW on
 - Ignition SW and SW 1 on
 - Ignition SW, SW 1 and Relay on (Connect the Relay) and SW 2 off (or Disconnect SW 2)
- Disconnect and reconnect the connectors while watching the test light.
The short lies between the connector where the test light stays lit and the connector where the light goes out.
 - Find the exact location of the short by lightly shaking the problem wire along the body.

CAUTION:

Do not open the cover or the case of the ECU unless absolutely necessary. (If the IC terminals are touched, the IC may be destroyed by static electricity.)

DISCONNECTION OF MALE AND FEMALE CONNECTORS

To pull apart the connectors, pull on the connector itself, not the wire harness.

HINT: Check to see what kind of connector you are disconnecting before pulling apart.

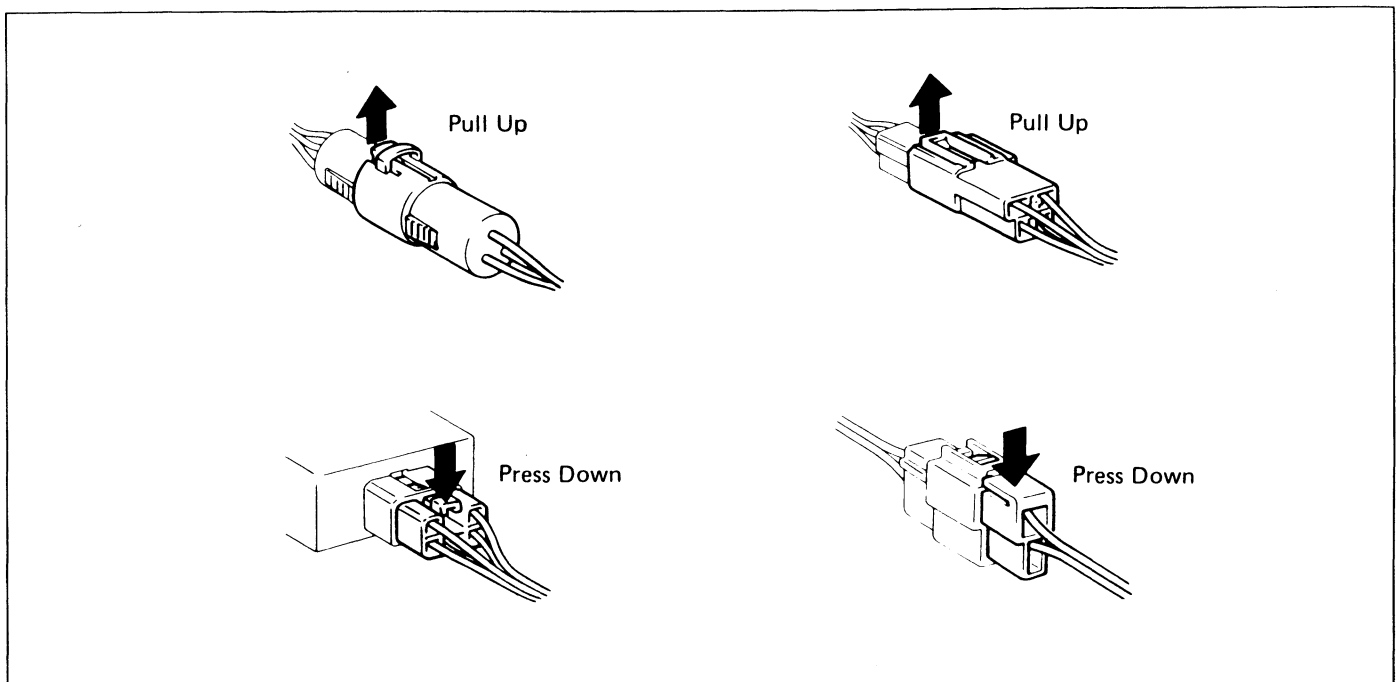

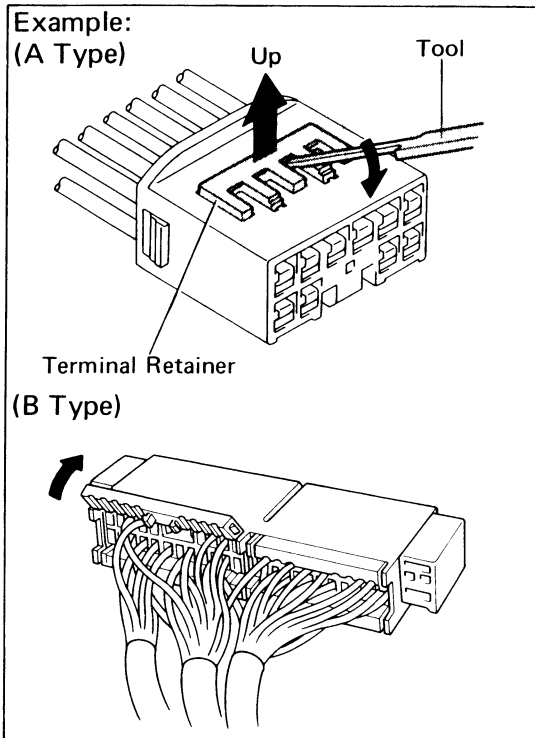

HOW TO REPLACEMENT FOR TERMINAL (with Terminal Retainer Type)

1. DISCONNECT CONNECTOR
2. DISCONNECT TERMINAL FROM CONNECTOR
 - (a) "for A type"

Raise the terminal retainer up to the temporarily lock position.

HINT: The needle insertion position varies according to the connector's shape (number of terminals etc.), so check the position before inserting it.

"for B type"

Open the terminal retainer.

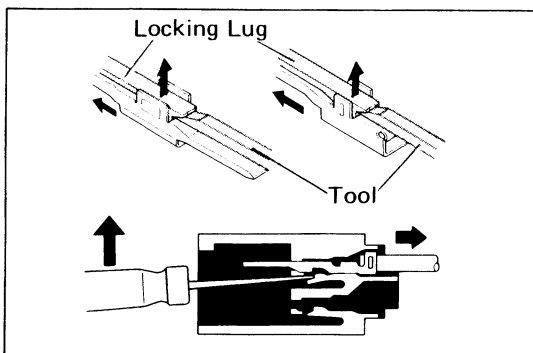

- (b) Release the locking lug from terminal and pull the terminal out from rear.

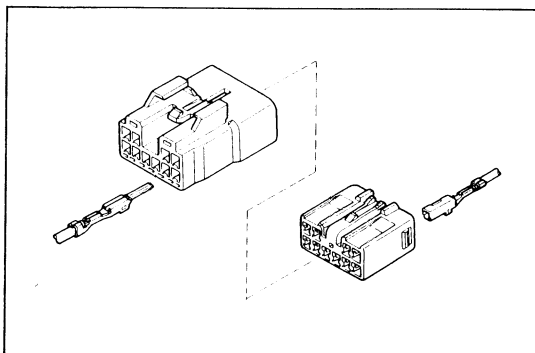

3. INSTALL TERMINAL TO CONNECTOR
 - (a) Insert the terminal.

HINT:

1. Make sure the terminal is positioned correctly.
2. Insert the terminal until the locking lug locks firmly.
3. Insert the terminal with terminal retainer in the temporarily lock position.

- (b) Push the terminal retainer in as the full lock position.

4. CONNECT CONNECTOR

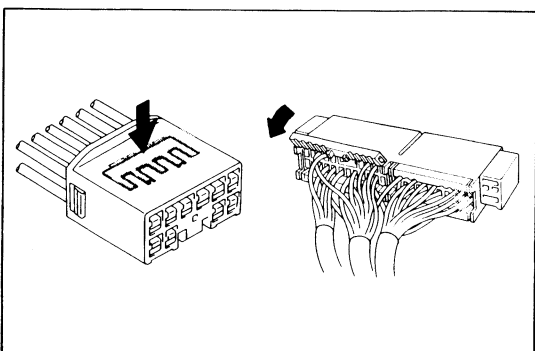











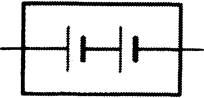

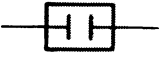

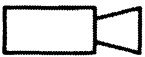
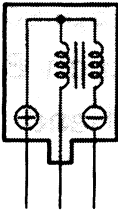

ABBREVIATIONS

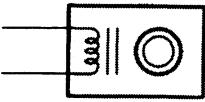

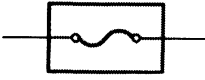

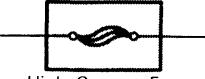
The following abbreviations are used in this manual.

A/C	= Air Conditioner
ABS	= Anti-Lock Brake System
A/T	= Automatic Transmission
COMB.	= Combination
ECT	= Electronic Controlled Transmission
ECU	= Electronic Control Unit
EFI	= Electronic Fuel Injection
EGR	= Exhaust Gas Recirculation
EX.	= Except
FL	= Fusible Link
ISC	= Idle Speed Control
J/B	= Junction Block
LH	= Left-Hand
M/T	= Manual Transmission
O/D	= Overdrive
R/B	= Relay Block
RH	= Right-Hand
SRS	= Supplemental Restraint System
SW	= Switch
TEMP.	= Temperature
VSV	= Vacuum Switching Valve
W/	= With
W/O	= Without

* The titles given inside the components are the names of the terminals (terminal codes) and are not treated as being abbreviations.

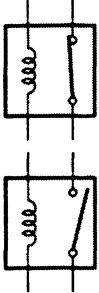
E GLOSSARY OF TERMS AND SYMBOLS

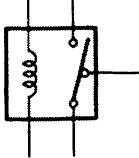
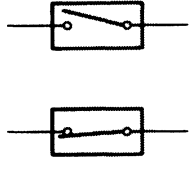
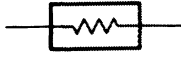
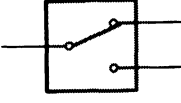
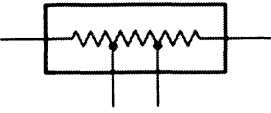
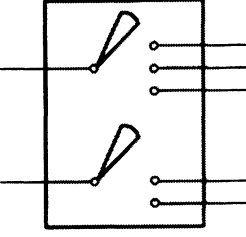
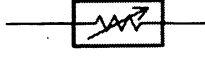
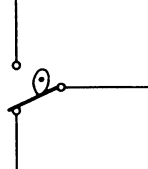
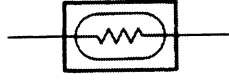
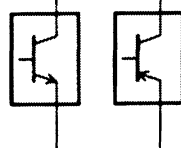
 <p>BATTERY Stores chemical energy and converts it into electrical energy. Provides DC current for the auto's various electrical circuits.</p>	<p>HEADLIGHTS</p> <p>1. SINGLE FILAMENT Current flow causes a headlight filament to heat up and emit light. A headlight may have either a single (1) filament or a double (2) filament.</p>  <p>2. DOUBLE FILAMENT</p> 
 <p>CAPACITOR (Condenser) A small holding unit for temporary storage of electrical voltage.</p>	<p>HORN An electric device which sounds a loud audible signal.</p> 
 <p>CIGARETTE LIGHTER An electric resistance heating element.</p>	<p>IGNITION COIL Converts low-voltage DC current into high-voltage ignition current for firing the spark plugs.</p> 
 <p>CIRCUIT BREAKER Basically a reusable fuse, a circuit breaker will heat and open if too much current flows through it. Some units automatically reset when cool, others must be manually reset.</p>	<p>DIODE A semiconductor which allows current flow in only one direction.</p> 
<p>DIODE, ZENER</p>  <p>A diode which allows current flow in one direction but blocks reverse flow only up to a specific voltage. Above that potential, it passes the excess voltage. This acts as a simple voltage regulator.</p>	<p>LIGHT Current flow through a filament causes the filament to heat up and emit light.</p> 
<p>DISTRIBUTOR, IIA Channels high-voltage current from the ignition coil to the individual spark plugs.</p> 	<p>LED (LIGHT EMITTING DIODE) Upon current flow, these diodes emit light without producing the heat of a comparable light.</p> 
<p>FUSE A thin metal strip which burns through when too much current flows through it, thereby stopping current flow and protecting a circuit from damage.</p>  <p>(for Medium Current Fuse)</p>	<p>METER, ANALOG Current flow activates a magnetic coil which causes a needle to move, thereby providing a relative display against a background calibration.</p> 
<p>FUSIBLE LINK A heavy-gauge wire placed in high amperage circuits which burns through on overloads, thereby protecting the circuit.</p>  <p>(for High Current Fuse or Fusible Link)</p>	<p>METER, DIGITAL Current flow activates one or many LED's, LCD's, or fluorescent displays, which provide a relative or digital display.</p> 
<p>GROUND The point at which wiring attaches to the Body, thereby providing a return path for an electrical circuit; without a ground, current cannot flow.</p> 	<p>MOTOR A power unit which converts electrical energy into mechanical energy, especially rotary motion.</p> 

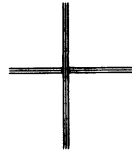
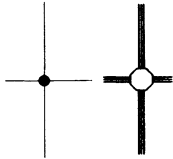
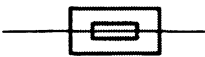
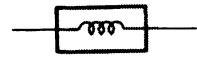
<p>RELAY</p>  <p>1. NORMALLY CLOSED</p> <p>2. NORMALLY OPEN</p> <p>Basically, an electrically operated switch which may be normally closed (1) or open (2). Current flow through a small coil creates a magnetic field which either opens or closes an attached switch.</p>	 <p>SPEAKER</p> <p>An electromechanical device which creates sound waves from current flow.</p>
 <p>RELAY, DOUBLE THROW</p> <p>A relay which passes current through one set of contacts or the other.</p>	<p>SWITCH, MANUAL</p>  <p>1. NORMALLY OPEN</p> <p>2. NORMALLY CLOSED</p> <p>Opens and closes circuits, thereby stopping (1) or allowing (2) current flow.</p>
 <p>RESISTOR</p> <p>An electrical component with a fixed resistance, placed in a circuit to reduce voltage to a specific value.</p>	<p>SWITCH, DOUBLE THROW</p>  <p>A switch which continuously passes current through one set of contacts or the other.</p>
 <p>RESISTOR, TAPPED</p> <p>A resistor which supplies two or more different non-adjustable resistance values.</p>	<p>SWITCH, IGNITION</p>  <p>A key operated switch with several positions which allow various circuits. Particularly the primary ignition circuit, to become operational.</p>
 <p>RESISTOR, VARIABLE or RHEOSTAT</p> <p>A controllable resistor with a variable rate of resistance. Also called a potentiometer or rheostat.</p>	<p>SWITCH, WIPER PARK</p>  <p>Automatically returns wipers to the stop position when the wiper switch is turned off.</p>
 <p>SENSOR (Thermistor)</p> <p>A resistor which varies its resistance with temperature.</p>	<p>TRANSISTOR</p>  <p>A solidstate device typically used as an electronic relay; stops or passes current depending on the applied voltage at "base".</p>
 <p>SENSOR, ANALOG SPEED</p> <p>Uses magnetic impulses to open and close a switch to create a signal for activation of other components.</p>	<p>WIRES</p> <p>(1) NOT CONNECTED</p>  <p>(2) SPLICED</p>  <p>Wires are always drawn as straight lines on wiring diagrams. Crossed wires (1) without a black dot at the junction are not joined; crossed wires (2) with a black dot or octagonal (O) mark at the junction are spliced (joined) connections.</p>
 <p>SHORT PIN</p> <p>Used to provide an unbroken connection within a junction block.</p>	<p>SOLENOID</p>  <p>An electromagnetic coil which forms a magnetic field when current flow, to move a plunger, etc.</p>

F RELAY LOCATIONS

[Body]

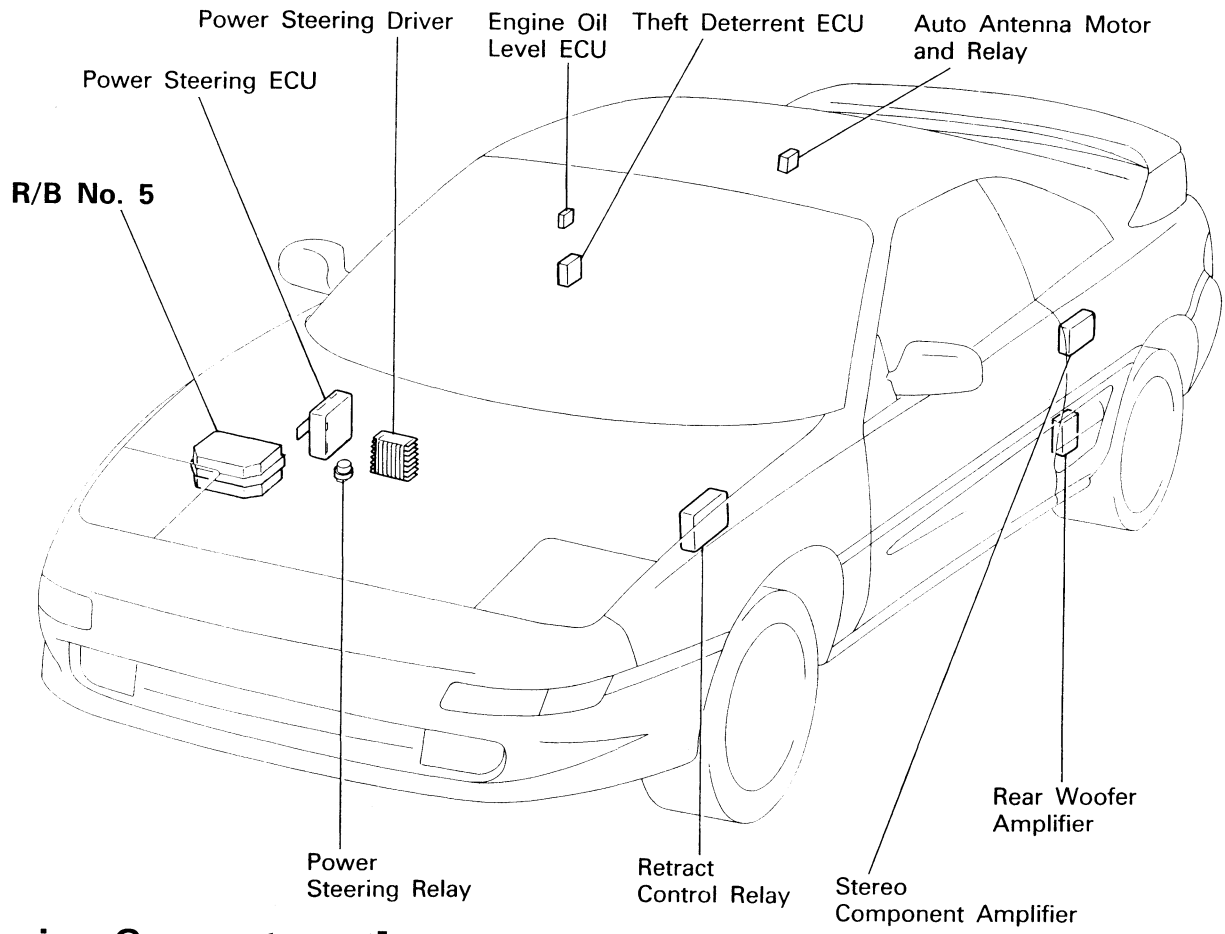

[Engine Compartment]

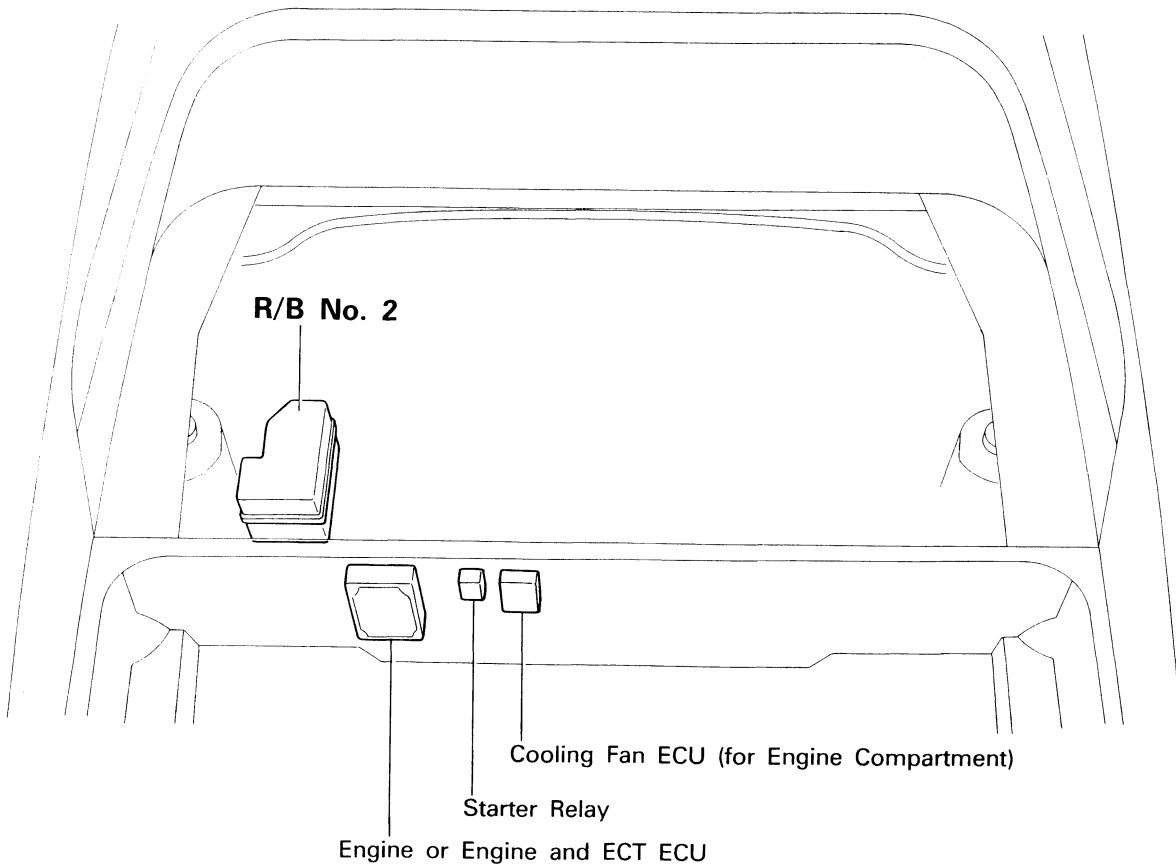

[Instrument Panel]

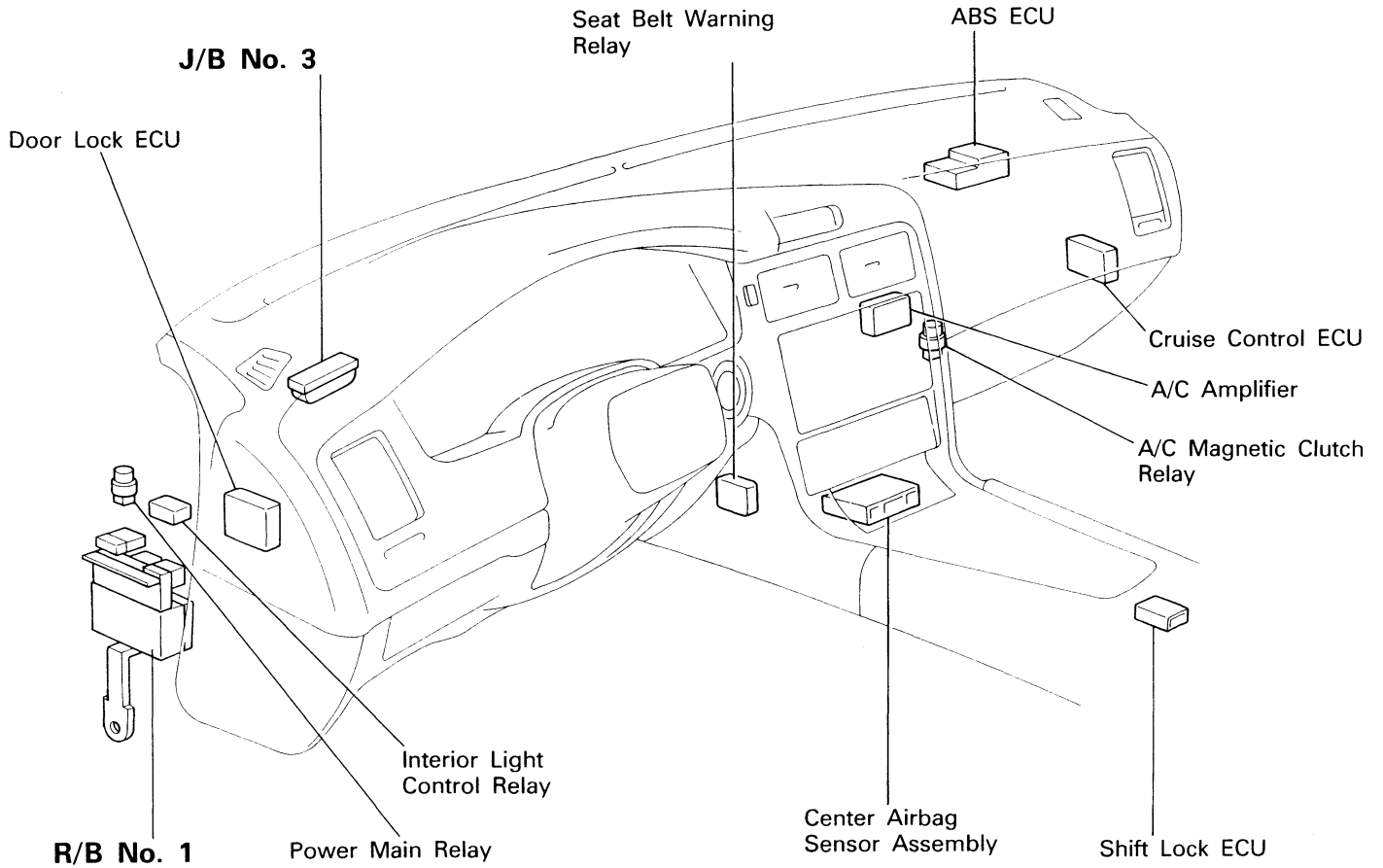

⑤ : R/B No. 5 Front Luggage Compartment Right (See Page 16)

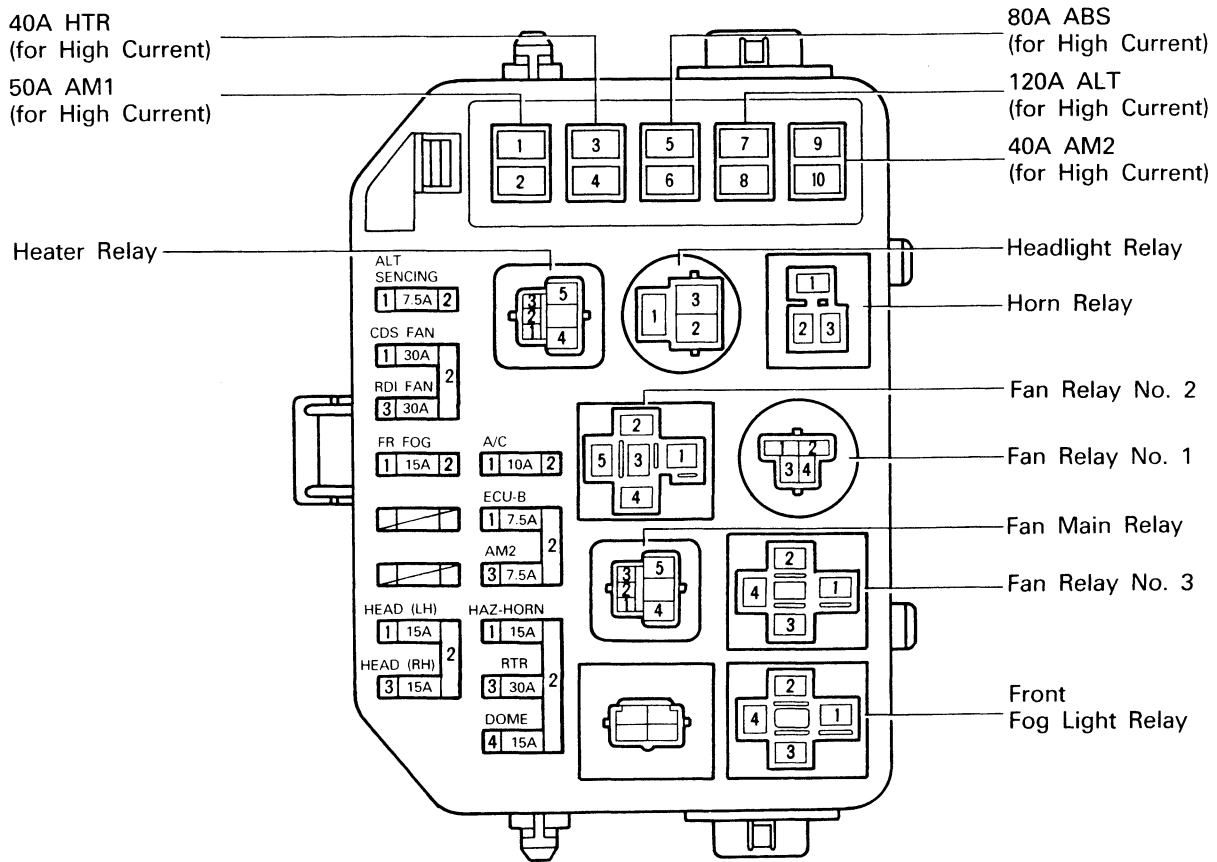

F RELAY LOCATIONS

① : R/B No. 1 | Left Kick Panel (See page 17)

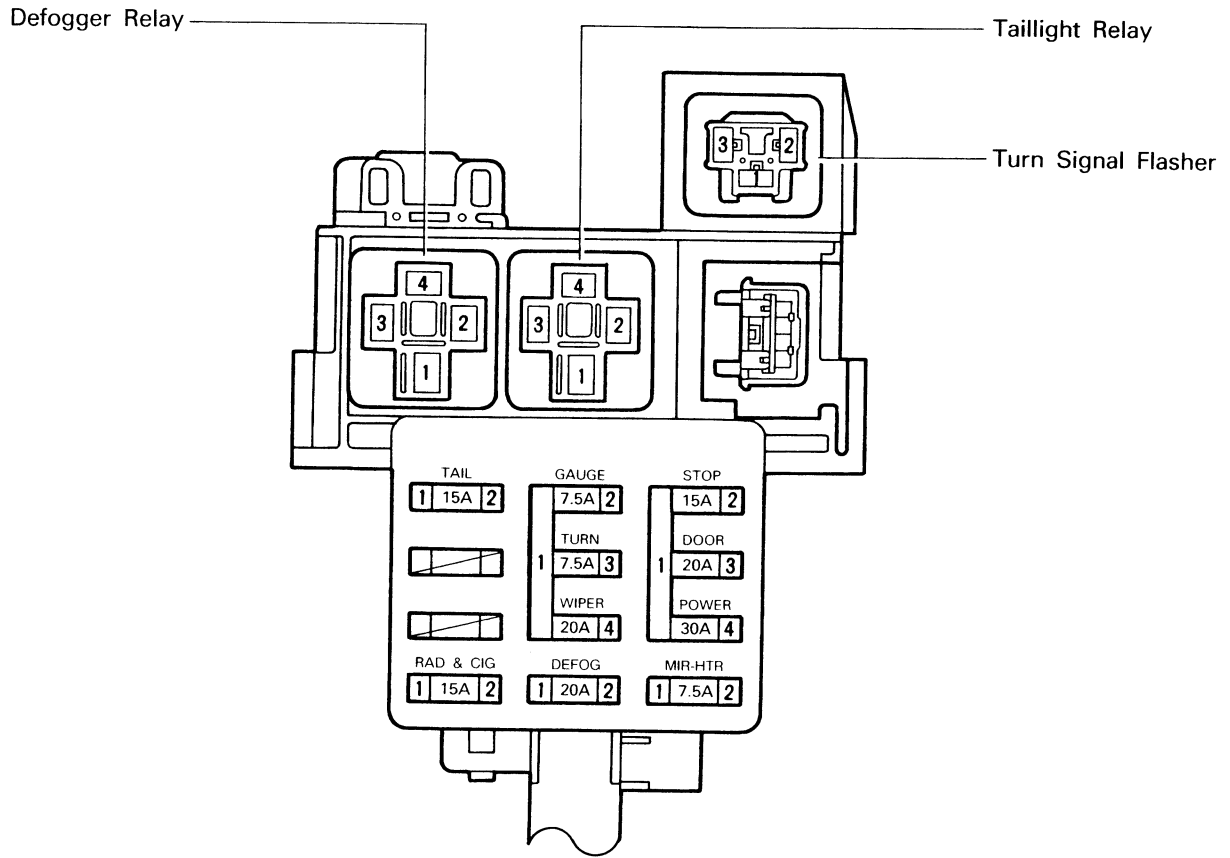

② : R/B No. 2 | Engine Compartment Left (See Page 16)

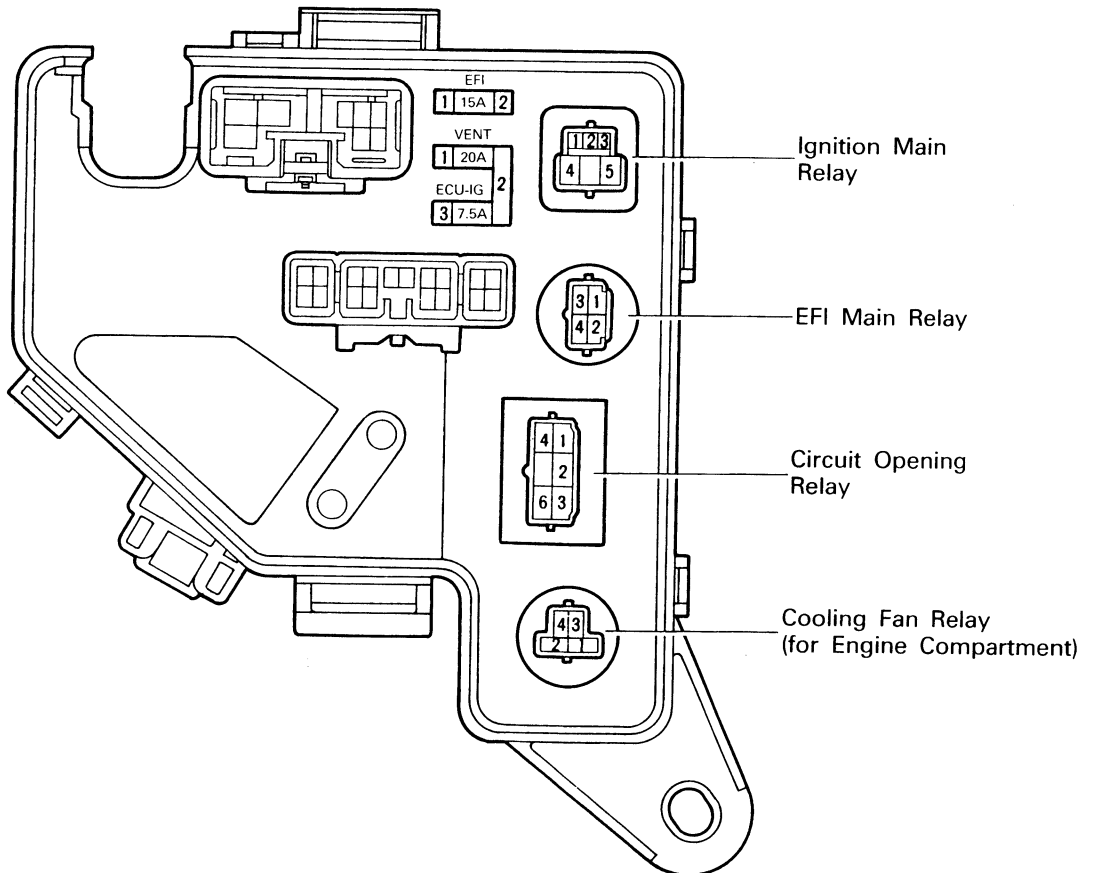

Position of Parts in Engine Compartment

[3S-GTE]

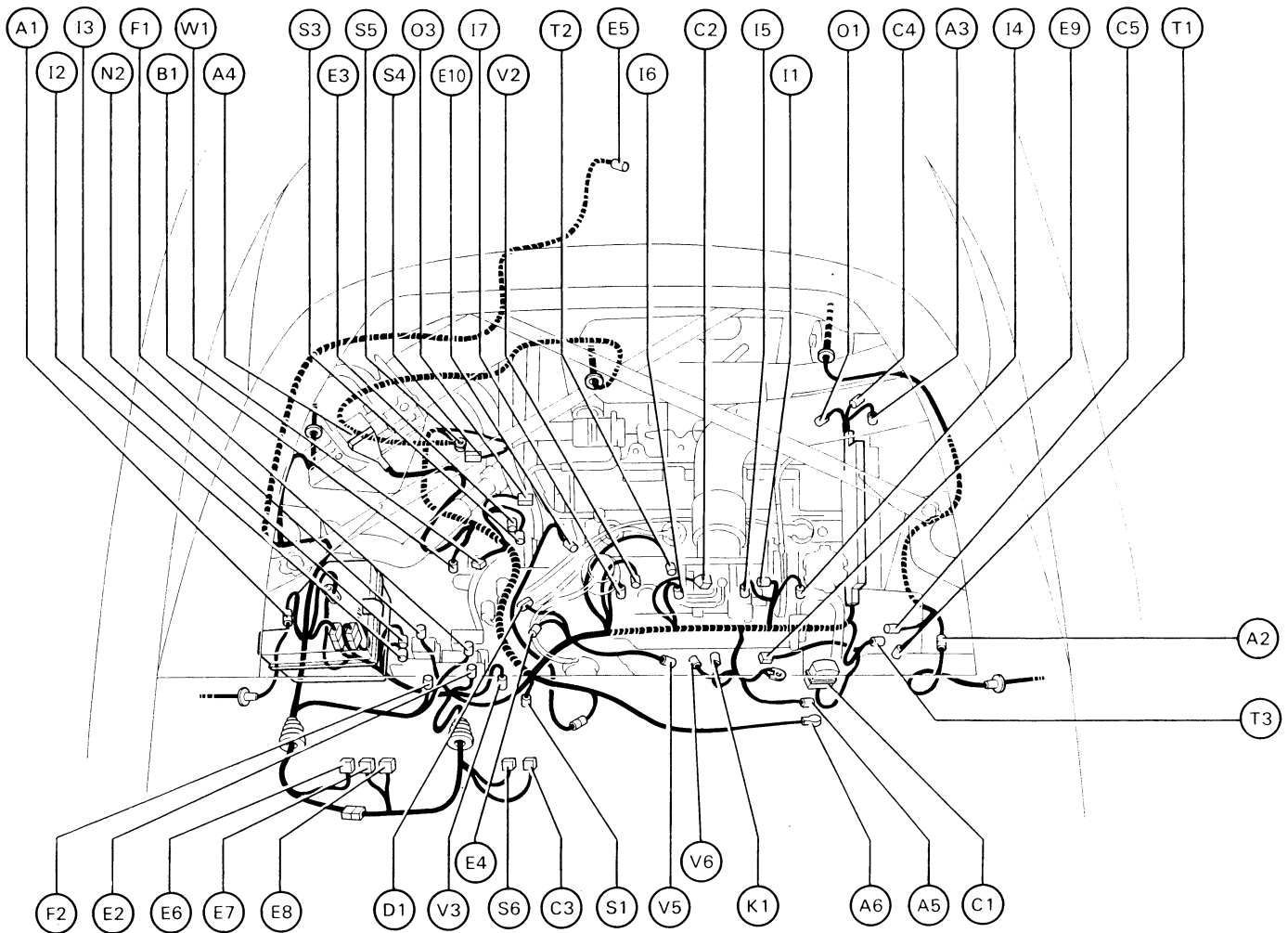

K 1 Knock Sensor (3S-GTE)

N 1 Neutral Start SW and Back-Up Light SW
(A/T of 5S-FE)

N 2 Noise Filter (for Ignition System)

O 1 Oxygen Sensor (Main)

O 2 Oxygen Sensor (Sub of 5S-FE)

O 3 Oil Pressure SW

S 1 Speed Sensor (for Cruise Control System)

S 2 Speed Sensor (for ECT System of 5S-FE)

S 3 Start-Injector Time SW

S 4 } Starter

S 5 } Starter

S 6 Starter Relay

T 1 Theft Deterrent Horn

T 2 Throttle Position Sensor

T 3 Turbo Pressure Sensor (3S-GTE)

V 1 Vacuum Sensor (5S-FE)

V 2 VSV (for EGR System)

V 3 VSV (for A/C Idle-Up System)

V 4 VSV (for Fuel Pressure Up Control System)

V 5 VSV (for Turbo Pressure Control System)

V 6 VSV (for T-VIS)

W 1 Water Temp. Sender

G ELECTRICAL WIRING ROUTING

Position of Parts in Instrument Panel

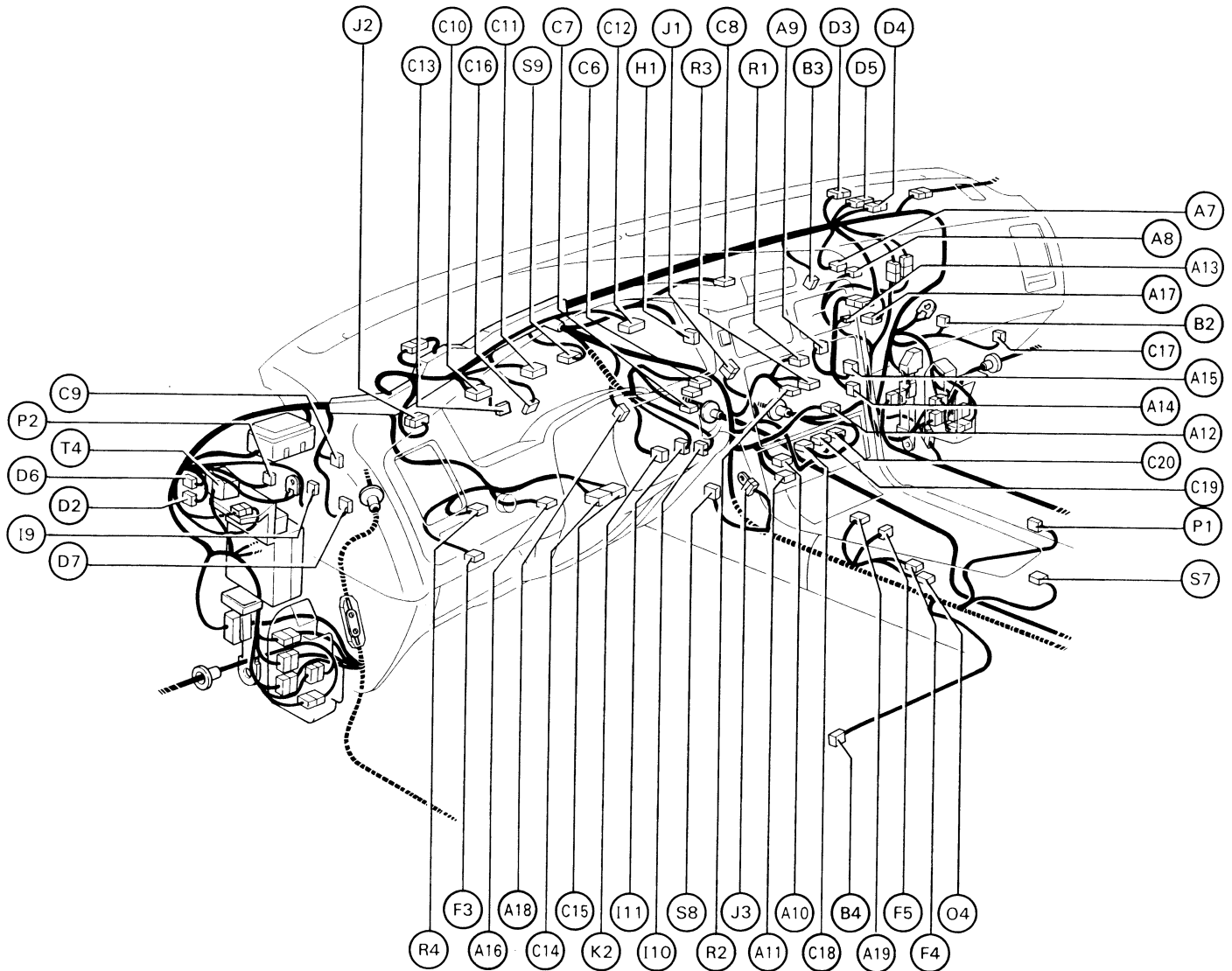

- | | | |
|--|--|--|
| A 7 } ABS ECU | C 13 } Combination Meter (A/T Indicator Light) | I 9 } Interior Light Control Relay |
| A 8 } ABS ECU | C 14 } Combination SW | I 10 } Ignition Key Cylinder Light |
| A 9 } A/C Amplifier | C 15 } Combination SW | I 11 } Ignition SW and Unlock Warning SW |
| A 10 } A/C Control Assembly | C 16 } Cruise Control Clutch SW | J 1 } Junction Connector |
| A 11 } A/C Control Assembly | C 17 } Cruise Control ECU | J 2 } Junction Connector |
| A 12 } A/C Control Assembly | C 18 } Center Airbag Sensor Assembly | J 3 } Junction Connector (for Earth) |
| A 13 } A/C Dual Pressure SW | C 19 } Center Airbag Sensor Assembly | K 2 } Key Inter Lock Solenoid |
| A 14 } A/C Thermistor | C 20 } Center Airbag Sensor Assembly | O 4 } O/D Main SW |
| A 15 } A/C Magnetic Clutch Relay | D 2 } Diode (for Electrical Idle-Up System) | P 1 } Parking Brake SW |
| A 16 } Airbag Squib | D 3 } Diode (for A/C System) | P 2 } Power Main Relay |
| A 17 } Air Inlet Servo Motor | D 4 } Diode (for Theft Deterrent System) | R 1 } Radio and Player (w/ CD Player) |
| A 18 } Air Vent Mode Control Servo Motor | D 5 } Diode (for Interior System) | R 2 } Radio and Player |
| A 19 } Ashtray Illumination | D 6 } Diode (for Power Window) | R 3 } (w/o CD Player) |
| B 2 } Blower Motor | D 7 } Door Lock ECU | R 4 } Rheostat |
| B 3 } Blower Resistor | F 3 } FOG LIGHT SW | S 7 } Shift Lock ECU |
| B 4 } Buckle SW | F 4 } Fuel Pump | S 8 } Seat Belt Warning Relay |
| C 6 } Cigarette Lighter | F 5 } Fuel Sender | S 9 } Stop Light SW or, Stop Light SW and Cruise Control Stop SW |
| C 7 } Cigarette Lighter Illumination | H 1 } Hazard SW | T 4 } Turn Signal Flasher |
| C 8 } Clock | | |
| C 9 } Clutch Start SW (M/T) | | |
| C 10 } Combination Meter | | |
| C 11 } Combination Meter | | |
| C 12 } Combination Meter | | |

G ELECTRICAL WIRING ROUTING

□ : Location of Connector Joining Wire Harness and Wire Harness

▽ : Location of Ground Points

[5S-FE]

Engine Room Main Wire

Floor Wire

Engine Wire and
Engine Room Main Wire

EA4

Engine Wire and
R/B No. 2

EB1

Engine Wire and
Engine Room Main Wire

EA3

Engine Wire
and
Engine Room
Main Wire

EA1

EA2

Engine Wire

EA

○ : Location of Splice Points

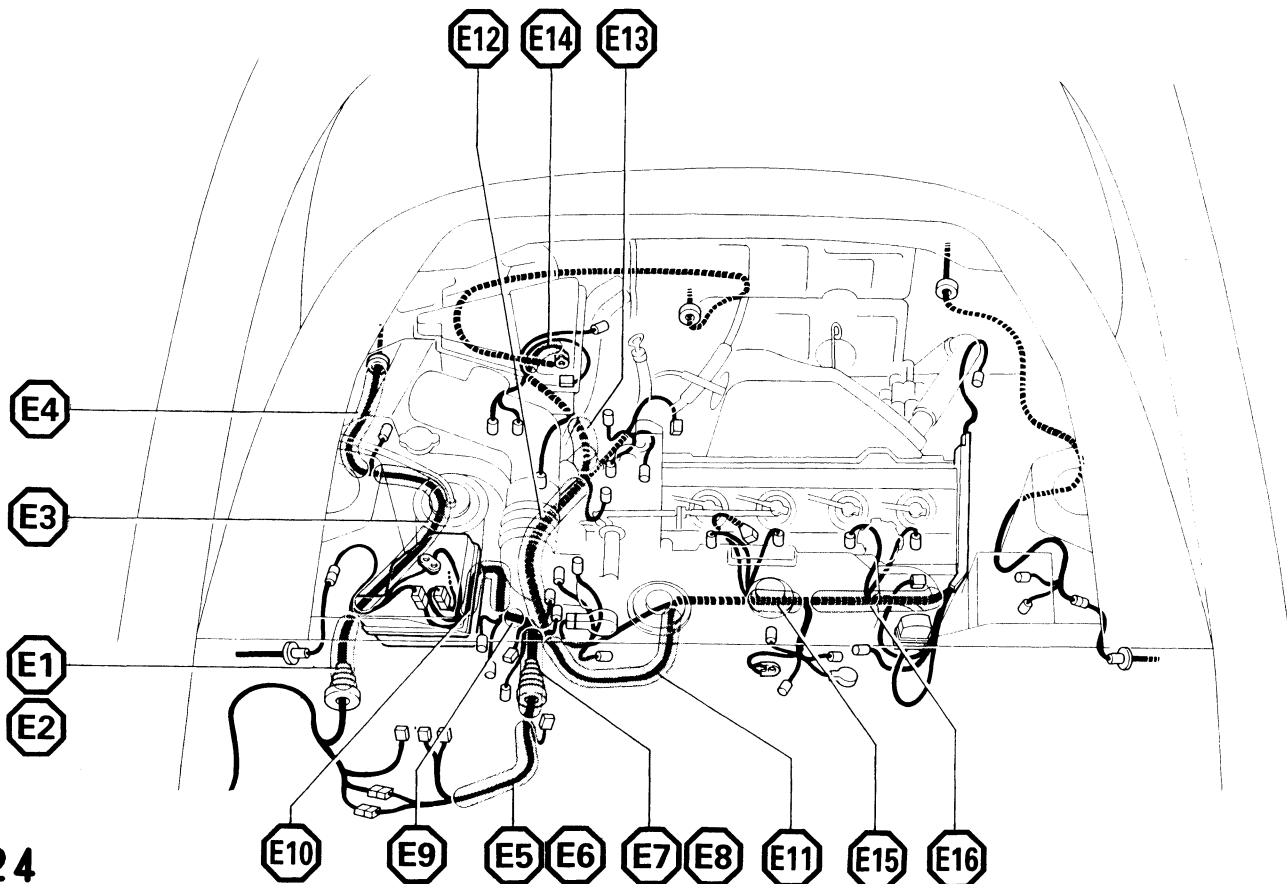

Connector Joining Wire Harness and Wire Harness

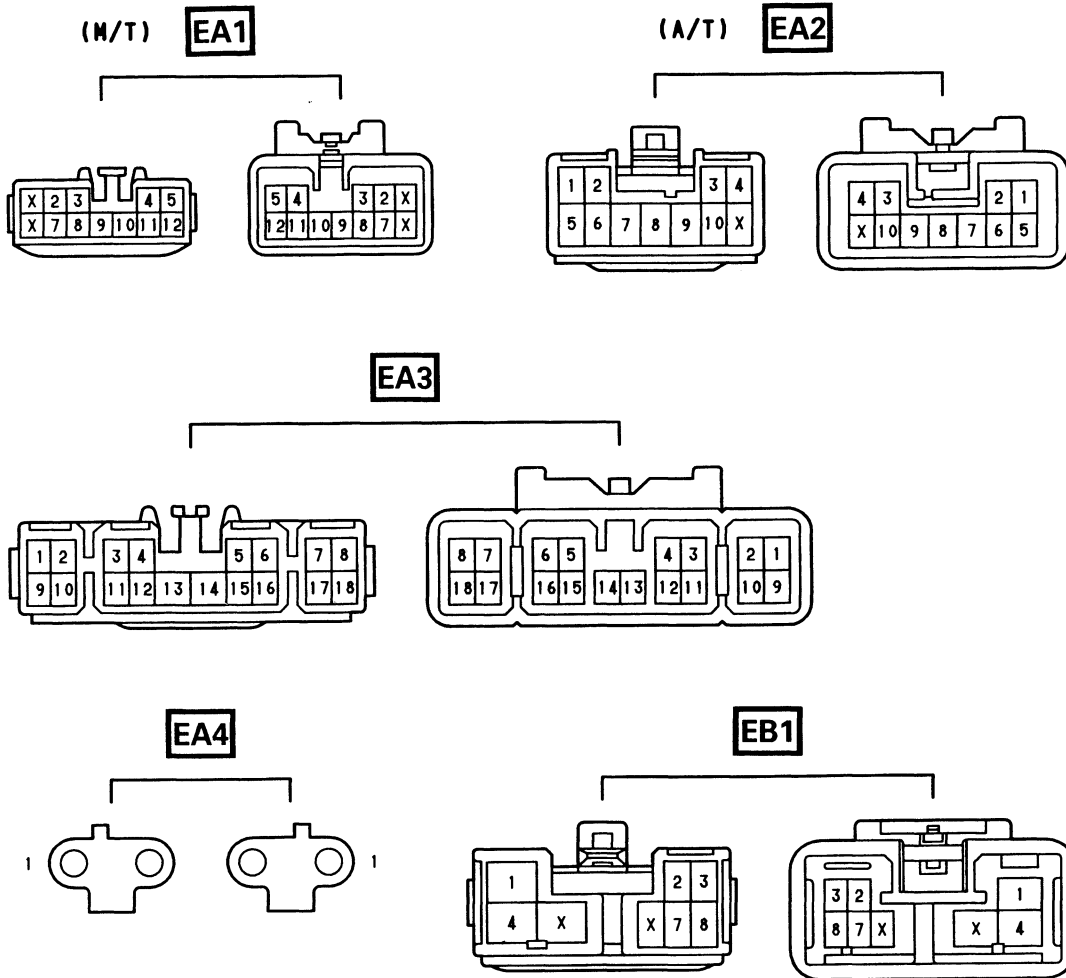

CODE	JOINING WIRE HARNESS AND WIRE HARNESS (CONNECTOR LOCATION)
EA1	ENGINE WIRE AND ENGINE ROOM MAIN WIRE (REAR LUGGAGE COMPARTMENT LEFT)
EA2	ENGINE WIRE AND ENGINE ROOM MAIN WIRE (R/B NO.2 INNER)
EA3	ENGINE WIRE AND ENGINE ROOM MAIN WIRE (R/B NO.2 INNER)
EA4	ENGINE WIRE AND ENGINE ROOM MAIN WIRE (R/B NO.2 INNER)
EB1	ENGINE WIRE AND R/B NO.2 (R/B NO.2 INNER)

G ELECTRICAL WIRING ROUTING

□ : Location of Connector Joining Wire Harness and Wire Harness

▽ : Location of Ground Points

[3S-GTE]

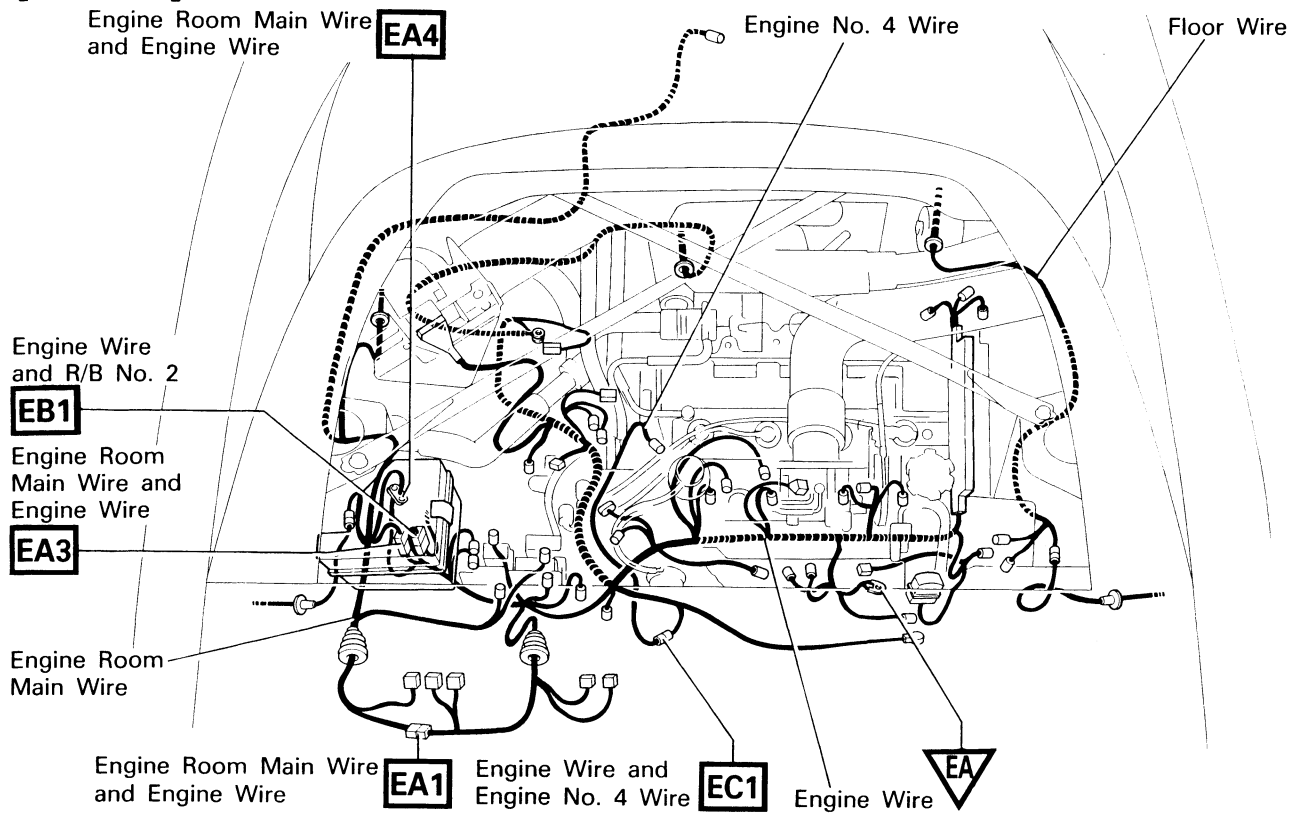

○ : Location of Splice Points

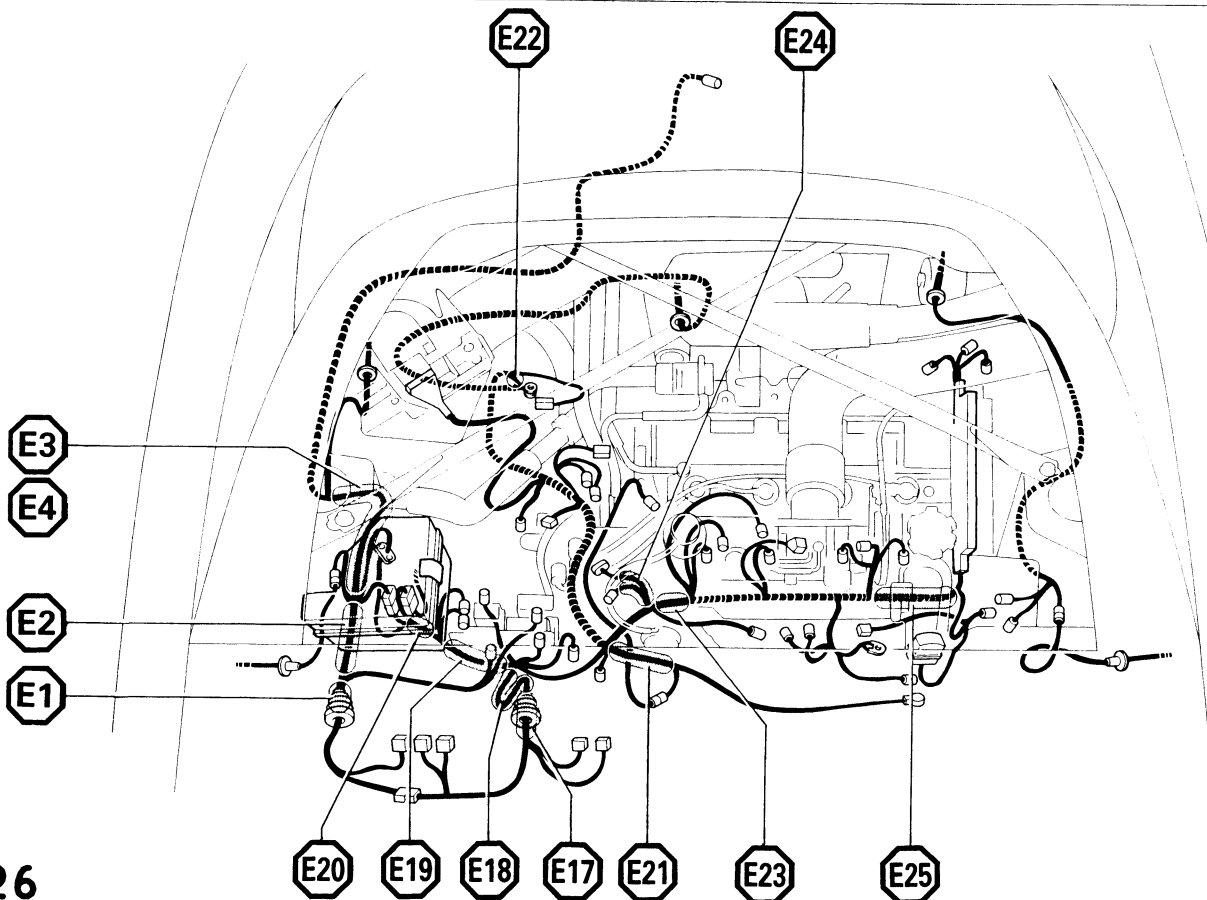

Connector Joining Wire Harness and Wire Harness

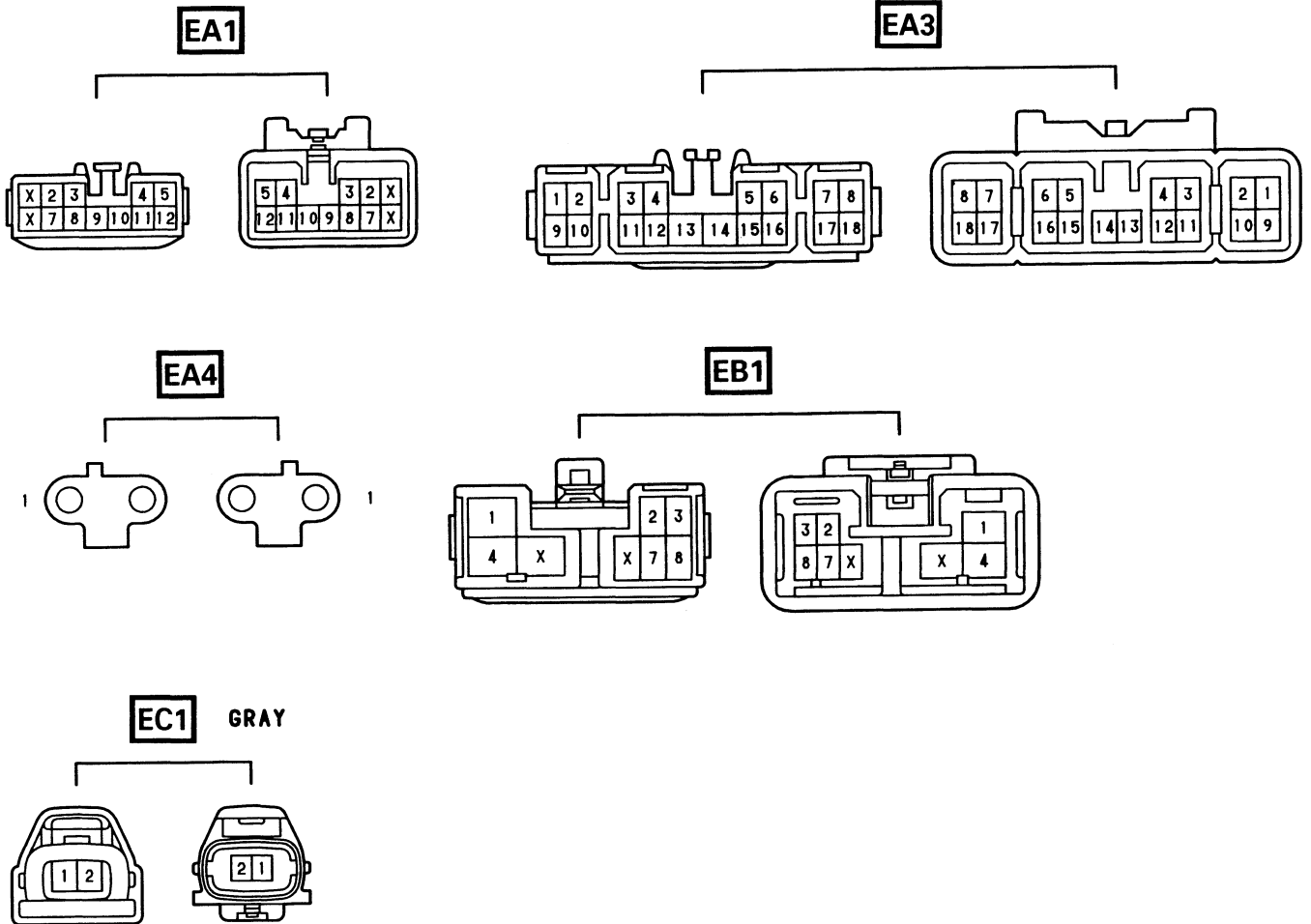

CODE	JOINING WIRE HARNESS AND WIRE HARNESS (CONNECTOR LOCATION)
EA1	ENGINE WIRE AND ENGINE ROOM MAIN WIRE (REAR LUGGAGE COMPARTMENT LEFT)
EA3	ENGINE WIRE AND ENGINE ROOM MAIN WIRE (R/B NO.2 INNER)
EA4	ENGINE WIRE AND R/B NO.2 (R/B NO.2 INNER)
EB1	ENGINE WIRE AND R/B NO.2 (R/B NO.2 INNER)
EC1	ENGINE NO.4 WIRE AND ENGINE WIRE (NEAR THE INTAKE MANIFOLD)

G ELECTRICAL WIRING ROUTING

□ : Location of Connector Joining Wire Harness and Wire Harness

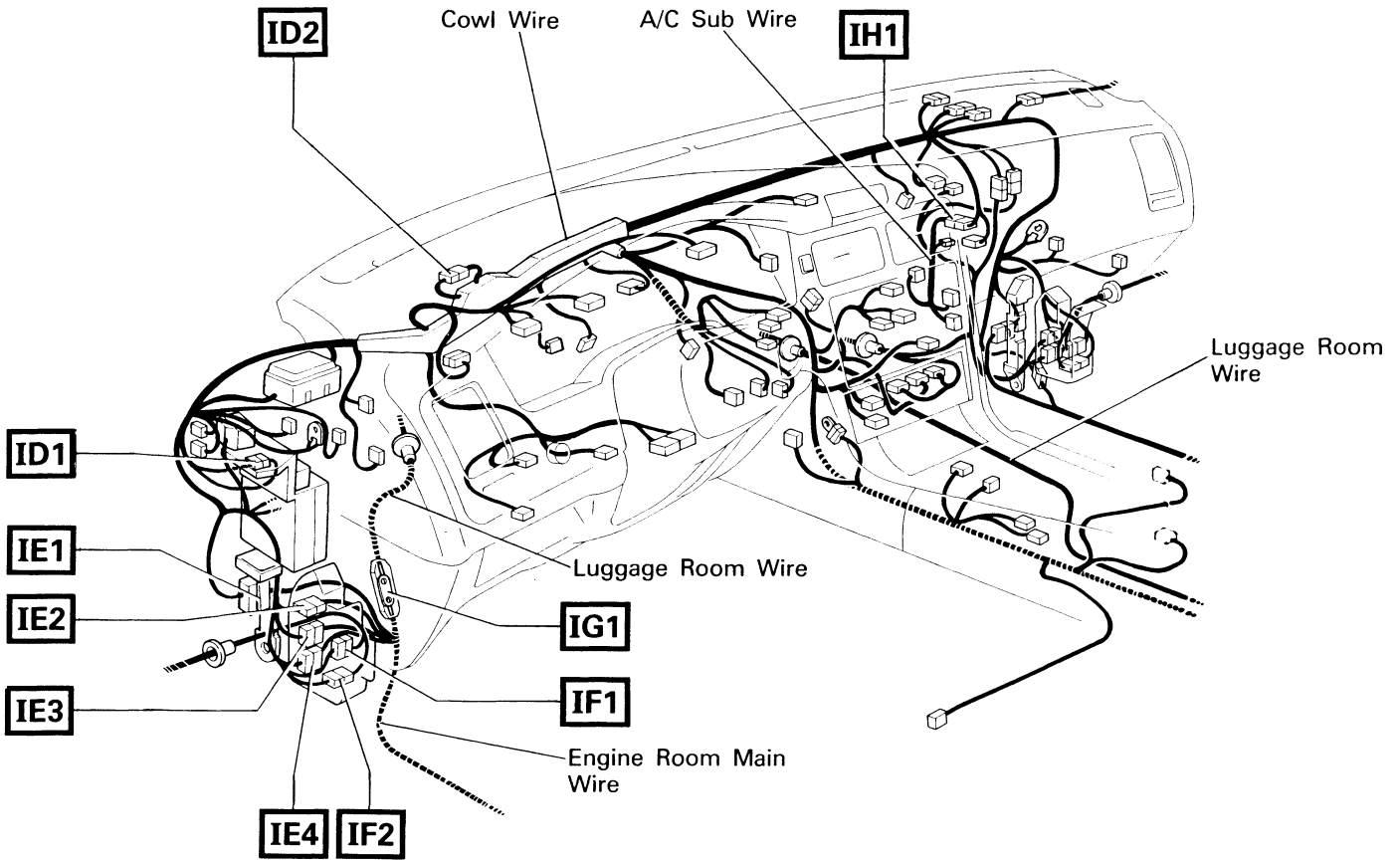

▽ : Location of Ground Points

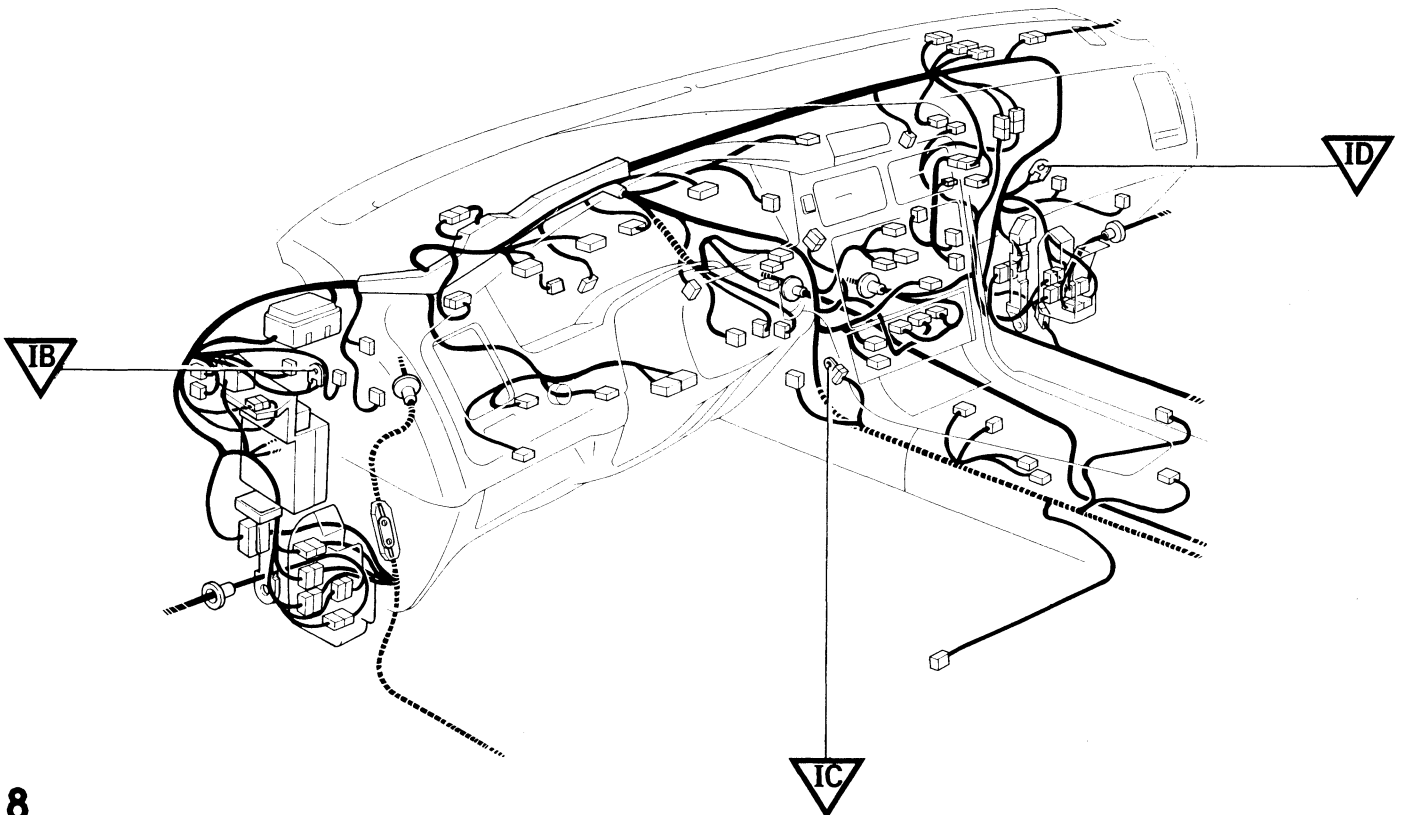

Connector Joining Wire Harness and Wire Harness

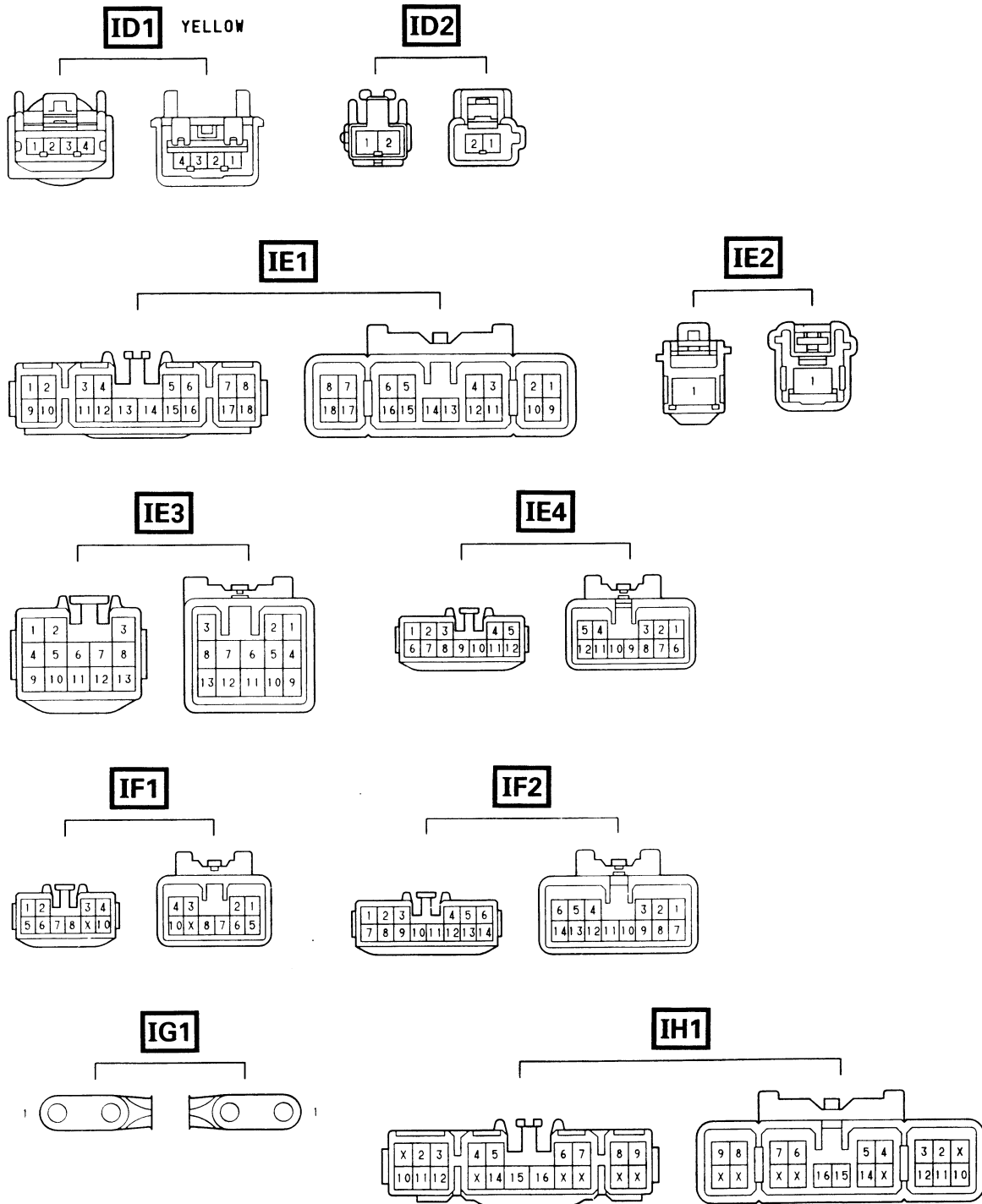

CODE	JOINING WIRE HARNESS AND WIRE HARNESS (CONNECTOR LOCATION)
ID1	COWL WIRE AND COWL WIRE (NEAR THE R/B NO.1)
ID2	COWL WIRE AND COWL WIRE (BEHIND COMBINATION METER)
IE1	ENGINE ROOM MAIN WIRE AND COWL WIRE (LEFT KICK PANEL)
IE2	
IE3	
IE4	
IF1	COWL WIRE AND FRONT DOOR LH WIRE (LEFT KICK PANEL)
IF2	FRONT DOOR LH WIRE AND COWL WIRE (LEFT KICK PANEL)
IG1	LUGGAGE ROOM WIRE AND ENGINE ROOM MAIN WIRE (BEHIND FOOTREST)
IH1	COWL WIRE AND A/C SUB WIRE (INSTRUMENT PANEL RIGHT)

G ELECTRICAL WIRING ROUTING

□ : Location of Connector Joining Wire Harness and Wire Harness

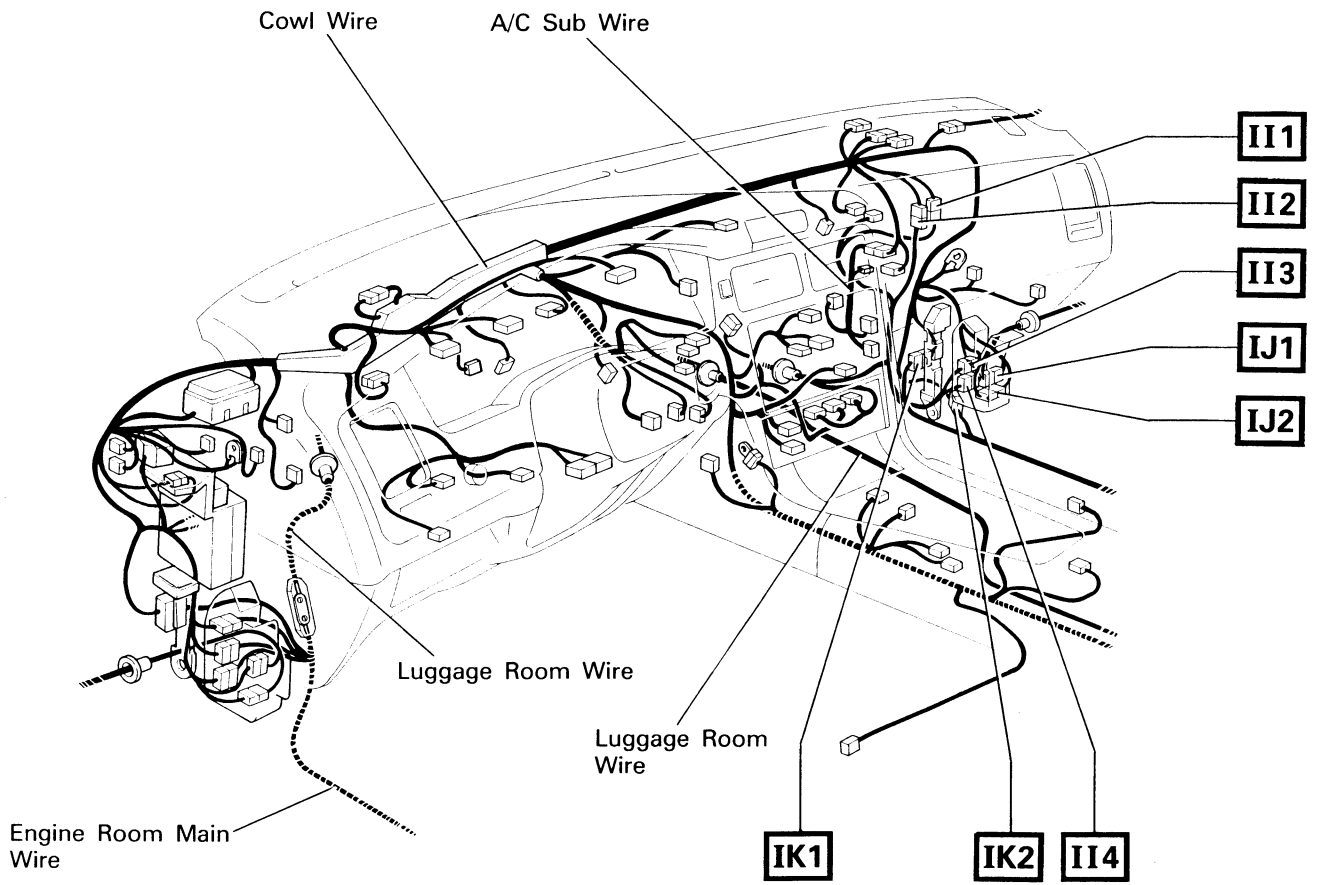

○ : Location of Splice Points

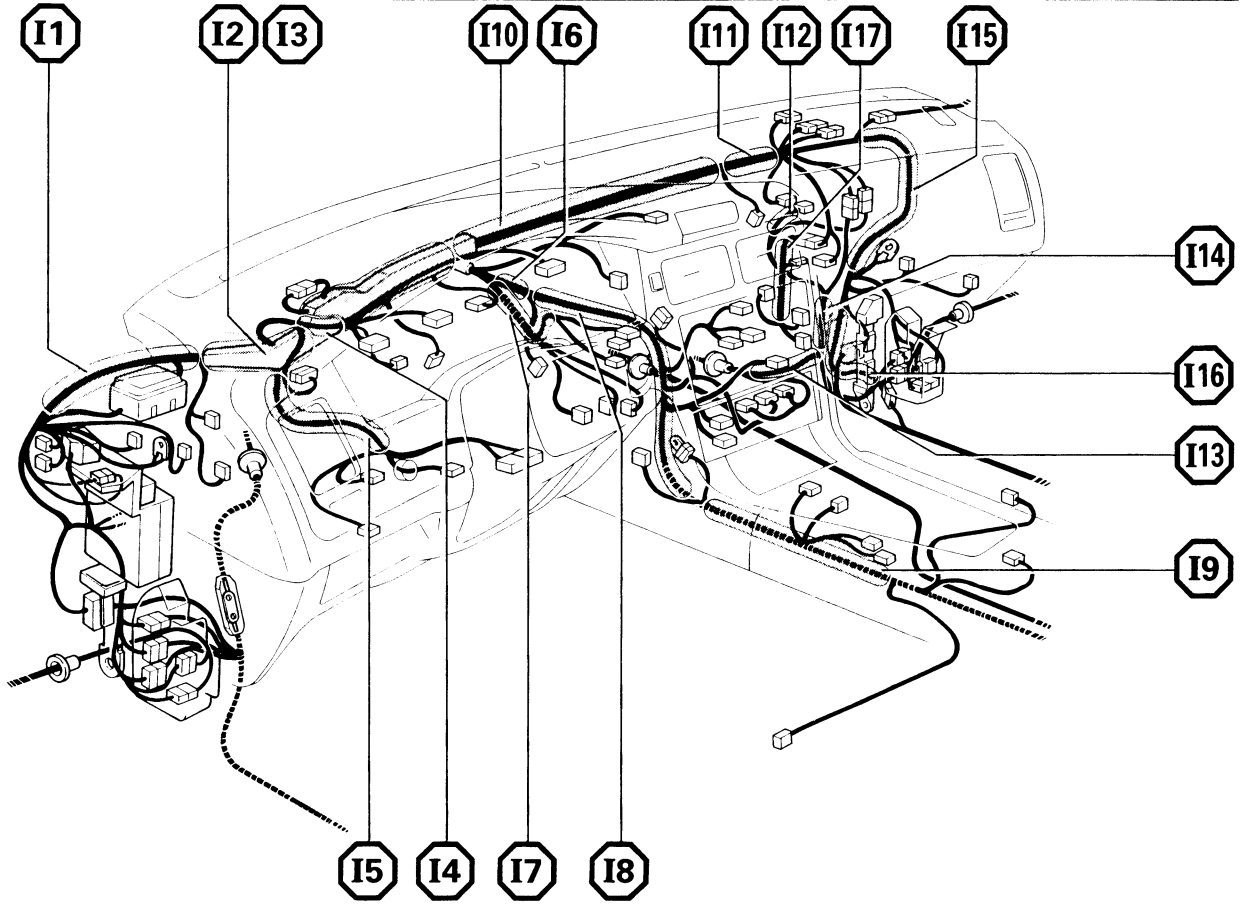

Connector Joining Wire Harness and Wire Harness

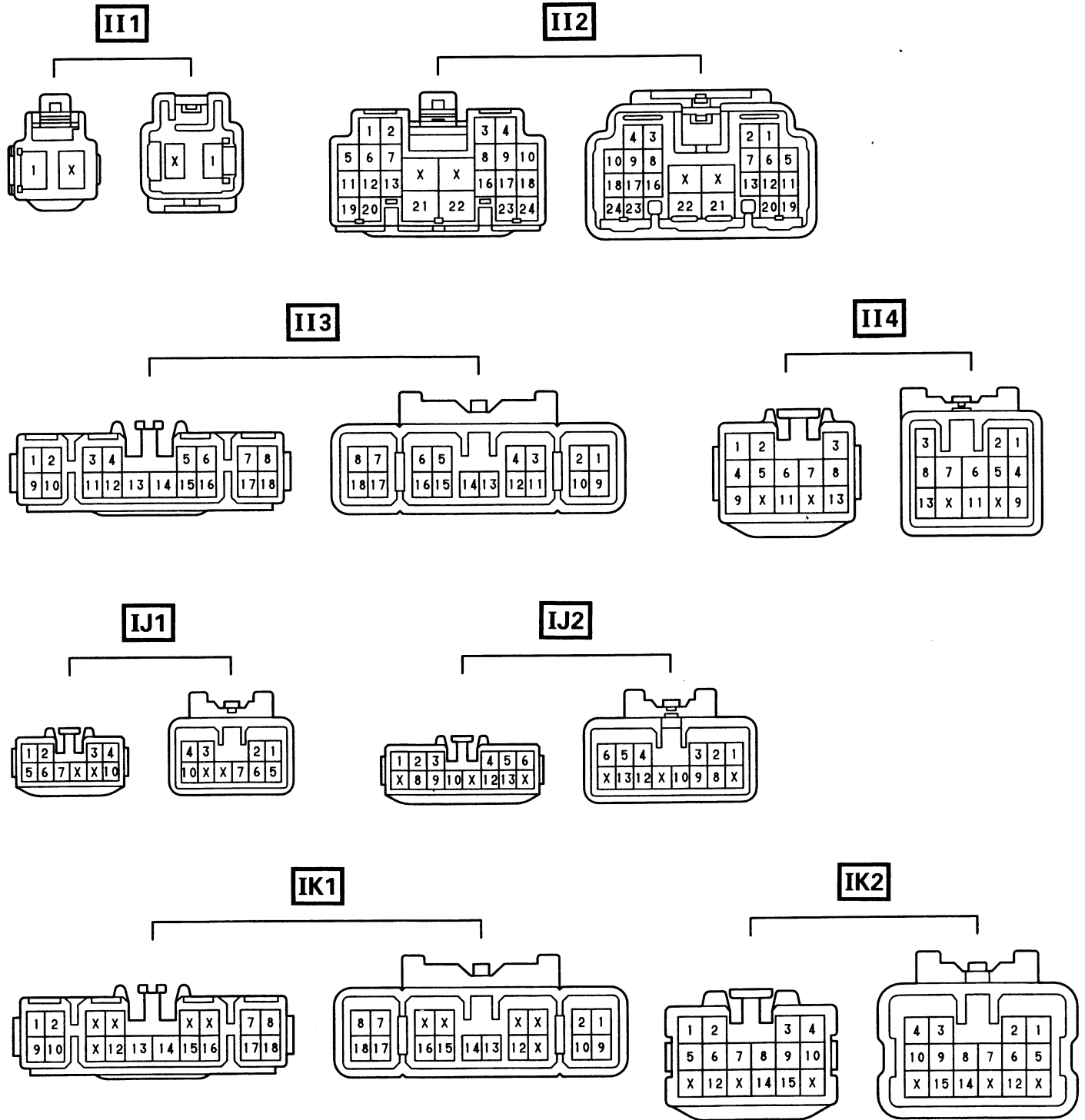

CODE	JOINING WIRE HARNESS AND WIRE HARNESS (CONNECTOR LOCATION)
II1	LUGGAGE ROOM WIRE AND COWL WIRE (RIGHT KICK PANEL)
II2	LUGGAGE ROOM WIRE AND COWL WIRE (RIGHT KICK PANEL)
II3	COWL WIRE AND LUGGAGE ROOM WIRE (RIGHT KICK PANEL)
II4	COWL WIRE AND LUGGAGE ROOM WIRE (RIGHT KICK PANEL)
IJ1	COWL WIRE AND FRONT DOOR RH WIRE (RIGHT KICK PANEL)
IJ2	FRONT DOOR RH WIRE AND COWL WIRE (RIGHT KICK PANEL)
IK1	FLOOR WIRE AND COWL WIRE (RIGHT KICK PANEL)
IK2	FLOOR WIRE AND COWL WIRE (RIGHT KICK PANEL)

G ELECTRICAL WIRING ROUTING

- : Location of Connector Joining Wire Harness and Wire Harness
- ▽ : Location of Ground Points

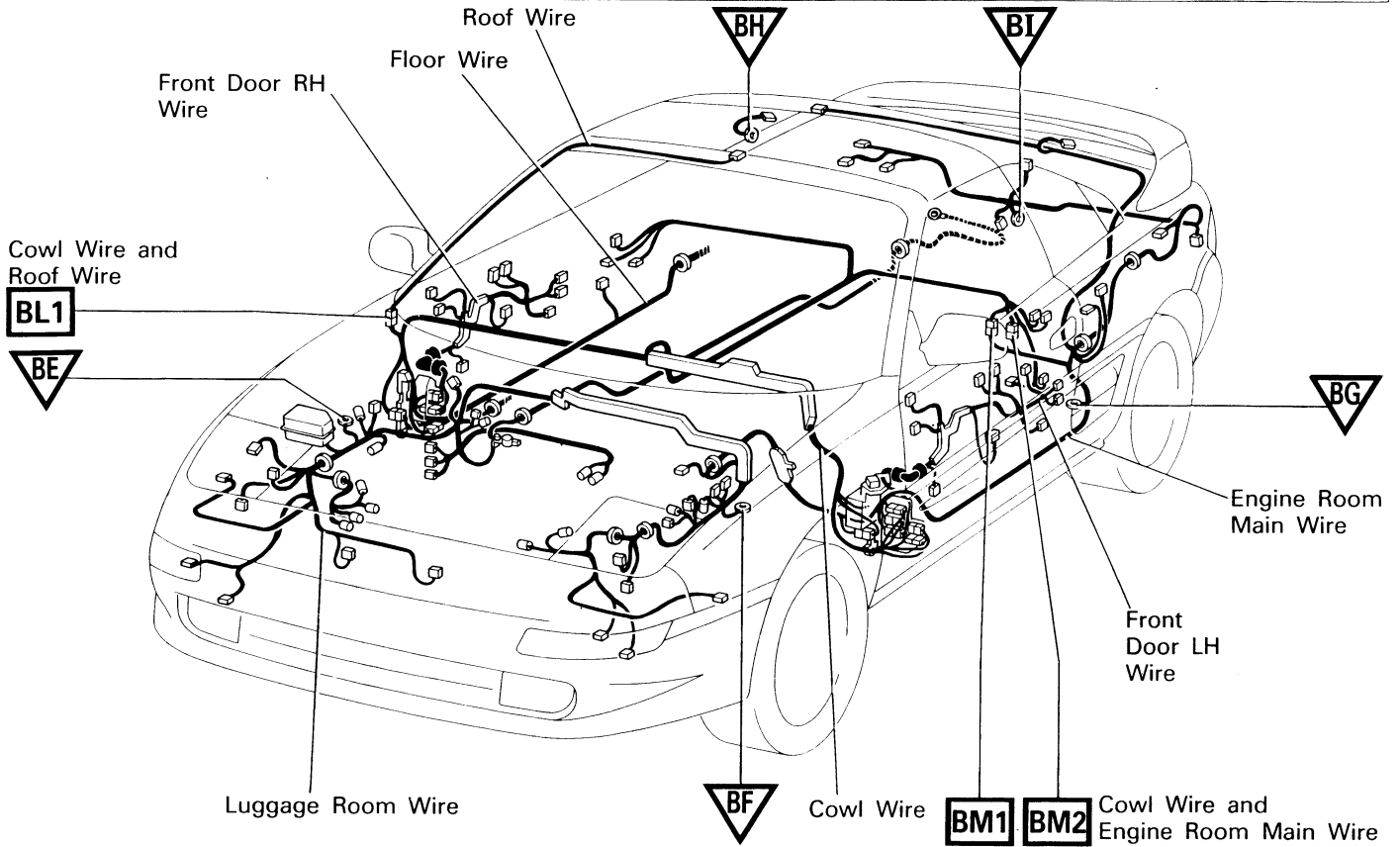

- : Location of Splice Points

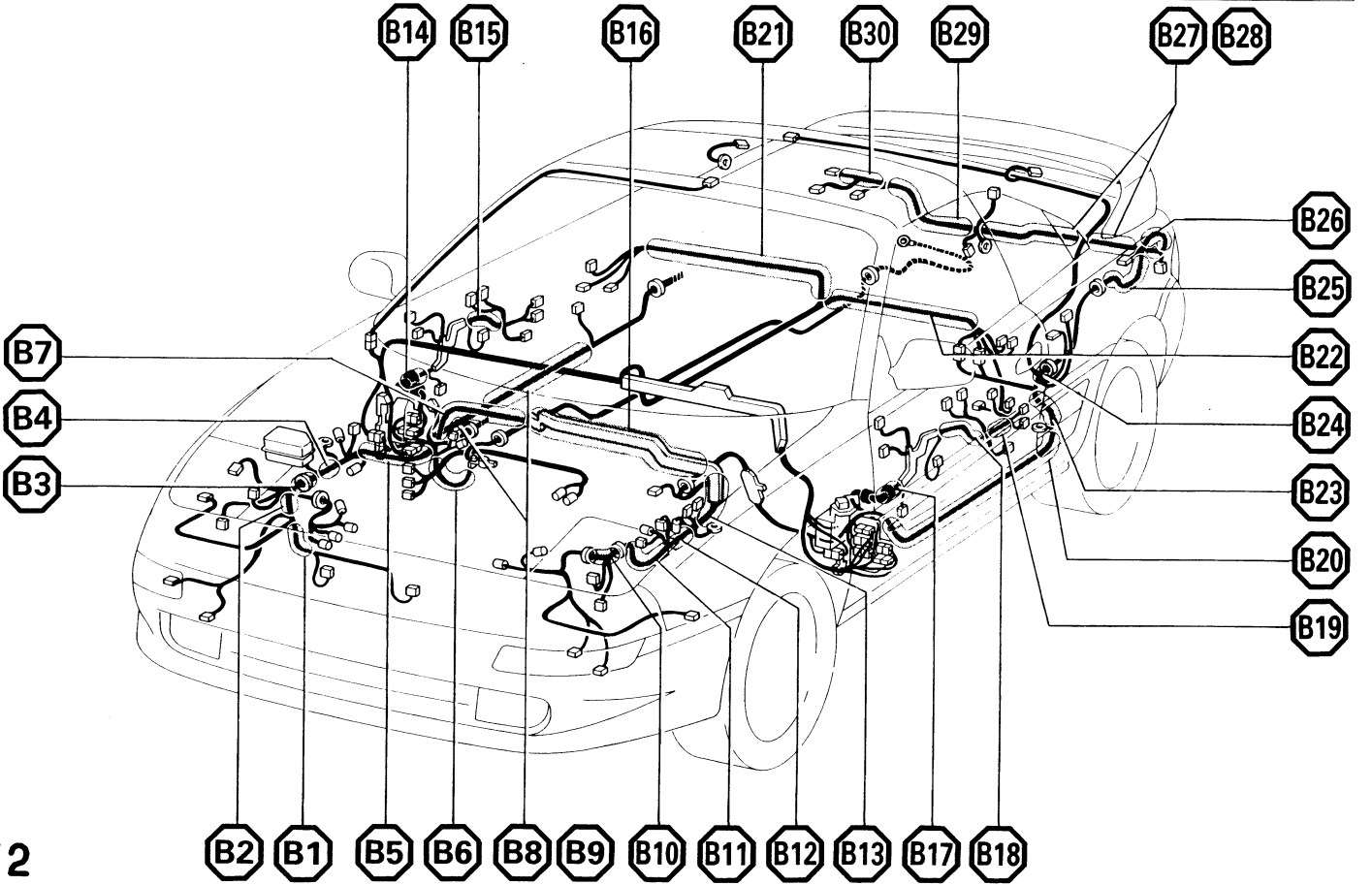

Connector Joining Wire Harness and Wire Harness

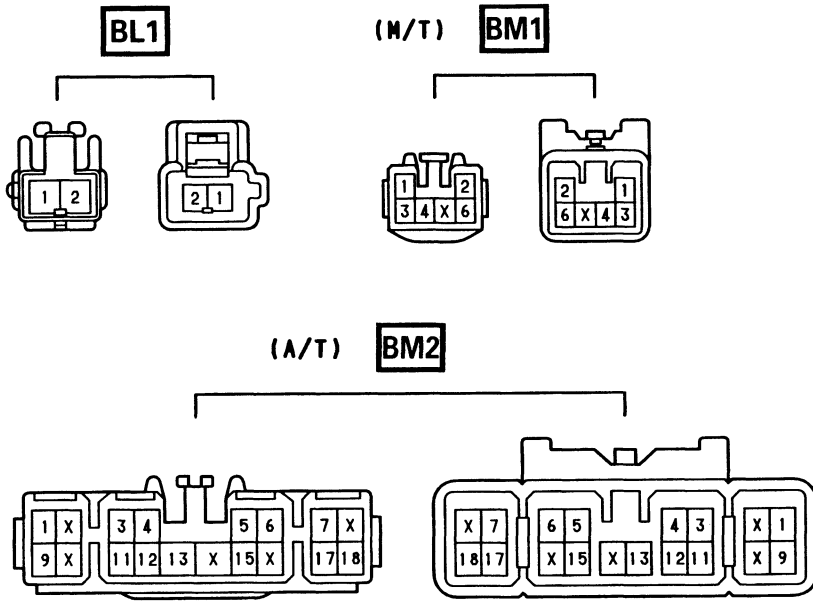

CODE	JOINING WIRE HARNESS AND WIRE HARNESS (CONNECTOR LOCATION)
BL1	ROOF WIRE AND COWL WIRE (UNDER THE RIGHT FRONT PILLAR)
BM1	ENGINE ROOM MAIN WIRE AND COWL WIRE (ROOM PARTITION BOARD LEFT)
BM2	COWL WIRE AND ENGINE ROOM MAIN WIRE (ROOM PARTITION BOARD LEFT)

H POWER SOURCE (Current Flow Chart)

The chart below shows the route by which current flows from the battery to each electrical source (Fusible Link, Circuit Breaker, Fuse, etc.) and other parts.

The next page and following pages show the parts to which each electrical source outputs current.

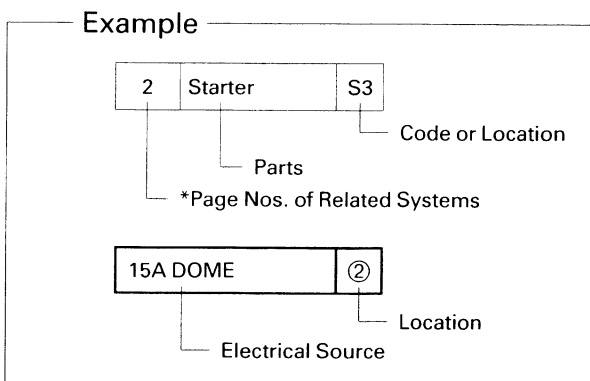
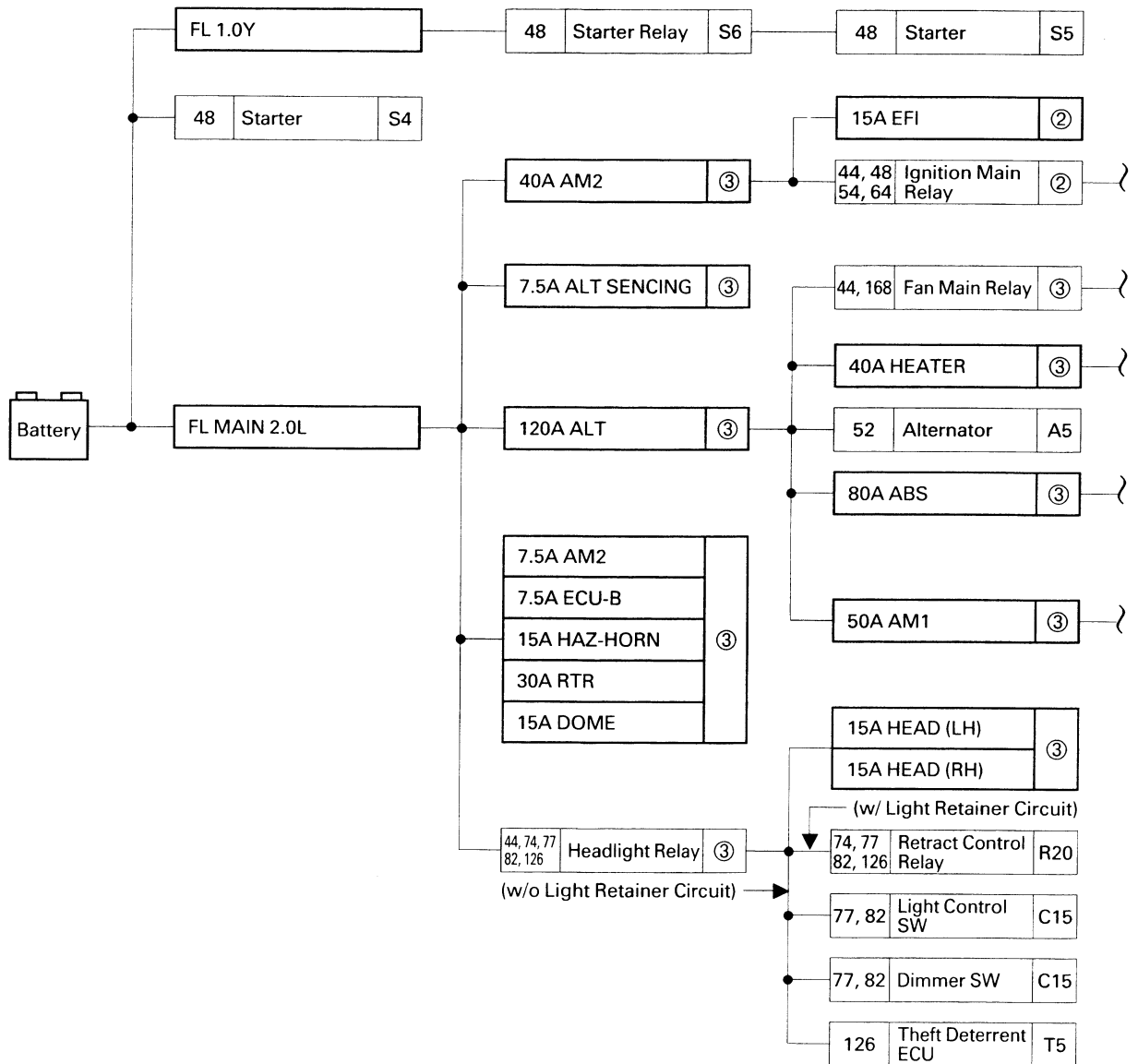

* These are the page numbers of the first page on which the related system is shown. The part indicated is located somewhere in the system, not necessarily on the page indicated here.

[LOCATION] ① : R/B No. 1 (See page 18) ② : R/B No. 2 (See page 18) ③ : R/B No. 5 (See page 17)

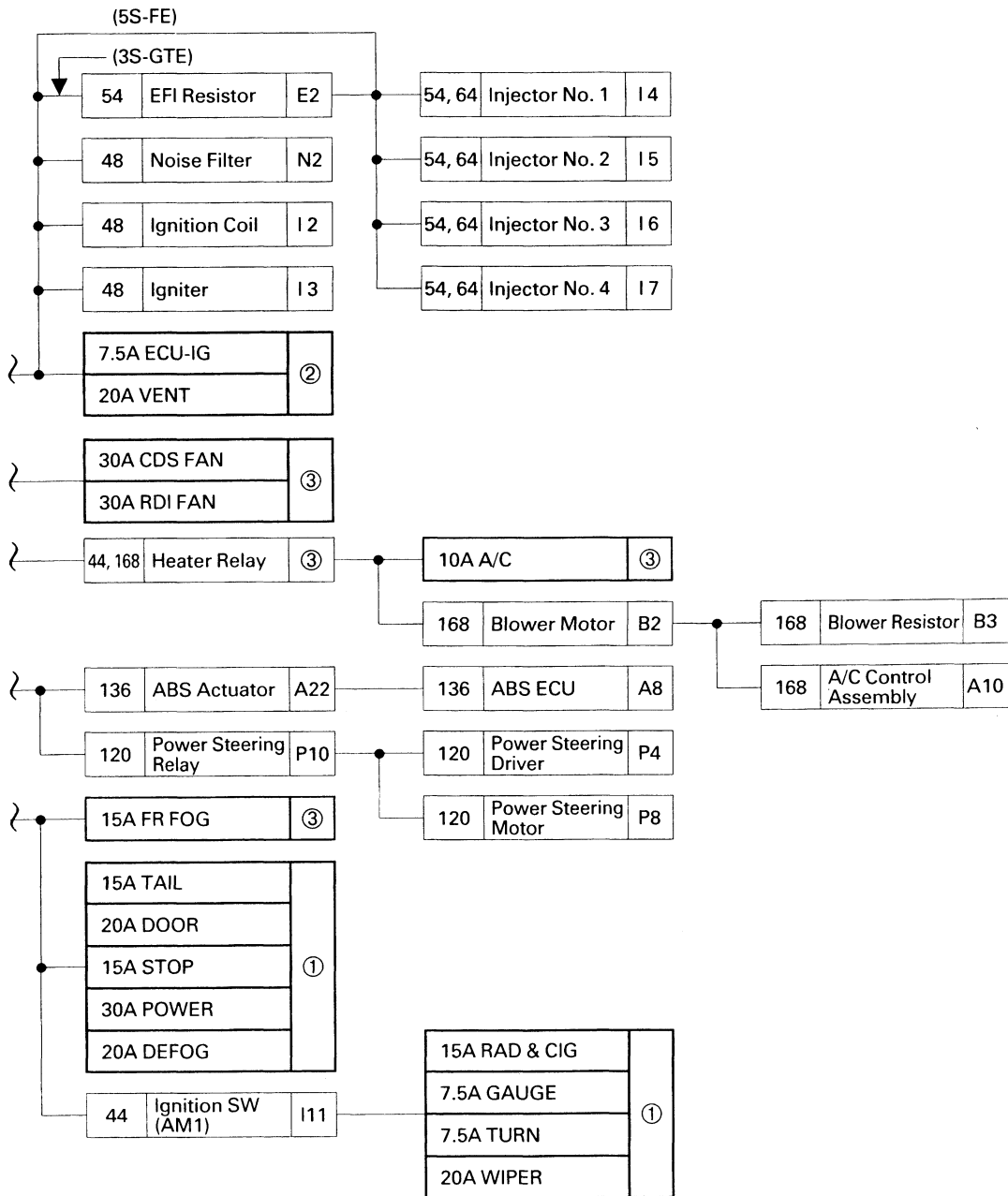

H POWER SOURCE (Current Flow Chart)

Location	* Page Nos. of Related Systems		Parts		Code or Location		CB or Fuse															
	168	52	136	168	89 168	132 168	89 168	168	89	136	168	154	96	162	54 64 113	48	72					
	A/C Magnet Clutch	Alternator	ABS ECU	A/C Amplifier	A/C Control Assembly			A/C Dual Pressure SW	A/C Magnet Clutch Relay	Air Inlet Servo Motor	Air Vent Mode Control Servo Motor	Ashtray Illumination	ABS Actuator	A/C Condenser Fan Motor	A/C High Pressure SW or Short Pin (w/o A/C)	Auto Antenna Control Relay and Motor	Back-Up Light SW (M/T)	Brake Fluid Level SW	Check Connector	Cold Start Injector	Cooling Fan ECU (for Engine Compartment)	
	A3	A5	A7	A8	A9	A10	A11	A12	A13	A15	A17	A18	A19	A21	A25	A26	A27	B1	B5	C1	C2	C3
①	15A	TAIL				●		●				●										
	15A	RAD & CIG														●						
	7.5A	GAUGE		●	●	●	●	●			●	●		●				●				●
	7.5A	TURN																				
	20A	WIPER																				
	20A	DEFOG																				
	15A	STOP		●																		
	20A	DOOR																				
	30A	POWER																				
	7.5A	MIR-HTR																				
②	15A	EFI																		●		
	20A	VENT																				●
	7.5A	ECU-IG		●		●										●	●					●
③	7.5A	ALT SENCING		●																		
	30A	CDS FAN												●								
	30A	RDI FAN																				
	15A	FR FOG																				
	15A	HEAD (LH)																				
	15A	HEAD (RH)																				
	10A	A/C	●			●			●	●	●											
	7.5A	ECU-B			●																●	
	7.5A	AM2		●		●									●						●	●
	15A	HAZ-HORN																				
	30A	RTR																				
	15A	DOME														●						

* These are the page numbers of the first page on which the related system is shown. The part indicated is located somewhere in the system, not necessarily on the page indicated here.

[LOCATION] ① : R/B No. 1 (See page 18) ② : R/B No. 2 (See page 18) ③ : R/B No. 5 (See page 17)

	72	152	89	152	48 54 64 126	113 162	72	92 162	136	54 64 162	162	89	146 162	141 162	120 162	107 162	94	52	77 82	141	120	110	77 80 82	119	80 86 89	94	146	113	132	
	C4	C6	C7	C8	C9	C10		C11									C12	C13	C14	C15			C17	C18	D2					
Cooling Fan Motor (for Engine Compartment)																														
Cigarette Lighter																														
Cigarette Lighter Illumination																														
Clock																														
Clutch Start SW (M/T)																														
Airbag Warning Light [Comb. Meter]																														
Cooling Fan Warning Light [Comb. Meter]																														
Door Warning Light [Comb. Meter]																														
ABS Warning Light [Comb. Meter]																														
Check Engine [Comb. Meter]																														
Combination Meter																														
Combination Meter (Illumination)																														
Cruise Control Indicator Light [Comb. Meter]																														
O/D Off Indicator Light [Comb. Meter]																														
Power Steering Warning Light [Comb. Meter]																														
Seat Belt Warning Light [Comb. Meter]																														
Turn Signal Indicator Lights [Comb. Meter]																														
Charge Warning Light [Comb. Meter]																														
High Beam Indicator Light [Comb. Meter]																														
A/T Indicator Light [Comb. Meter]																														
Steering Position Sensor [Comb. SW]																														
Wiper and Washer SW [Comb. SW]																														
Dimmer SW [Comb. SW]																														
Horn SW [Comb. SW]																														
Light Control SW [Comb. SW]																														
Turn Signal SW [Comb. SW]																														
Cruise Control ECU																														
Center Airbag Sensor Assembly																														
Diode (for Electrical Idle-Up System)																														

80		86			94	86	94	89 94	77 80 82	97	119	54 64 141	92	44, 48, 52 54, 64, 72 113, 126 152, 168	86	141	96	48 64 126	54	162	141	162	98	92		
Fog Light LH	Fog Light RH	Front Side Marker Light LH	Front Side Marker Light RH	Front Clearance Light LH	Front Turn Signal Light LH	Front Clearance Light RH	Front Turn Signal Light RH	Hazard SW	Headlight LH	Headlight RH	High Mount Stop Light	Horn	ISC Valve	Interior Light Control Relay	Ignition Key Cylinder Light	Ignition SW (AM2)	Licence Plate Light	A/T Indicator SW	Back-Up Light SW (A/T)	Neutral Start SW	Oxygen Sensor (Main)	Oil Pressure SW	O/D Main SW	Parking Brake SW	Power Main Relay	Personal Light
F6	F7	F11	F12	F13	F14	H1	H2	H3	H4	H5	H6	I1	I9	I10	I11	L1	N1	O1	O3	O4	P1	P2	P3			
		●	●	●		●										●										
					●														●		●					
						●																				
									●																	
												●							●							
																	●	●								
●	●																									
							●																			
								●																		
					●										●											
						●														●						
														●												
																										●

H POWER SOURCE (Current Flow Chart)

Location	* Page Nos. of Related Systems		120		98				89	89 160	89	168	96	94	97	86	96	94	97	86	92	132	156 160	
	Parts		Power Steering Driver	Power Steering ECU	Power Window SW RH	Power Window Master SW and Door Lock Control SW	Power Window Motor LH	Power Window Motor RH	Radio and Player (w/ CD Player)	Radio and Player (w/o CD Player)	Rheostat	Radiator Fan Motor	Back-Up Light LH (Rear Comb. Light LH)	Rear Turn Signal Light LH (Rear Comb. Light LH)	Stop Light LH (Rear Comb. Light LH)	Tail and Rear Side Marker Light LH (Rear Comb. Light LH)	Back-Up Light RH (Rear Comb. Light RH)	Rear Turn Signal Light RH (Rear Comb. Light RH)	Stop Light RH (Rear Comb. Light RH)	Tail and Rear Side Marker Light RH (Rear Comb. Light RH)	Rear Luggage Compartment Door Courtesy SW	Rear Luggage Compartment Light	Rear Window Defogger	Rear Woofer Amplifier
	Code or Location		CB or Fuse	P6	P7	P12	P13	P14	P15	R1	R2	R4	R5	R6			R7			R8	R10	R13	R15	
①	15A	TAIL							●	●	●				●				●					
	15A	RAD & CIG								●														
	7.5A	GAUGE	●	●																				
	7.5A	TURN											●					●						
	20A	WIPER																						
	20A	DEFOG																					●	
	15A	STOP												●				●						
	20A	DOOR																						
	30A	POWER			●	●	●	●																
	7.5A	MIR-HTR																						
②	15A	EFI																						
	20A	VENT																						
	7.5A	ECU-IG										●				●								
③	7.5A	ALT SENCING																						
	30A	CDS FAN										●												
	30A	RDI FAN										●												
	15A	FR FOG																						
	15A	HEAD (LH)																						
	15A	HEAD (RH)																						
	10A	A/C																						
	7.5A	ECU-B																						
	7.5A	AM2																						
	15A	HAZ-HORN												●				●						
	30A	RTR																						
	15A	DOME								●											●	●	●	

* These are the page numbers of the first page on which the related system is shown. The part indicated is located somewhere in the system, not necessarily on the page indicated here.

[LOCATION] ① : R/B No. 1 (See page 18) ② : R/B No. 2 (See page 18) ③ : R/B No. 5 (See page 17)

124			74, 77, 80 82, 86, 89 126	82 89 86	77 82	146	48	48 126	134	107	54, 64, 97 134, 136 141, 146	156	126	94	126	54 64	168	64	54	162	110	168	110			
Remote Control Mirror LH	Remote Control Mirror RH	Remote Control Mirror SW	Retract Control Relay	Retract Control Relay (Canada)	Retract Motor LH	Retract Motor RH	Speed Sensor (for Cruise Control System)	Start Injector Time SW	Starter Relay	Shift Lock ECU	Seat Belt Warning Relay	Stop Light SW	Stereo Component Amplifier	Theft Deterrent Horn	Turn Signal Flasher	Theft Deterrent ECU	VSV (for EGR System)	VSV (for A/C Idle-Up System)	VSV (for Fuel Pressure Up Control System)	VSV (for Turbo Pressure Control System)	VSV (for T-VIS)	Water Temp. Sender	Washer Motor	Water Temp. Sensor (for Radiator Fan)	Wiper Motor	
R17	R18	R19	R20	R21	R22	R23	S1	S3	S6	S7	S8	S9	S10	S11	T1	T4	T5	V2	V3	V4	V5	V6	W1	W2	W3	W4
•	•	•	•	•						•				•		•										
			•	•							•					•										
												•												•		
																										•
							•											•								
																					•					
			•	•																						
			•					•																		
									•																	

H POWER SOURCE (Current Flow Chart)

Location	CB or Fuse	* Page Nos. of Related Systems		Defogger Relay	Taillight Relay	Circuit Opening Relay	Cooling Fan Relay (for Engine Compartment)	EFI Main Relay	Ignition Main Relay	Fan Main Relay	Fan Relay No. 1	Fan Relay No. 2	Fan Relay No. 3	Front Fog Light Relay	Heater Relay	Horn Relay		
		132	44, 74, 82 86, 89, 126 152														54 64	72
		Parts		Code or Location		CB or Fuse												
				①		②						③						
①	15A	TAIL		●														
	15A	RAD & CIG																
	7.5A	GAUGE	●													●		
	7.5A	TURN																
	20A	WIPER																
	20A	DEFOG	●															
	15A	STOP																
	20A	DOOR																
	30A	POWER																
	7.5A	MIR-HTR																
②	15A	EFI			●		●											
	20A	VENT				●												
	7.5A	ECU-IG																
③	7.5A	ALT SENCING																
	30A	CDS FAN									●	●						
	30A	RDI FAN								●								
	15A	FR FOG												●				
	15A	HEAD (LH)												●				
	15A	HEAD (RH)												●				
	10A	A/C																
	7.5A	ECU-B																
	7.5A	AM2			●	●	●	●	●	●	●	●						
	15A	HAZ-HORN															●	
	30A	RTR																
	15A	DOMES																

* These are the page numbers of the first page on which the related system is shown. The part indicated is located somewhere in the system, not necessarily on the page indicated here.

[LOCATION] ① : R/B No. 1 (See page 18) ② : R/B No. 2 (See page 18) ③ : R/B No. 5 (See page 17)

1991 TOYOTA MR2 ELECTRICAL WIRING DIAGRAM SYSTEM CIRCUITS

	Page
ABS	136
AUTO ANTENNA	154
BACK-UP LIGHT	96
CHARGING	52
CIGARETTE LIGHTER AND CLOCK	152
COMBINATION METER	162
CRUISE CONTROL	146
DOOR LOCK	102
ECT AND A/T INDICATOR LIGHT	141
EHPS (ELECTRO-HYDRAULIC POWER STEERING)	120
ENGINE CONTROL	54
ENGINE COMPARTMENT COOLING FAN	72
FOG LIGHT (USA)	80
HEADLIGHT (USA)	77
HEADLIGHT AND FOG LIGHT (CANADA)	82
HORN	119
ILLUMINATION	89
INTERIOR LIGHT	92
LIGHT AUTO TURN OFF	74
POWER SOURCE	44
POWER WINDOW	98
RADIATOR FAN AND AIR CONDITIONER	168
RADIO AND PLAYER	156
REAR WINDOW DEFOGGER	132
REMOTE CONTROL MIRROR	124
SHIFT LOCK	134
SRS AIRBAG	113
STARTING AND IGNITION	48
STOP LIGHT	97
TAILLIGHT	86
THEFT DETERRENT	126
TURN SIGNAL AND HAZARD WARNING LIGHT	94
UNLOCK AND SEAT BELT WARNING	107
WIPER AND WASHER	110



POWER SOURCE

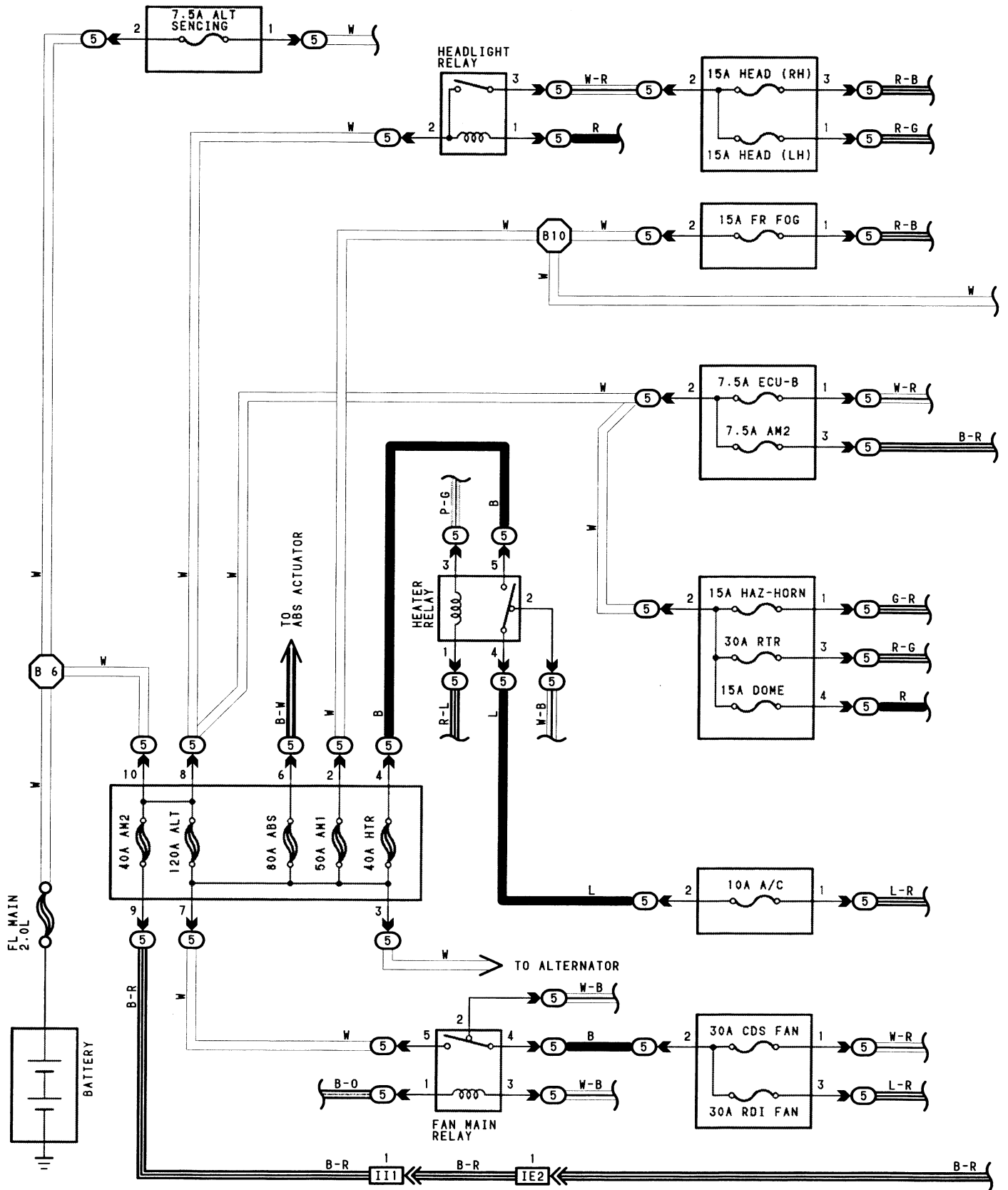

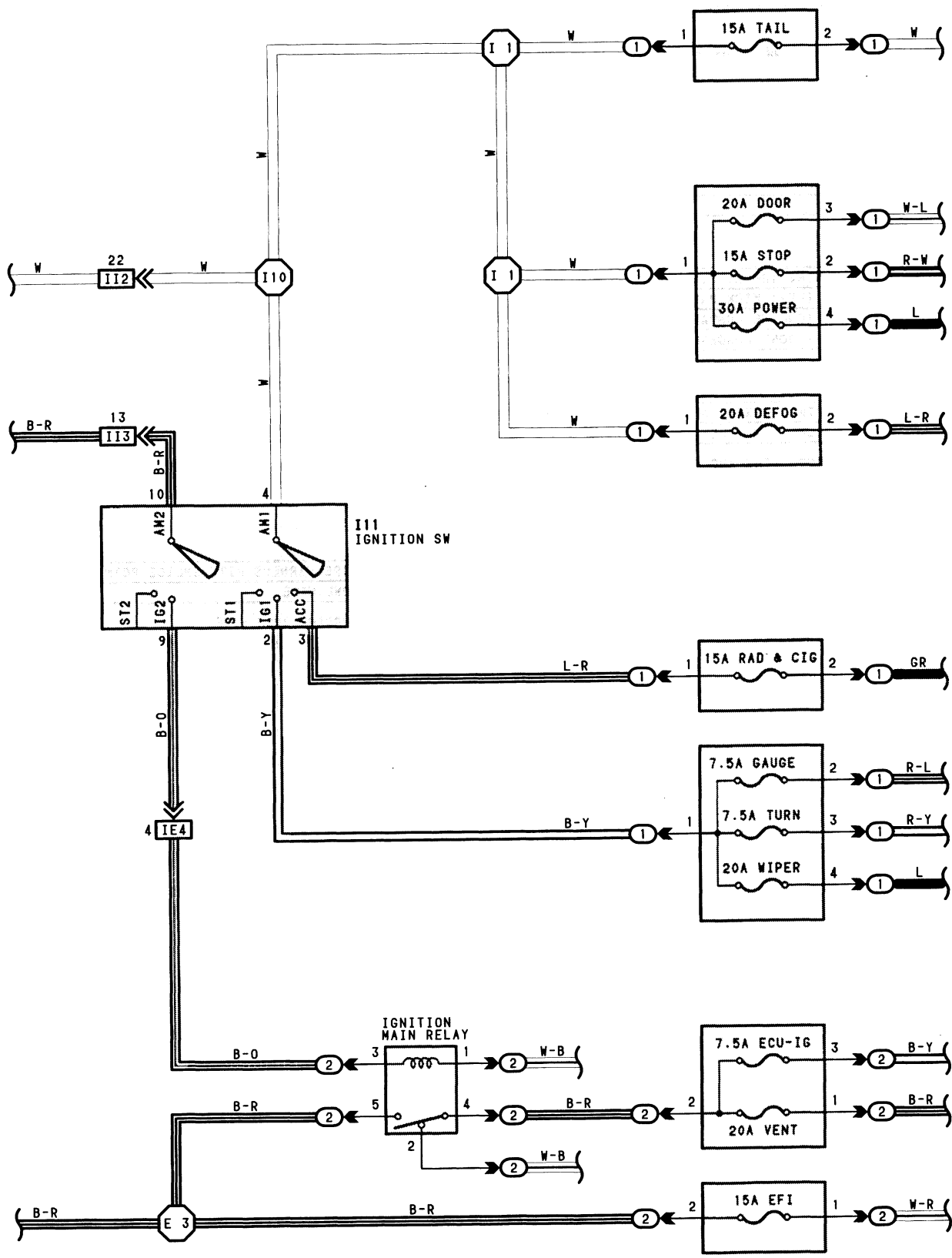



POWER SOURCE

SERVICE HINTS

HEADLIGHT RELAY

2-3:CLOSED WITH LIGHT CONTROL SW AT HEAD POSITION OR DIMMER SW AT FLASH POSITION

IGNITION MAIN RELAY

5-4:CLOSED WITH IGNITION SW AT ON OR ST POSITION

FAN MAIN RELAY

4-5:CLOSED WITH IGNITION SW AT ON OR ST POSITION

○ : PARTS LOCATION

CODE	SEE PAGE	CODE	SEE PAGE	CODE	SEE PAGE
I11	22				

○ : RELAY BLOCKS

CODE	SEE PAGE	RELAY BLOCKS (RELAY BLOCK LOCATION)
1	18	R/B NO.1 (LEFT KICK PANEL)
2	18	R/B NO.2 (ENGINE COMPARTMENT LEFT)
5	17	R/B NO.5 (FRONT LUGGAGE COMPARTMENT RIGHT)

□ : CONNECTOR JOINING WIRE HARNESS AND WIRE HARNESS

CODE	SEE PAGE	JOINING WIRE HARNESS AND WIRE HARNESS (CONNECTOR LOCATION)
IE4	28	ENGINE ROOM MAIN WIRE AND COWL WIRE (LEFT KICK PANEL)
I11	30	LUGGAGE ROOM WIRE AND COWL WIRE (RIGHT KICK PANEL)
I12		
I13	30	COWL WIRE AND LUGGAGE ROOM WIRE (RIGHT KICK PANEL)

○ : SPLICE POINTS

CODE	SEE PAGE	WIRE HARNESS WITH SPLICE POINTS	CODE	SEE PAGE	WIRE HARNESS WITH SPLICE POINTS
E 3	24(5S-FE)	ENGINE ROOM MAIN WIRE	I10	30	COWL WIRE
	26(3S-6TE)		B 6	32	LUGGAGE ROOM WIRE
I 1	30	COWL WIRE	B10		

I11 BLACK

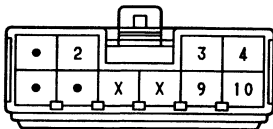



STARTING AND IGNITION

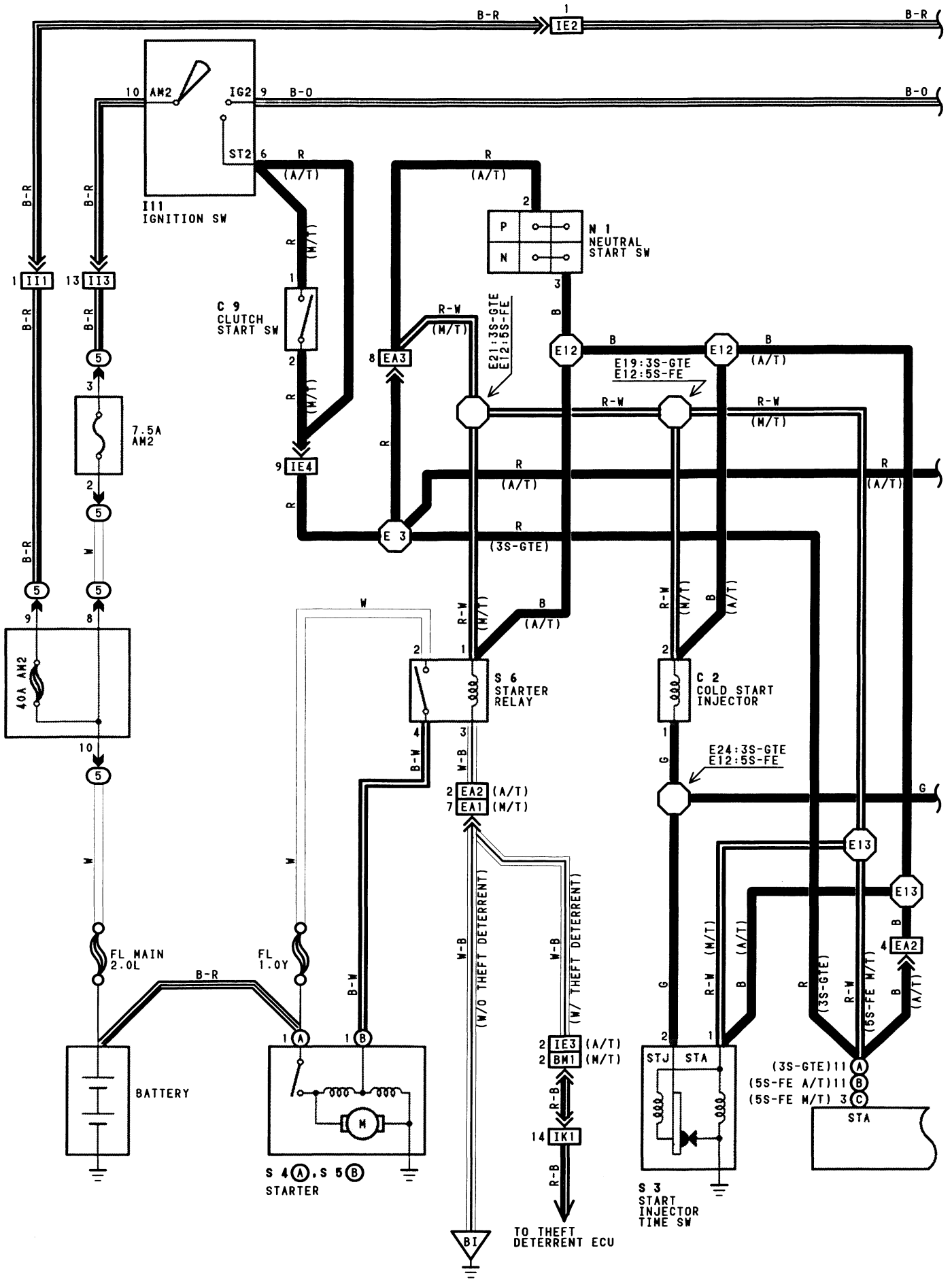

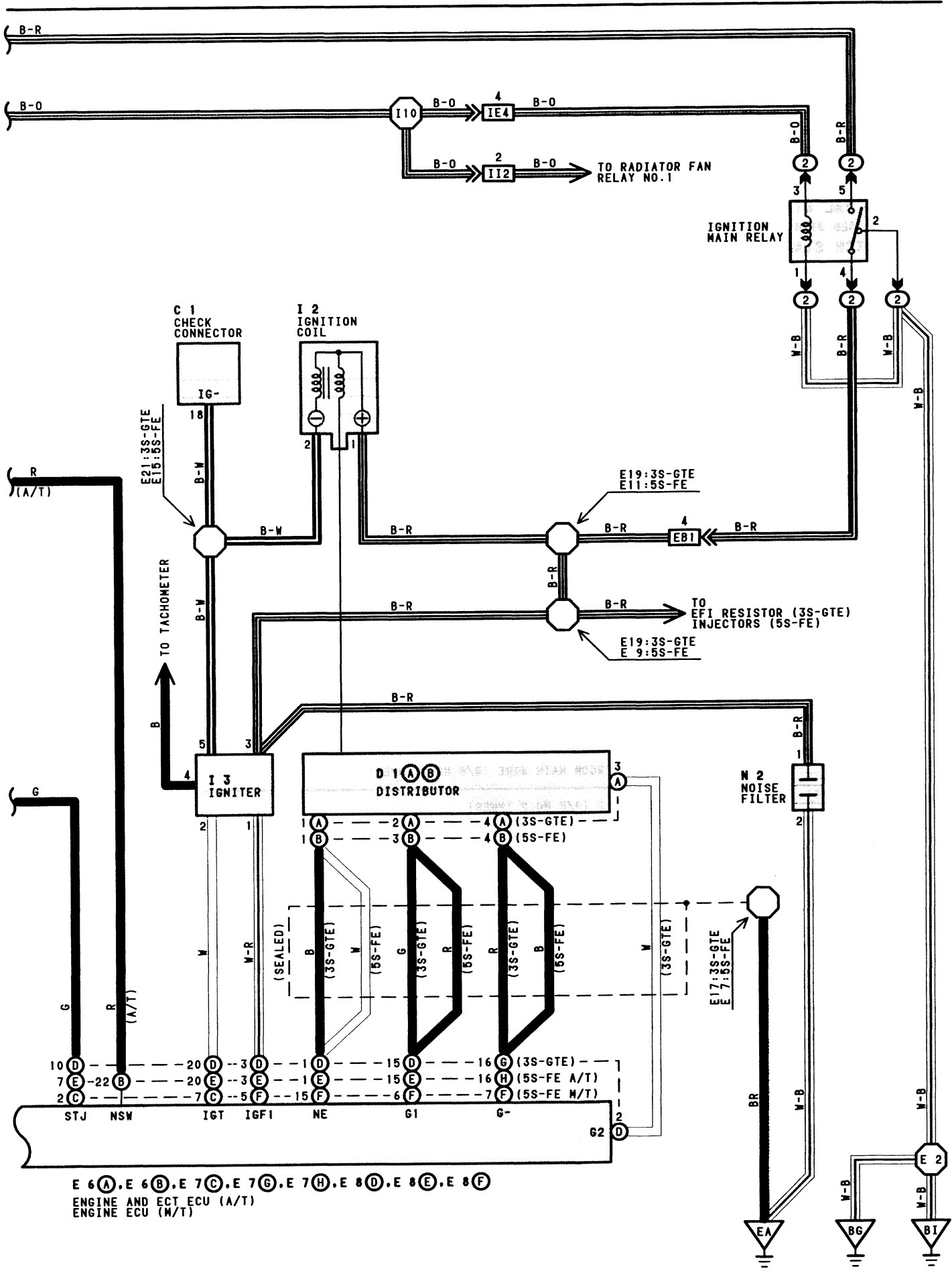



STARTING AND IGNITION

SERVICE HINTS

IGNITION MAIN RELAY

② 1- ② 2: CLOSED WITH IGNITION SW AT ON POSITION

I11 IGNITION SW

10-9: CLOSED WITH IGNITION SW AT ON OR ST POSITION
10-6: CLOSED WITH IGNITION SW AT ST POSITION

S 6 STARTER RELAY

2-4: CLOSED WITH A/T SHIFT LEVER IN P OR N POSITION AND IGNITION SW AT ST POSITION (A/T)
2-4: CLOSED WITH CLUTCH START SW ON POSITION AND IGNITION SW AT ST POSITION (M/T)

N 1 NEUTRAL START SW (A/T)

2-3: CLOSED WITH A/T SHIFT LEVER IN P OR N POSITION

C 9 CLUTCH START SW (M/T)

1-2: CLOSED WITH CLUTCH PEDAL FULLY DEPRESSED

C 2 COLD START INJECTOR

1-2: APPROX. 12VOLTS WITH WHILE START INJECTOR TIME SW IS CLOSED AND STARTER CRANKING

○ : PARTS LOCATION

CODE	SEE PAGE	CODE	SEE PAGE	CODE	SEE PAGE
C 1	20(5S-FE), 21(3S-GTE)	E 7	G 21(3S-GTE)	N 1	20(5S-FE)
C 2	20(5S-FE), 21(3S-GTE)		H 20(5S-FE)	N 2	20(5S-FE), 21(3S-GTE)
C 9	22	E 8	D 21(3S-GTE)	S 3	20(5S-FE), 21(3S-GTE)
D 1	A 21(3S-GTE)		E 20(5S-FE)	S 4	A 20(5S-FE), 21(3S-GTE)
	B 20(5S-FE)		F 20(5S-FE)	S 5	B 20(5S-FE), 21(3S-GTE)
E 6	A 21(3S-GTE)	I 2	20(5S-FE), 21(3S-GTE)	S 6	20(5S-FE), 21(3S-GTE)
	B 20(5S-FE)	I 3	20(5S-FE), 21(3S-GTE)		
E 7	C 20(5S-FE)	I11	22		

○ : RELAY BLOCKS

CODE	SEE PAGE	RELAY BLOCKS (RELAY BLOCK LOCATION)
2	18	R/B NO.2 (ENGINE COMPARTMENT LEFT)
5	17	R/B NO.5 (FRONT LUGGAGE COMPARTMENT RIGHT)

□ : CONNECTOR JOINING WIRE HARNESS AND WIRE HARNESS

CODE	SEE PAGE	JOINING WIRE HARNESS AND WIRE HARNESS (CONNECTOR LOCATION)
EA1	24(5S-FE)	ENGINE WIRE AND ENGINE ROOM MAIN WIRE (REAR LUGGAGE COMPARTMENT LEFT)
	26(3S-GTE)	
EA2	24(5S-FE)	
EA3	24(5S-FE)	ENGINE WIRE AND ENGINE ROOM MAIN WIRE (R/B NO.2 INNER)
	26(3S-GTE)	
EB1	24(5S-FE)	ENGINE WIRE AND R/B NO.2 (R/B NO.2 INNER)
	26(3S-GTE)	
IE2	28	ENGINE ROOM MAIN WIRE AND COWL WIRE (LEFT KICK PANEL)
IE3		
IE4		
I11	30	LUGGAGE ROOM WIRE AND COWL WIRE (RIGHT KICK PANEL)
I12		
I13	30	COWL WIRE AND LUGGAGE ROOM WIRE (RIGHT KICK PANEL)
IK1	30	FLOOR WIRE AND COWL WIRE (RIGHT KICK PANEL)
BM1	32	ENGINE ROOM MAIN WIRE AND COWL WIRE (ROOM PARTITION BOARD LEFT)

▽ : GROUND POINTS

CODE	SEE PAGE	GROUND POINTS LOCATION
EA	24(5S-FE)	INTAKE MANIFOLD
	26(3S-GTE)	
B6	32	UNDER THE LEFT CENTER PILLAR
BI	32	BACK PANEL CENTER

○ : SPLICE POINTS

CODE	SEE PAGE	WIRE HARNESS WITH SPLICE POINTS	CODE	SEE PAGE	WIRE HARNESS WITH SPLICE POINTS
E 2	24(5S-FE)	ENGINE ROOM MAIN WIRE	E13	24(5S-FE)	ENGINE WIRE
	26(3S-GTE)		E15		
E 3	24(5S-FE)		E17	26(3S-GTE)	
	26(3S-GTE)		E19		
E 7	24(5S-FE)	ENGINE WIRE	E21	30	COWL WIRE
E 9			E24		
E11			I10		
E12					

C 1 DARK GRAY

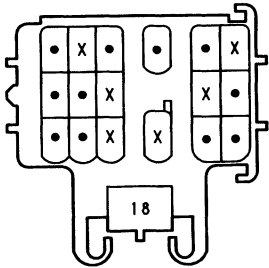

C 2 BLACK

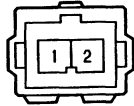

C 9

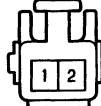

D 1 (A) BLACK



D 1 (B) BLACK

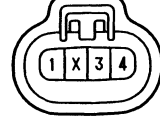

E 6 (A) DARK GRAY

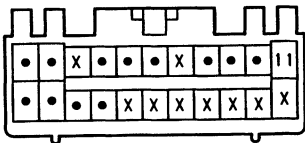

E 6 (B) DARK GRAY

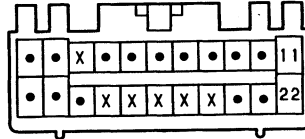

E 7 (C) DARK GRAY

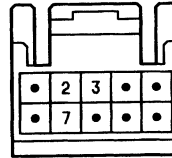

E 7 (G) DARK GRAY

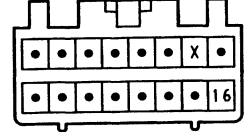

E 7 (H) DARK GRAY

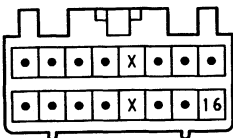

E 8 (D) DARK GRAY

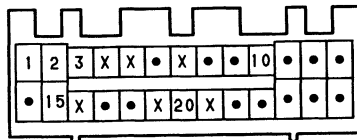

E 8 (E) DARK GRAY

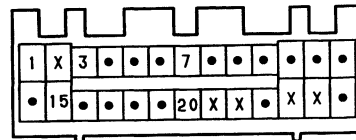

E 8 (F) DARK GRAY

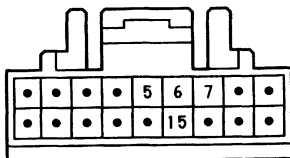

I 2 BLACK



I 3 BLACK

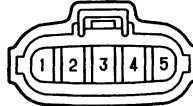

I11 BLACK

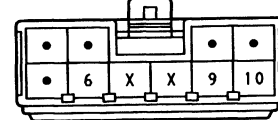

N 1 GRAY

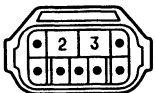

N 2 GRAY



(3S-GTE) S 3 BLACK



(5S-FE) S 3 GRAY



S 4 (A)

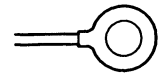

S 5 (B) BROWN



S 6

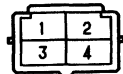



CHARGING

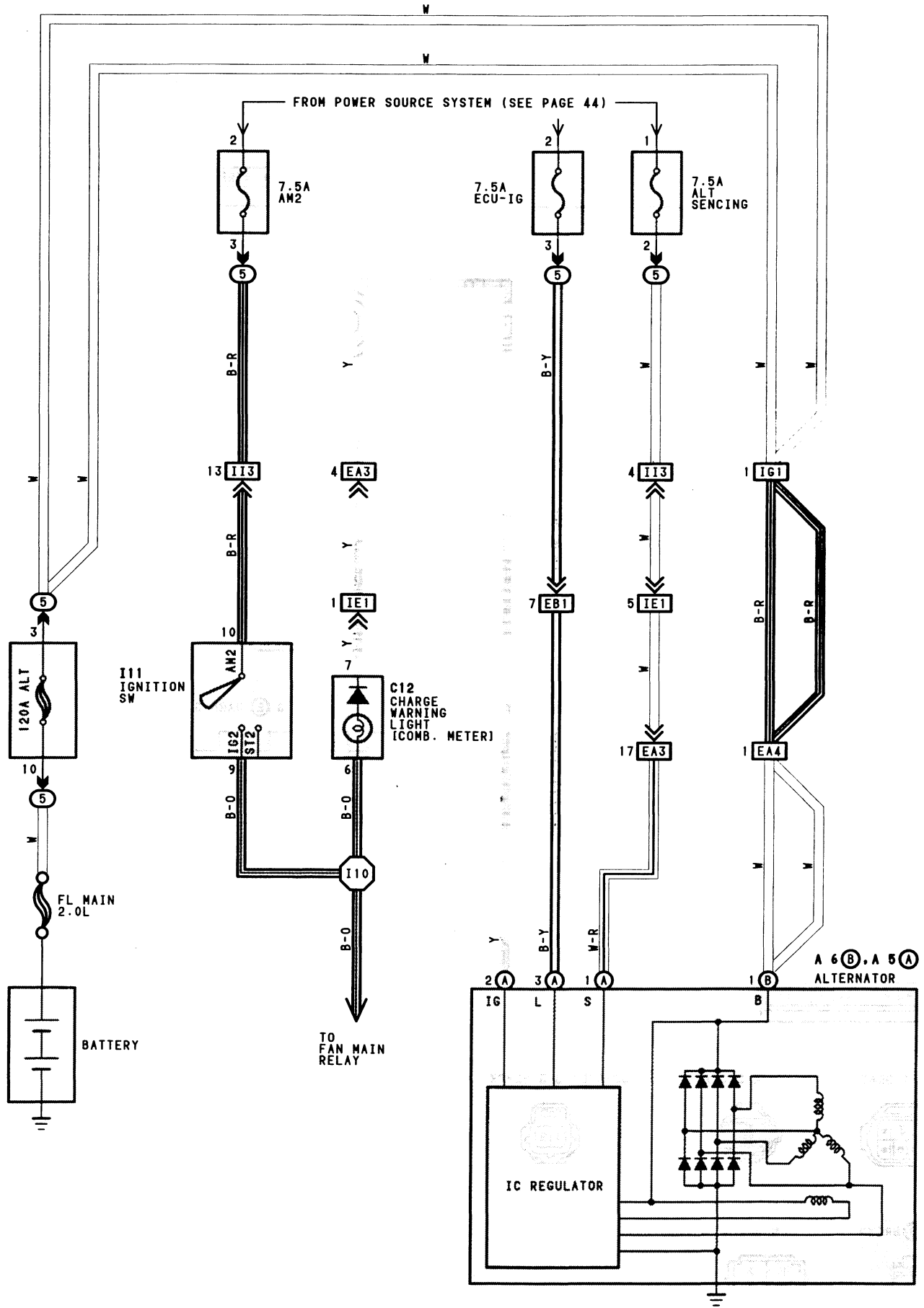

SERVICE HINTS

A 5 Ⓐ ALTERNATOR

- Ⓐ 1-GROUND: 13.9-15.1VOLTS WITH ENGINE RUNNING AT 2000 RPM AND 25°C(77°F)
13.5-14.3VOLTS WITH ENGINE RUNNING AT 2000 RPM AND 115°C(239°F)
- Ⓐ 2-GROUND: 0-4VOLTS WITH IGNITION SW AT ON POSITION AND ENGINE NOT RUNNING

○ : PARTS LOCATION

CODE	SEE PAGE	CODE	SEE PAGE	CODE	SEE PAGE
A 5	B	20(5S-FE), 21(3S-GTE)	C12	22	
A 6	A	20(5S-FE), 21(3S-GTE)	I11	22	

○ : RELAY BLOCKS

CODE	SEE PAGE	RELAY BLOCKS (RELAY BLOCK LOCATION)
5	17	R/B NO.5 (FRONT LUGGAGE COMPARTMENT RIGHT)

□ : CONNECTOR JOINING WIRE HARNESS AND WIRE HARNESS

CODE	SEE PAGE	JOINING WIRE HARNESS AND WIRE HARNESS (CONNECTOR LOCATION)
EA3	24(5S-FE)	ENGINE WIRE AND ENGINE ROOM MAIN WIRE (R/B NO.2 INNER)
	26(3S-GTE)	
EA4	24(5S-FE)	ENGINE WIRE AND R/B NO.2 (R/B NO.2 INNER)
	26(3S-GTE)	
EB1	24(5S-FE)	ENGINE ROOM MAIN WIRE AND COWL WIRE (LEFT KICK PANEL)
	26(3S-GTE)	
IE1	28	LUGGAGE ROOM WIRE AND ENGINE ROOM MAIN WIRE (BEHIND FOOTREST)
I13	30	COWL WIRE AND LUGGAGE ROOM WIRE (RIGHT KICK PANEL)

○ : SPLICE POINTS

CODE	SEE PAGE	WIRE HARNESS WITH SPLICE POINTS	CODE	SEE PAGE	WIRE HARNESS WITH SPLICE POINTS
I10	30	COWL WIRE			

A 5 Ⓐ BLACK

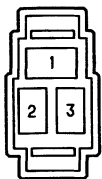

A 6 Ⓑ



C12 GRAY

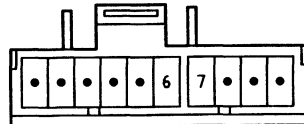

I11 GRAY

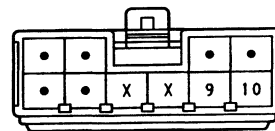



ENGINE CONTROL (3S-GTE)

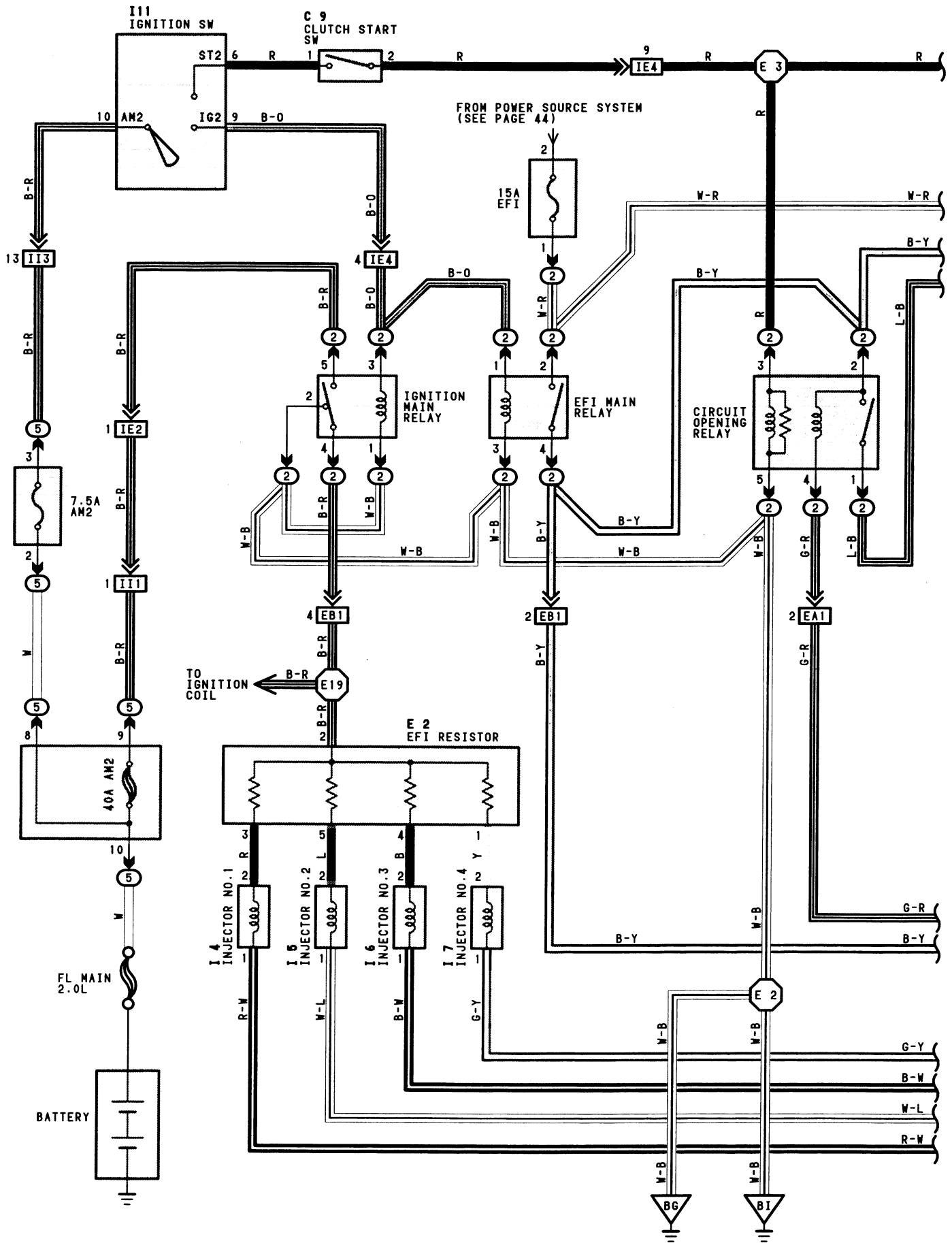

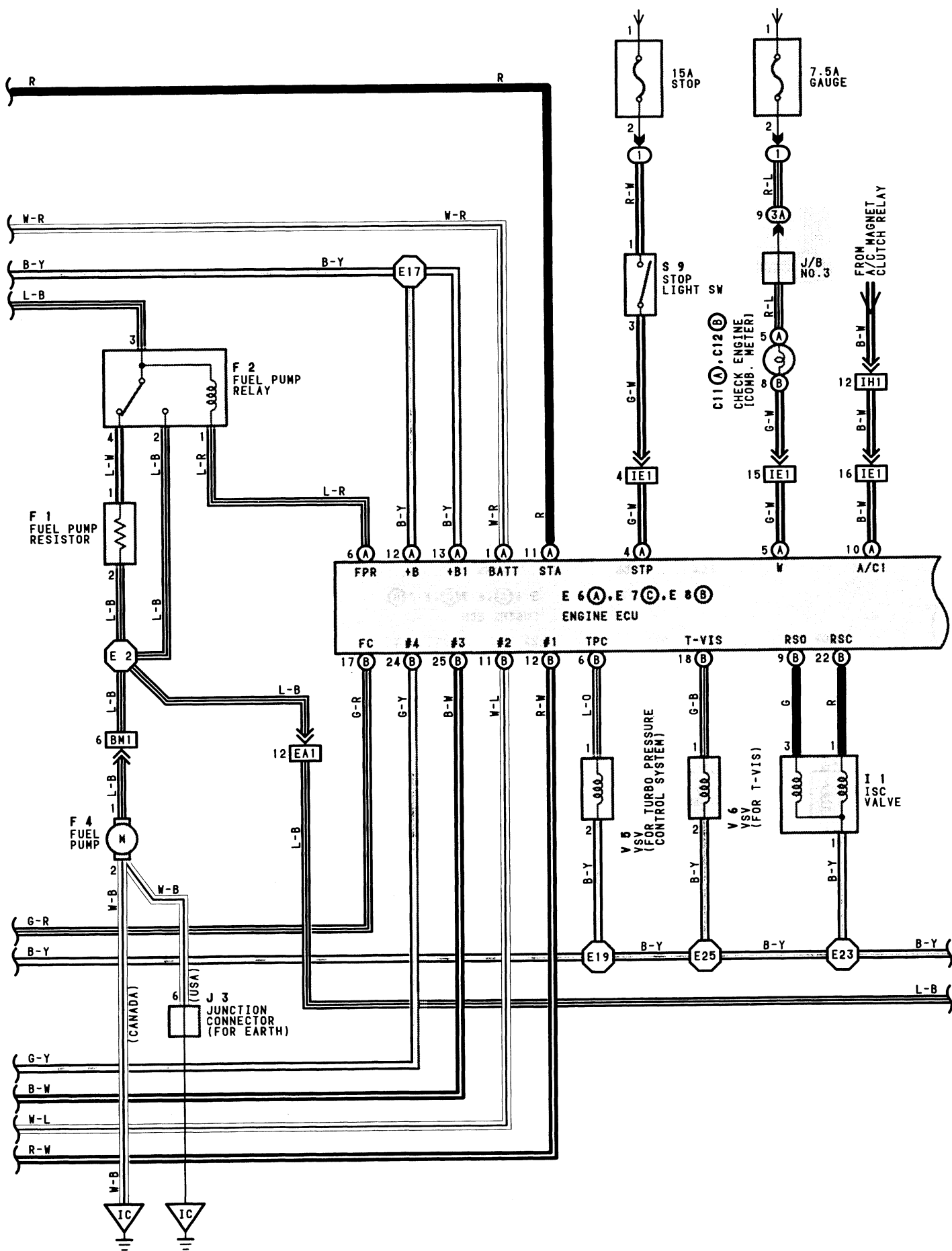



ENGINE CONTROL (3S-GTE)

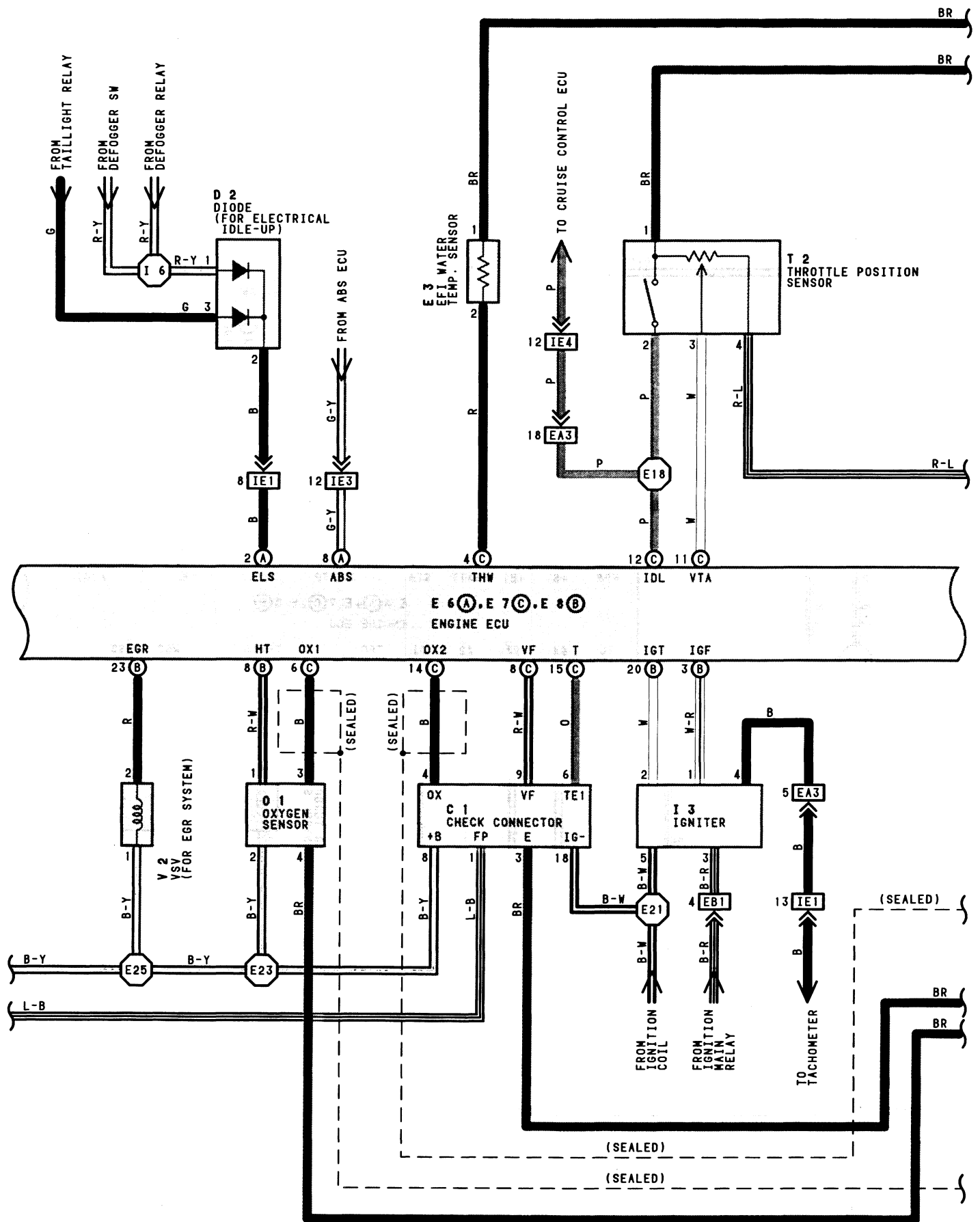

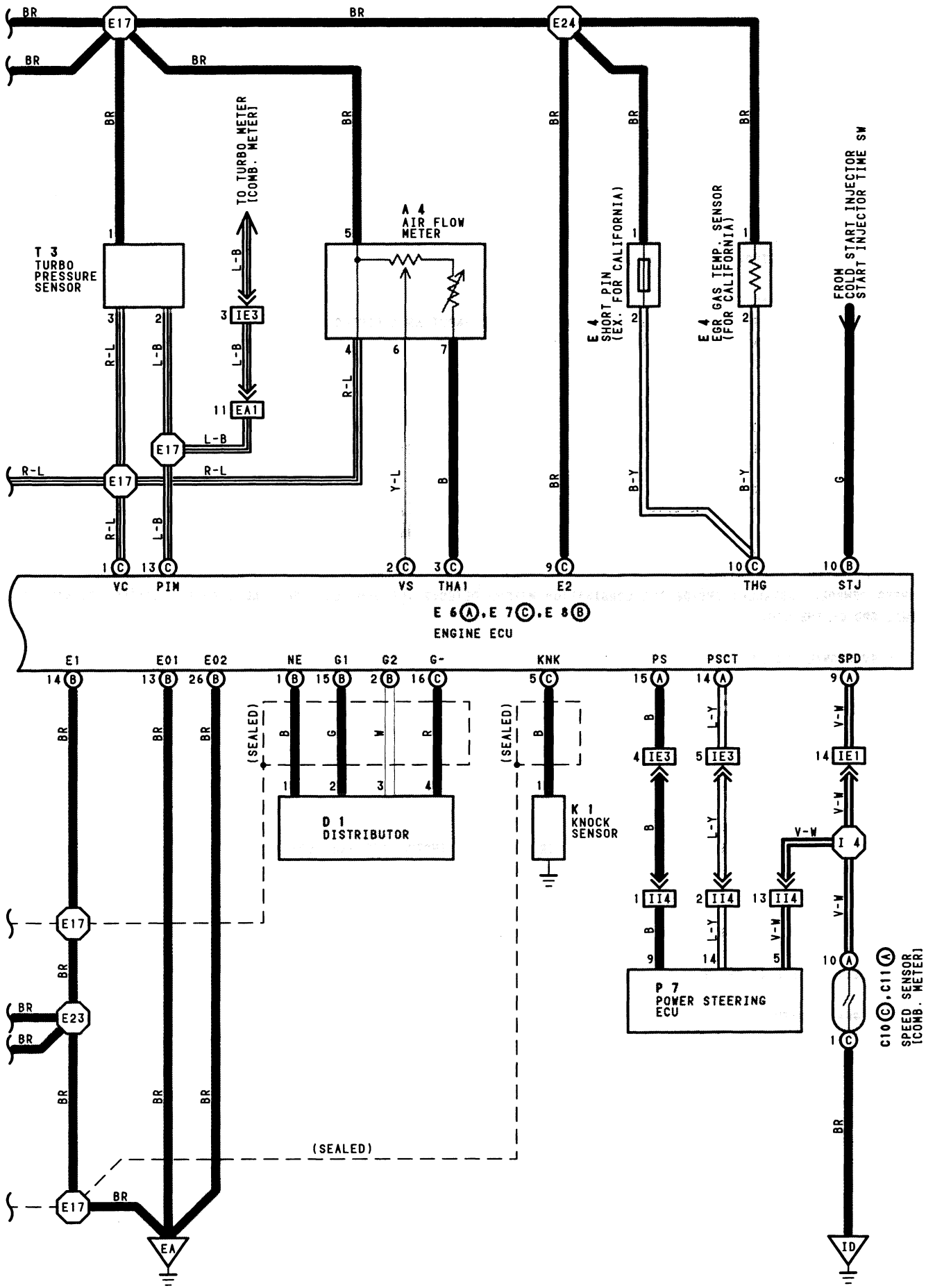



SYSTEM OUTLINE

THE ENGINE CONTROL SYSTEM UTILIZES A MICROCOMPUTER AND MAINTAINS OVERALL CONTROL OF THE ENGINE, TRANSMISSION, ETC. AN OUTLINE OF ENGINE CONTROL IS GIVEN HERE.

1. INPUT SIGNALS

(1) WATER TEMP. SIGNAL SYSTEM

THE WATER TEMP. SENSOR DETECTS THE ENGINE COOLANT TEMP. AND HAS A BUILT-IN THERMISTOR WITH A RESISTANCE WHICH VARIES ACCORDING TO THE WATER TEMP. THUS THE WATER TEMP. IS INPUT IN THE FORM OF A CONTROL SIGNAL TO TERMINAL THW OF THE TCCS ECU.

(2) INTAKE AIR TEMP. SIGNAL SYSTEM

THE INTAKE AIR TEMP. SENSOR IS INSTALLED INSIDE THE AIR FLOW METER AND DETECTS THE INTAKE AIR TEMP., WHICH IS INPUT AS A CONTROL SIGNAL TO TERMINAL THAI OF THE ECU.

(3) OXYGEN SENSOR SIGNAL SYSTEM

THE OXYGEN DENSITY IN THE EXHAUST EMISSIONS IS DETECTED AND INPUT AS A CONTROL SIGNAL TO TERMINAL OX1 OF THE ECU. TO MAINTAIN STABLE DETECTION PERFORMANCE BY THE OX SENSOR, A HEATER IS USED FOR WARMING THE SENSOR. THE HEATER IS ALSO CONTROLLED BY THE ECU (HT).

(4) RPM SIGNAL SYSTEM

CRANKSHAFT POSITION IS DETECTED BY THE PICK-UP COIL INSTALLED INSIDE THE DISTRIBUTOR. CRANKSHAFT POSITION IS INPUT AS A CONTROL SIGNAL TO TERMINAL G1 AND G2 OF THE ECU, AND RPM IS INPUT TO TERMINAL NE.

(5) THROTTLE SIGNAL SYSTEM

THE THROTTLE POSITION SENSOR DETECTS THE THROTTLE VALVE OPENING ANGLE, WHICH IS INPUT AS A CONTROL SIGNAL TO TERMINAL VTA OF THE ECU, OR WHEN THE VALVE IS FULLY CLOSED, TO TERMINAL IDL.

(6) VEHICLE SPEED SIGNAL SYSTEM

THE SPEED SENSOR, INSTALLED INSIDE THE COMBINATION METER, DETECTS THE VEHICLE SPEED AND INPUTS A CONTROL SIGNAL TO TERMINAL SPD OF THE ECU.

(7) A/C SW SIGNAL SYSTEM

THE OPERATING VOLTAGE OF THE A/C MAGNET CLUTCH IS DETECTED AND INPUT IN THE FORM OF A CONTROL SIGNAL TO TERMINAL A/C1 OF THE ECU.

(8) BATTERY SIGNAL SYSTEM

VOLTAGE IS CONSTANTLY APPLIED TO TERMINAL BATT OF THE ECU. WHEN THE IGNITION SW IS TURNED TO ON, VOLTAGE FOR ECU OPERATION IS APPLIED VIA THE EFI MAIN RELAY TO TERMINALS +B AND +B1 OF THE ECU.

(9) INTAKE AIR VOLUME SIGNAL SYSTEM

INTAKE AIR VOLUME IS DETECTED BY THE POTENTIOMETER INSTALLED INSIDE THE AIR FLOW METER AND IS INPUT AS A CONTROL SIGNAL TO TERMINAL VS OF THE ECU. INSIDE THE AIR FLOW METER THERE IS ALSO A SW FOR FUEL PUMP OPERATION, AND WHEN THE MEASURING PLATE OPENS (AIR INTAKE OCCURS), THIS SW TURNS ON AND CURRENT FLOWS TO THE FUEL PUMP TO OPERATE IT.

(10) STOP LIGHT SW SIGNAL SYSTEM

THE STOP LIGHT SW IS USED TO DETECT WHETHER OR NOT THE VEHICLE IS BRAKING AND THE INFORMATION IS INPUT AS A CONTROL SIGNAL TO TERMINAL STP OF THE ECU.

(11) STA SIGNAL SYSTEM

TO CONFIRM THAT THE ENGINE IS CRANKING, THE VOLTAGE APPLIED TO THE STARTER MOTOR DURING CRANKING IS DETECTED AND IS INPUT AS A CONTROL SIGNAL TO TERMINAL STA OF THE ECU.

(12) ENGINE KNOCK SIGNAL SYSTEM

ENGINE KNOCKING IS DETECTED BY THE KNOCK SENSOR AND INPUT AS A CONTROL SIGNAL TO TERMINAL KNK OF THE ECU.

2. CONTROL SYSTEM

* EFI (ELECTRONIC FUEL INJECTION) SYSTEM

THE EFI SYSTEM MONITORS THE ENGINE REVOLUTIONS THROUGH THE SIGNALS EACH SENSOR (INPUT SIGNALS (1) TO (12)) INPUTS TO THE ECU. BASED ON THIS DATA AND THE PROGRAM MEMORIZED IN THE ECU, THE MOST APPROPRIATE FUEL INJECTION TIMING IS DECIDED AND CURRENT IS OUTPUT TO **TERMINAL #1, #2, #3 AND #4** OF THE ECU, CAUSING THE INJECTORS TO OPERATE IT (TO INJECT FUEL). IT IS THIS SYSTEM WHICH, THROUGH THE WORK OF THE ECU, FINELY CONTROLS FUEL INJECTION IN RESPONSE TO DRIVING CONDITIONS.

* ESA (ELECTRONIC SPARK ADVANCE) SYSTEM

THE ESA SYSTEM MONITORS THE ENGINE REVOLUTIONS USING THE SIGNALS (INPUT SIGNALS (1,3,4,6,7,9,11)) INPUT TO THE ECU FROM EACH SENSOR. BASED ON THIS DATA AND THE PROGRAM MEMORIZED IN THE ECU, THE MOST APPROPRIATE IGNITION TIMING IS DECIDED AND CURRENT IS OUTPUT TO **TERMINAL 1GT** OF THE ECU. THIS OUTPUT CONTROLS THE IGNITER TO PRODUCE THE MOST APPROPRIATE IGNITION TIMING FOR THE DRIVING CONDITIONS.

* FUEL PUMP CONTROL SYSTEM

COMPUTER OPERATION OUTPUTS TO **TERMINAL FPR** AND CONTROLS THE FUEL PUMP CONTROL RELAY AND THUS CONTROLS THE FUEL PUMP DRIVE SPEED IN RESPONSE TO CONDITIONS.

* OXYGEN SENSOR HEATER CONTROL SYSTEM

THE OXYGEN SENSOR HEATER CONTROL SYSTEM TURNS THE HEATER TO ON WHEN THE INTAKE AIR VOLUME IS LOW (TEMP. OF EXHAUST EMISSIONS LOW), AND WARMS UP THE OXYGEN SENSOR TO IMPROVE DETECTION PERFORMANCE OF THE SENSOR. THE ECU EVALUATES THE SIGNALS FROM EACH SENSOR (INPUT SIGNALS (1,6,8,9,11)), CURRENT IS OUTPUT TO **TERMINAL HT** AND CONTROLS THE HEATER.

* ISC (IDLE SPEED CONTROL) SYSTEM

THE ISC SYSTEM (ROTARY SOLENOID TYPE) INCREASES THE RPM AND PROVIDES IDLING STABILITY FOR FAST IDLE-UP WHEN THE ENGINE IS COLD AND WHEN THE IDLE SPEED HAS DROPPED DUE TO ELECTRICAL LOAD, ETC. THE ECU EVALUATES THE SIGNALS FROM EACH SENSOR (INPUT SIGNALS (1,4 TO 8,11,13)), OUTPUTS CURRENT TO **TERMINALS RSC AND RSO** AND CONTROLS THE ISC VALVE.

* EGR CONTROL SYSTEM

WITH THE EGR CONTROL SYSTEM, THE ECU EVALUATES THE (INPUT SIGNALS (1,4,10)) FROM EACH SENSOR, CURRENT IS OUTPUT TO **TERMINAL EGR** AND OPERATION OF THE EGR VALVE IS CONTROLLED.

* INTAKE AIR CONTROL SYSTEM

IN THE INTAKE AIR CONTROL SYSTEM, EACH CYLINDER IN THE INTAKE MANIFOLD IS DIVIDED INTO TWO PARTS, WITH AN INTAKE AIR CONTROL VALVE INSTALLED IN THE PASSAGE ON ONE SIDE. THE OPENING AND CLOSING OF THE VALVE PROVIDES THE MOST APPROPRIATE INTAKE AIR FLOW AND, AS WELL AS PREVENTING PERFORMANCE LOSS AT LOW SPEEDS, ALSO IMPROVES FUEL ECONOMY. THE ECU EVALUATES THE SIGNALS FROM EACH SENSOR (INPUT SIGNALS (1,4,5)), OUTPUTS CURRENT TO **TERMINAL T-VIS** CONTROLS THE VSV (FOR T-VIS) AND, CARRIES OUT OPENING AND CLOSING OF THE VALVE.

3. DIAGNOSIS SYSTEM

WITH THE DIAGNOSIS SYSTEM, WHEN THERE IS A MALFUNCTION IN THE ECU SIGNAL SYSTEM, THE MALFUNCTIONING SYSTEM IS RECORDED IN THE MEMORY. THE MALFUNCTIONING SYSTEM CAN THEN BE FOUND BY READING THE DISPLAY (CODE) OF THE CHECK ENGINE WARNING LIGHT.

4. FAIL-SAFE SYSTEM

WHEN A MALFUNCTION OCCURS IN ANY SYSTEM, IF THERE IS A POSSIBILITY OF ENGINE TROUBLE BEING CAUSED BY CONTINUED CONTROL BASED ON THE SIGNALS FROM THAT SYSTEM. THE FAIL-SAFE SYSTEM EITHER CONTROLS THE SYSTEM BY USING DATA (STANDARD VALUES) RECORDED IN THE ECU MEMORY OR ELSE STOPS THE ENGINE.



ENGINE CONTROL (3S-GTE)

SERVICE HINTS

EFI MAIN RELAY

2-4: CLOSED WITH IGNITION SW AT ON OR ST POSITION

E 1 EFI RESISTOR

2-1, 3, 4, 5: 4-8Ω

I 4, I 5, I 6, I 7 INJECTOR

1-2: 2-4Ω

F10 FUEL PUMP RESISTOR

1-2: APPROX. 0.8Ω

E 4 EGR GAS TEMP. SENSOR (FOR CALIFORNIA)

1-2: 69.4-88.5KΩ (50°C, 122°F)
11.89-14.37KΩ (100°C, 212°F)
2.79-3.59KΩ (150°C, 302°F)

A15 AIR FLOW METER

5-6: 200-600Ω (MEASURING PLATE CLOSED)
20-1000Ω (MEASURING PLATE OPEN)

5-4: 200-400Ω
5-7: 15KΩ (-20°C, 4°F)
4-7KΩ (0°C, 32°F)
2-3KΩ (20°C, 68°F)
0.9-1.3KΩ (40°C, 104°F)
0.4-0.7KΩ (60°C, 140°F)

E 2 EFI WATER TEMP. SENSOR

1-2: 5.88KΩ (0°C, 32°F)
2.2-2.7KΩ (20°C, 68°F)
1.14KΩ (40°C, 104°F)
0.584KΩ (60°C, 140°F)
0.29-0.35KΩ (80°C, 176°F)

T 1 THROTTLE POSITION SENSOR

3-4: 3.9-7.25KΩ WITH CLEARANCE BETWEEN LEVER AND STOP SCREW 0MM (0IN.)
2-4: LESS THAN 5.5KΩ WITH CLEARANCE BETWEEN LEVER AND STOP SCREW 0.50MM (0.020IN.)
∞Ω WITH 0.7MM (0.028IN.)
3-4: 0.96-1.79KΩ WITH THROTTLE VALVE FULLY OPEN
1-4: 4.38-8.13KΩ (25°C, 77°F)

E 4, E 5, E 6 ENGINE ECU

VOLTAGE AT ECU CONNECTORS

BATT - E1: 10-14VOLTS
+B, +B1 - E1: 10-14VOLTS (IGNITION SW ON)
IDL - E2: 4.5-5.5VOLTS (IGNITION SW ON AND THROTTLE VALVE OPEN)
VTA - E2: 1.0VOLTS OR LESS (IGNITION SW ON AND THROTTLE VALVE FULLY CLOSED)
3.0-5.0VOLTS (IGNITION SW ON AND THROTTLE VALVE FULLY OPEN)
VC - E2: 4.5-5.5VOLTS (IGNITION SW ON)
VS - E2: 3.7-4.3VOLTS (IGNITION SW ON AND MEASURING PLATE FULLY CLOSED)
0.2-0.5VOLTS OR LESS (IGNITION SW ON AND MEASURING PLATE FULLY OPEN)
1.6-4.1VOLTS (IDLING)
0.5-2.5VOLTS (3000RPM)
THA1 - E2: 1.0-3.0VOLTS (IGNITION SW ON AND INTAKE AIR TEMP. 20°C (68°F))
THW - E2: 0.1-1.0VOLTS (IGNITION SW ON AND COOLANT TEMP. 80°C (176°F))
STA - E1: 6-14VOLTS (CRANKING)
#1, #2, #3, #4 - E01, E02: 10-14VOLTS (IGNITION SW ON)
IGT - E1: 0.8-1.2VOLTS (CRANKING OR IDLING)
TVIS - E1: APPROX. 2.0VOLTS OR LESS WITH IGNITION SW ON AND THROTTLE VALVE FULLY CLOSED } (REGULAR GASOLINE)
10-14VOLTS WITH IGNITION SW ON AND THROTTLE VALVE OPEN }
APPROX. 2.0VOLTS OR LESS IDLING } (PREMIUM GASOLINE)
10-14VOLTS WITH 4200RPM OR MORE }
T - E1: 10-14VOLTS WITH IGNITION SW ON AND CHECK CONNECTOR T-E1 NO CONNECT
APPROX. 1.0VOLTS OR LESS WITH IGNITION SW ON AND CHECK CONNECTOR T-E1 CONNECT
A/C1 - E1: 8-14VOLTS WITH IGNITION SW ON A/C SWITCH ON
RS0, RSC - E1: 9-14VOLTS (IGNITION SW ON)
PIM - E2: 2.5-4.5VOLTS (IGNITION SW ON)
W - E1: 10-14VOLTS (NO TROUBLE (CHECK ENGINE WARNING LIGHT OFF) AND ENGINE RUNNING)

**RESISTANCE AT ECU CONNECTORS
(DISCONNECT WIRING CONNECTOR FROM ECU)**

IDL - E1: INFINITY (THROTTLE VALVE OPEN)
 LESS THAN 2300Ω (THROTTLE VALVE FULLY CLOSED)
 VTA - E2: 3500-10000Ω (THROTTLE VALVE OPEN)
 200-800Ω (THROTTLE VALVE FULLY CLOSED)
 VS - E2: 200-600Ω (MEASURING PLATE FULLY CLOSED)
 20-1200Ω (MEASURING PLATE FULLY OPEN)
 THA1 - E2: 2000-3000Ω (INTAKE AIR TEMP. 20°C, 68°F)
 THW - E2: 200-400Ω (COOLANT TEMP. 80°C, 176°F)
 G1, G2 - G-: 140-180Ω
 NE - G-: 180-220Ω
 RSC, RSO - +B, +B1: 17.7-23.9Ω

○ : PARTS LOCATION

CODE	SEE PAGE	CODE	SEE PAGE	CODE	SEE PAGE	
A 4	21(3S-GTE)	E 7	C	21(3S-GTE)	J 3	22
C 1	21(3S-GTE)	E 8	B	21(3S-GTE)	K 1	21(3S-GTE)
C 9	22(3S-GTE)	F 1		21(3S-GTE)	O 1	21(3S-GTE)
C10	C	F 2		21(3S-GTE)	P 7	23
C11	A	F 4		22	S 9	22
C12	B	I 1		21(3S-GTE)	T 2	21(3S-GTE)
D 1	21(3S-GTE)	I 3		21(3S-GTE)	T 3	21(3S-GTE)
D 2	22	I 4		21(3S-GTE)	V 2	21(3S-GTE)
E 2	21(3S-GTE)	I 5		21(3S-GTE)	V 5	21(3S-GTE)
E 3	21(3S-GTE)	I 6		21(3S-GTE)	V 6	21(3S-GTE)
E 4	21(3S-GTE)	I 7		21(3S-GTE)		
E 6	A	I11		22		

○ : RELAY BLOCKS

CODE	SEE PAGE	RELAY BLOCKS (RELAY BLOCK LOCATION)
1	18	R/B NO.1 (LEFT KICK PANEL)
2	18	R/B NO.2 (ENGINE COMPARTMENT LEFT)
5	17	R/B NO.5 (FRONT LUGGAGE COMPARTMENT RIGHT)

○ : JUNCTION BLOCK AND WIRE HARNESS CONNECTOR

CODE	SEE PAGE	JUNCTION BLOCK AND WIRE HARNESS (CONNECTOR LOCATION)
3A	19	COWL WIRE AND J/B NO.3 (BEHIND COMBINATION METER)

□ : CONNECTOR JOINING WIRE HARNESS AND WIRE HARNESS

CODE	SEE PAGE	JOINING WIRE HARNESS AND WIRE HARNESS (CONNECTOR LOCATION)
EA1	26(3S-GTE)	ENGINE WIRE AND ENGINE ROOM MAIN WIRE (REAR LUGGAGE COMPARTMENT LEFT)
EA3	26(3S-GTE)	ENGINE WIRE AND ENGINE ROOM MAIN WIRE (R/B NO.2 INNER)
EB1	26(3S-GTE)	ENGINE WIRE AND R/B NO.2 (R/B NO.2 INNER)
IE1	28	ENGINE ROOM MAIN WIRE AND COWL WIRE (LEFT KICK PANEL)
IE2		
IE3		
IE4		
IH1	28	COWL WIRE AND A/C SUB WIRE (INSTRUMENT PANEL RIGHT)
II1	30	LUGGAGE ROOM WIRE AND COWL WIRE (RIGHT KICK PANEL)
II3	30	COWL WIRE AND LUGGAGE ROOM WIRE (RIGHT KICK PANEL)
II4		
BM1	32	ENGINE ROOM MAIN WIRE AND COWL WIRE (ROOM PARTITION BOARD LEFT)

▽ : GROUND POINTS

CODE	SEE PAGE	GROUND POINTS LOCATION
EA	26(3S-GTE)	INTAKE MANIFOLD
IC	28	INSTRUMENT PANEL BRACE LH
ID	28	RIGHT KICK PANEL
BG	32	UNDER THE LEFT CENTER PILLAR
BI	32	BACK PANEL CENTER



ENGINE CONTROL (3S-GTE)

○ : SPLICE POINTS

CODE	SEE PAGE	WIRE HARNESS WITH SPLICE POINTS	CODE	SEE PAGE	WIRE HARNESS WITH SPLICE POINTS
E 2	26(3S-GTE)	ENGINE ROOM MAIN WIRE	E23	26(3S-GTE)	ENGINE WIRE
E 3			E24		
E17			E25		
E18	26(3S-GTE)	ENGINE WIRE	I 4	30	COWL WIRE
E19			I 6		
E21					

A 4 BLACK

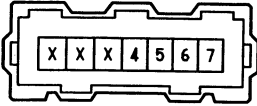

C 1 DARK GRAY

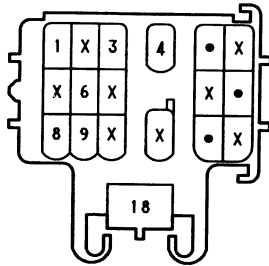

C 9

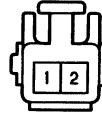

C10 (C) BLUE

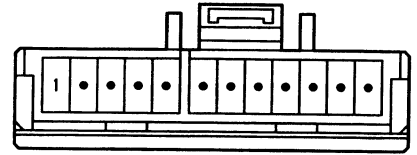

C11 (A)

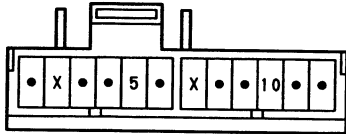

C12 (B) GRAY

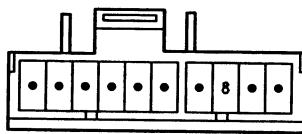

D 1 BLACK

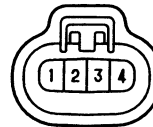

D 2 ORANGE

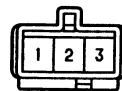

E 2 DARK GRAY

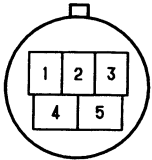

E 3 GREEN



E 4 DARK GRAY



E 6 (A) DARK GRAY

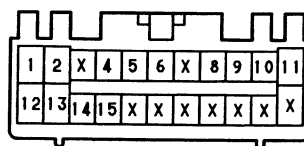

E 7 (C) DARK GRAY

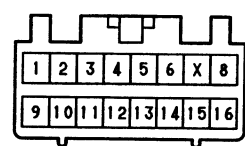

E 8 (B) DARK GRAY

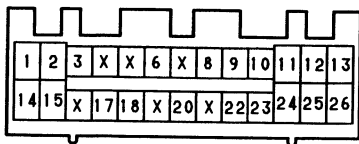

F 1 DARK GRAY



F 2 DARK GRAY

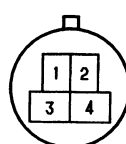

F 4 DARK GRAY

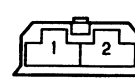

I 1 GRAY

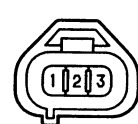

I 3 BLACK



I 4, I 6 BROWN



I 5, I 7 GRAY



I11 BLACK

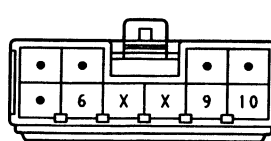

K 1 DARK GRAY



O 1 DARK GRAY



P 7

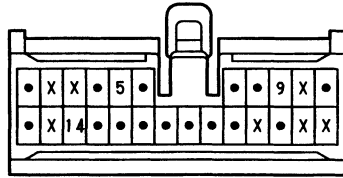

S 9

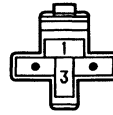

T 2 BLACK

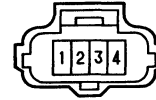

T 3 BLACK

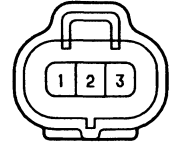

V 2 BROWN



V 5 BLUE



V 6 BROWN





ENGINE CONTROL (5S-FE)

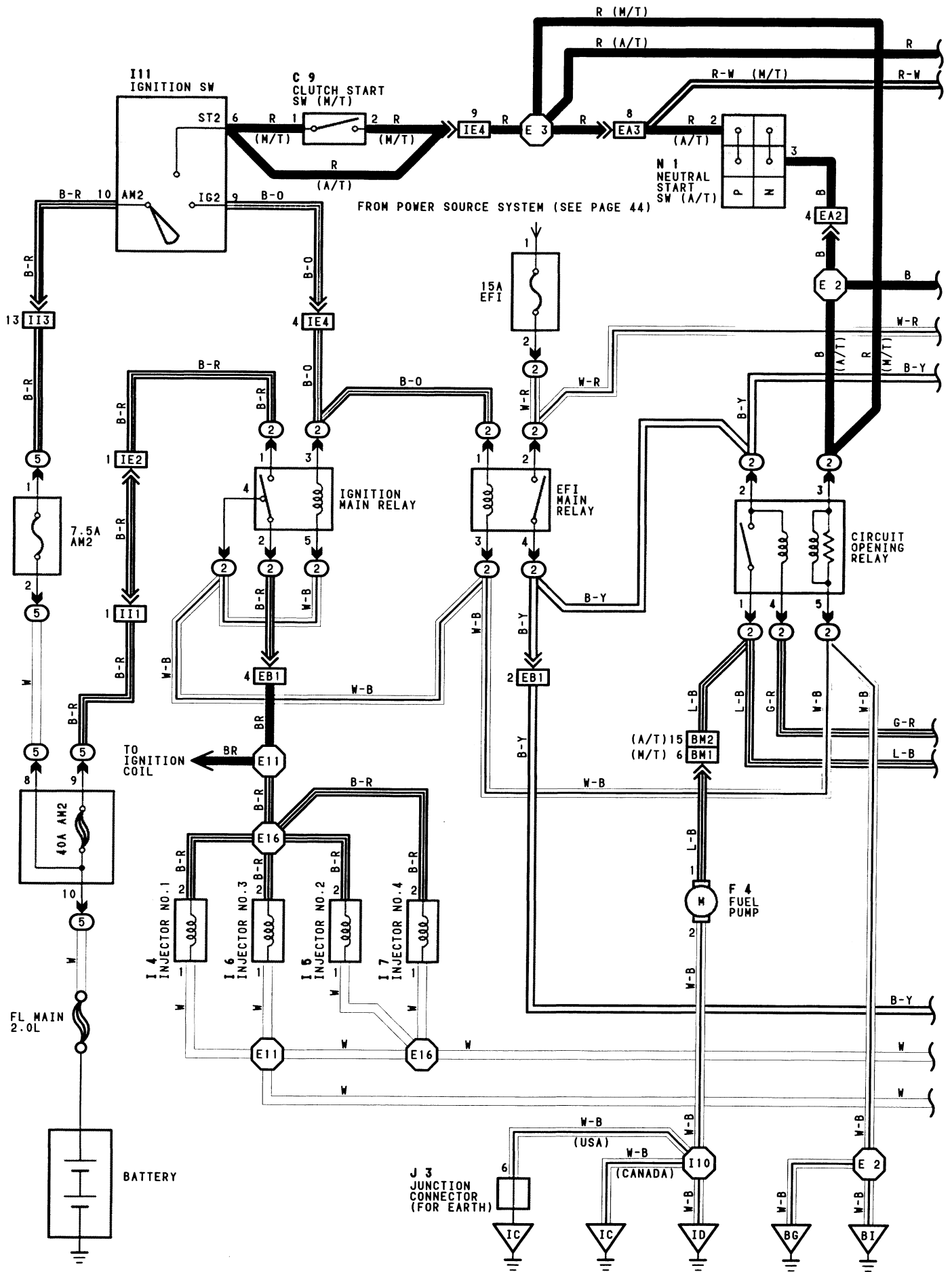

FROM POWER SOURCE SYSTEM (SEE PAGE 44)

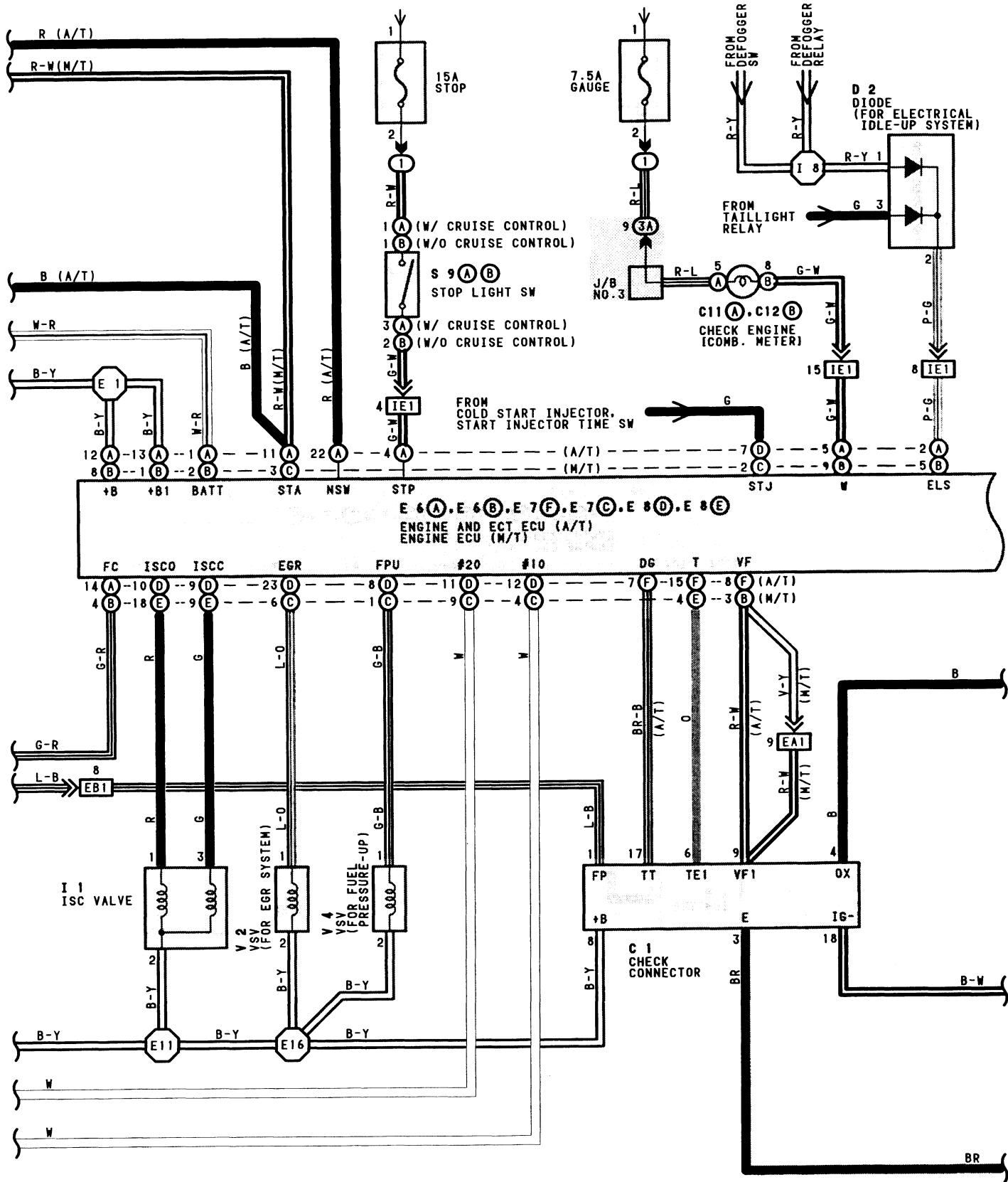



ENGINE CONTROL (5S-FE)

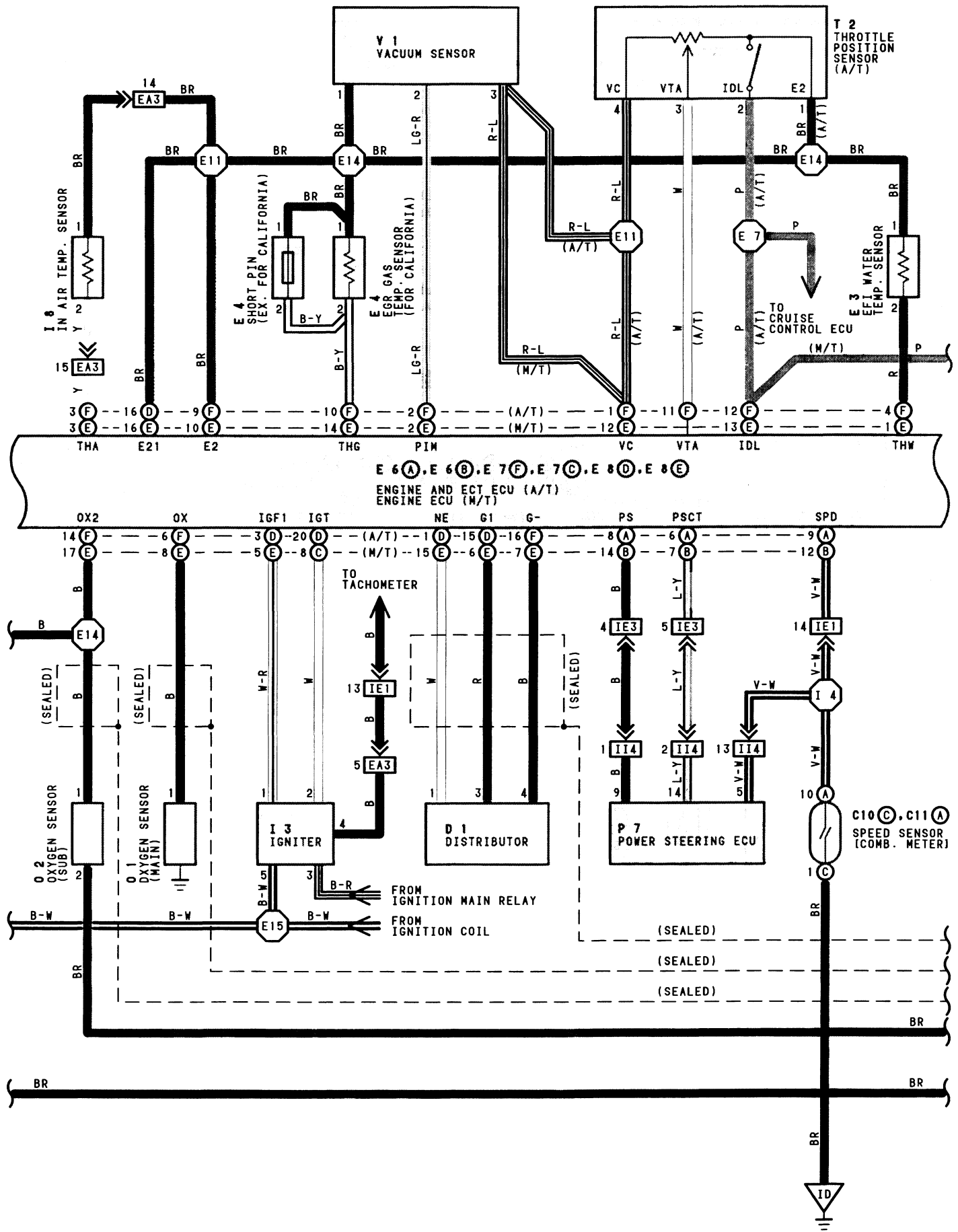

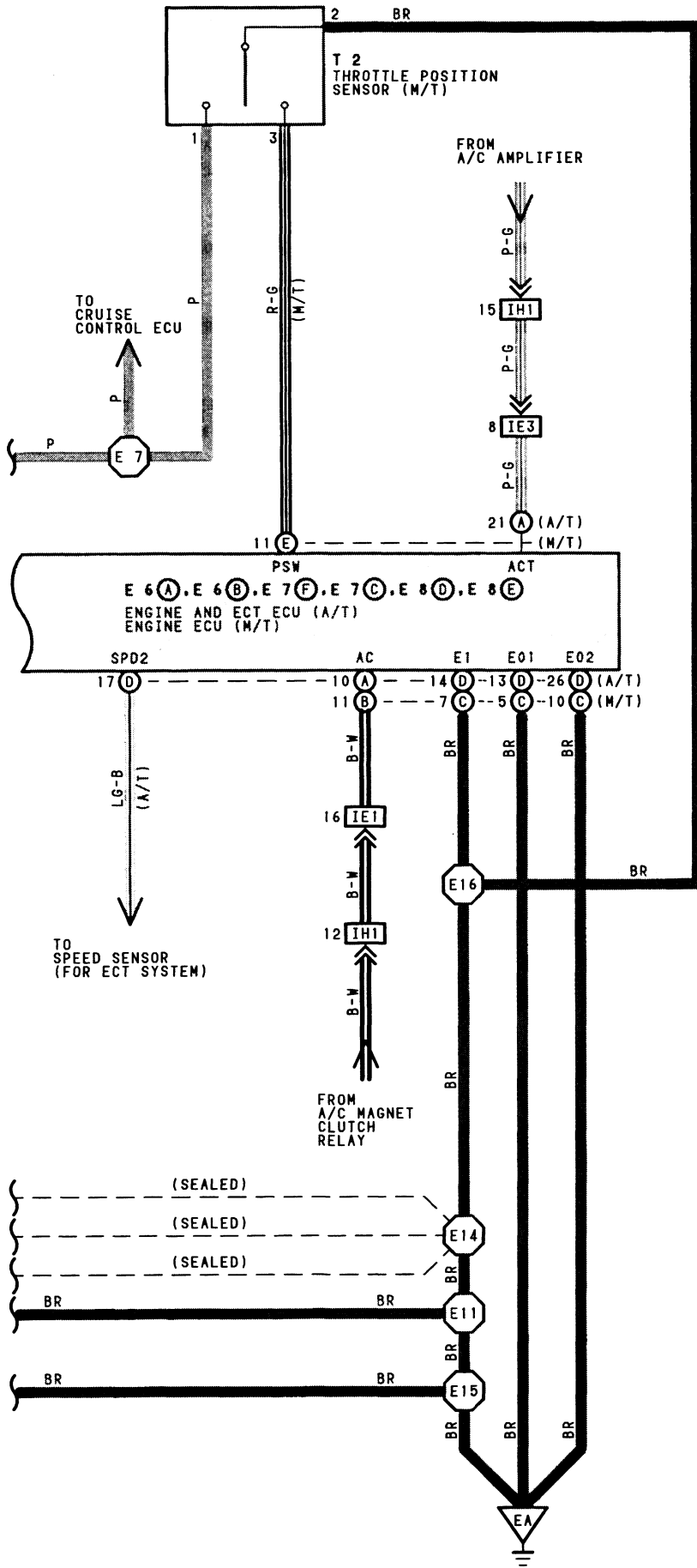



SYSTEM OUTLINE

THE ENGINE CONTROL SYSTEM UTILIZES A MICROCOMPUTER AND MAINTAINS OVERALL CONTROL OF THE ENGINE, TRANSMISSION, ETC. AN OUTLINE OF ENGINE CONTROL IS GIVEN HERE.

1. INPUT SIGNALS

(1) WATER TEMP. SIGNAL SYSTEM

THE WATER TEMP. SENSOR DETECTS THE ENGINE COOLANT TEMP. AND HAS A BUILT-IN THERMISTOR WITH A RESISTANCE WHICH VARIES ACCORDING TO THE WATER TEMP. THUS THE WATER TEMP. IS INPUT IN THE FORM OF A CONTROL SIGNAL TO **TERMINAL THW** OF THE ECU.

(2) INTAKE AIR TEMP. SIGNAL SYSTEM

THE INTAKE AIR TEMP. SENSOR IS DETECTS THE INTAKE AIR TEMP., WHICH IS INPUT AS A CONTROL SIGNAL TO **TERMINAL THA** OF THE ECU.

(3) OXYGEN SENSOR SIGNAL SYSTEM

THE OXYGEN DENSITY IN THE EXHAUST EMISSIONS IS DETECTED AND INPUT AS A CONTROL SIGNAL TO **TERMINAL OX1** AND **OX2** (CALIFORNIA) OF THE ECU.

(4) RPM SIGNAL SYSTEM

CRANKSHAFT POSITION AND ENGINE RPM ARE DETECTED BY THE PICK-UP COIL INSTALLED INSIDE THE DISTRIBUTOR. CRANKSHAFT POSITION IS INPUT AS A CONTROL SIGNAL TO **TERMINAL G1**, OF THE ECU, AND RPM IS INPUT TO **TERMINAL NE**.

(5) THROTTLE SIGNAL SYSTEM

THE THROTTLE POSITION SENSOR DETECTS THE THROTTLE VALVE OPENING ANGLE, WHICH IS INPUT AS A CONTROL SIGNAL TO **TERMINAL VTA (A/T)** OR **PSW (M/T)** OF THE ECU, OR WHEN THE VALVE IS FULLY CLOSED, TO **TERMINAL IDL**

(6) VEHICLE SPEED SIGNAL SYSTEM

THE SPEED SENSOR, INSTALLED INSIDE THE COMBINATION METER, DETECTS THE VEHICLE SPEED AND INPUTS A CONTROL SIGNAL TO **TERMINAL SPD** OF THE ECU.

(7) NEUTRAL START SW SIGNAL SYSTEM (A/T)

THE NEUTRAL START SW DETECTS WHETHER THE SHIFT POSITION IS IN NEUTRAL OR NOT, AND INPUTS A CONTROL SIGNAL TO **TERMINAL NSW** OF THE ECU.

(8) A/C SW SIGNAL SYSTEM

THE OPERATING VOLTAGE OF THE A/C MAGNET CLUTCH IS DETECTED AND INPUT IN THE FORM OF A CONTROL SIGNAL TO **TERMINAL A/C** OF THE ECU.

(9) BATTERY SIGNAL SYSTEM

VOLTAGE IS CONSTANTLY APPLIED TO **TERMINAL BATT** OF THE ECU. WHEN THE IGNITION SW IS TURNED TO ON, VOLTAGE FOR ECU OPERATION IS APPLIED VIA THE EFI MAIN RELAY TO **TERMINALS +B** AND **+B1** OF THE ECU.

(10) INTAKE AIR VOLUME SIGNAL SYSTEM

INTAKE AIR VOLUME IS DETECTED BY THE VACUUM SENSOR AND IS INPUT AS A CONTROL SIGNAL TO **TERMINAL PIM** OF THE ECU.

(11) STA SIGNAL SYSTEM

TO CONFIRM THAT THE ENGINE IS CRANKING, THE VOLTAGE APPLIED TO THE STARTER MOTOR DURING CRANKING IS DETECTED AND IS INPUT AS A CONTROL SIGNAL TO **TERMINAL STA** OF THE ECU.

(12) ELECTRICAL LOAD SIGNAL SYSTEM

THE SIGNAL WHEN SYSTEMS SUCH AS THE REAR WINDOW DEFOGGER, HEADLIGHTS, ETC. WHICH CAUSE A HIGH ELECTRICAL BURDEN ARE ON IS INPUT TO **TERMINAL ELS** AS A CONTROL SIGNAL.

2. CONTROL SYSTEM

• EFI (ELECTRONIC FUEL INJECTION) SYSTEM

THE EFI SYSTEM MONITORS THE ENGINE REVOLUTIONS THROUGH THE SIGNALS EACH SENSOR (INPUT SIGNALS (1) TO (12)) INPUTS TO THE ECU. BASED ON THIS DATA AND THE PROGRAM MEMORIZED IN THE ECU, THE MOST APPROPRIATE FUEL INJECTION TIMING IS DECIDED AND CURRENT IS OUTPUT TO **TERMINALS #10** AND **#20** OF THE ECU, CAUSING THE INJECTORS TO OPERATE IT (TO INJECT FUEL). IT IS THIS SYSTEM WHICH, THROUGH THE WORK OF THE ECU, FINELY CONTROLS FUEL INJECTION IN RESPONSE TO DRIVING CONDITIONS.

DURING ENGINE CRANKING (SIGNAL INPUT TO **TERMINAL STA**) OR FOR APPROX. 2 SECONDS AFTER NE SIGNAL INPUT, ECU OPERATION ENERGIZES (POINT CLOSED) THE FUEL PUMP CIRCUIT INSIDE THE CIRCUIT OPENING RELAY, CAUSING THE FUEL PUMP TO OPERATE.

• ESA (ELECTRONIC SPARK ADVANCE) SYSTEM

THE ESA SYSTEM MONITORS THE ENGINE REVOLUTIONS USING THE SIGNALS (INPUT SIGNALS (1,4,5,10,11)) INPUT TO THE ECU FROM EACH SENSOR. BASED ON THIS DATA AND THE PROGRAM MEMORIZED IN THE ECU, THE MOST APPROPRIATE IGNITION TIMING IS DECIDED AND CURRENT IS OUTPUT TO **TERMINAL IGT** OF THE ECU. THIS OUTPUT CONTROLS THE IGNITER TO PRODUCE THE MOST APPROPRIATE IGNITION TIMING FOR THE DRIVING CONDITIONS.

• ISC (IDLE SPEED CONTROL) SYSTEM

THE ISC SYSTEM (ROTARY SOLENOID TYPE) INCREASES THE RPM AND PROVIDES IDLING STABILTY FOR FAST IDLE-UP WHEN THE ENGINE IS COLD AND WHEN THE IDLE SPEED HAS DROPPED DUE TO ELECTRICAL LOAD, ETC. THE ECU EVALUATES THE SIGNALS FROM EACH SENSOR (INPUT SIGNALS (1,4 TO 8,11,12)), OUTPUTS CURRENT TO **TERMINAL ISCO** AND **ISCC**, AND CONTROLS THE ISC VALVE.

• EGR CONTROL SYSTEM

THE EGR CUT CONTROL SYSTEM CONTROLS THE VSV (FOR EGR) BY EVALUATING THE SIGNALS FROM EACH SENSOR INPUT TO THE ECU (INPUT SIGNALS (1,5,6,9)) AND BY SENDING OUTPUT TO TERMINAL EGR OF THE ECU.

• A/C CUT CONTROL SYSTEM

WHEN THE VEHICLE SUDDENLY ACCELERATES FROM LOW ENGINE SPEED, THIS SYSTEM CUTS OFF AIR CONDITIONER OPERATION FOR A FIXED PERIOD OF TIME IN RESPONSE TO THE VEHICLE SPEED AND THROTTLE VALVE OPENING ANGLE IN ORDER TO MAINTAIN ACCELERATION PERFORMANCE.

THE ECU RECEIVES INPUT SIGNALS (5, 6), AND OUTPUTS SIGNALS TO TERMINAL ACT.

• OVERDRIVE CONTROL SYSTEM

THE ECU CONTROLS THE O/D SOLENOID OF THE AUTOMATIC TRANSAXLE IN RESPONSE TO SIGNALS FROM EACH SENSOR (INPUT SIGNALS (1,4,5,6, AND 10)) IN ORDER TO MAINTAIN DRIVABILITY AND ACCELERATION PERFORMANCE.

THE ECU OUTPUTS A SIGNAL FROM TERMINAL O/D TO CONTROL THE O/D SOLENOID.

• FUEL PUMP CONTROL SYSTEM

COMPUTER OPERATION OUTPUTS TO TERMINAL FC AND CONTROLS THE FUEL PUMP CONTROL RELAY AND THUS CONTROLS THE FUEL PUMP DRIVE SPEED IN REPOSE TO CONDITIONS.

• FUEL PRESSURE CONTROL SYSTEM

THE FUEL PRESSURE UP SYSTEM CAUSES THE VSV (FOR FUEL PRESSURE UP) TO COME ON FOR HIGH TEMP. STARTS IN ORDER TO INCREASE THE FUEL PRESSURE, IMPROVE STARTABILITY AT HIGH TEMPERATURES AND PROVIDE STABLE IDLING.

THE ECU EVALUATES THE INPUT SIGNALS FROM EACH SENSOR (1,2,10,11), OUTPUT CURRENT TO TERMINAL FPU AND CONTROLS THE VSV.

3. DIAGNOSIS SYSTEM

WITH THE DIAGNOSIS SYSTEM, WHEN THERE IS A MALFUNCTIONING IN THE ECU SIGNAL SYSTEM, THE MALFUNCTION SYSTEM IS RECORDED IN THE MEMORY. THE MALFUNCTIONING SYSTEM CAN THEN BE FOUND BY READING THE DISPLAY (CODE) OF THE CHECK ENGINE WARNING LIGHT.

4. FAIL-SAFE SYSTEM

WHEN A MALFUNCTION OCCURS IN ANY SYSTEM, IF THERE IS A POSSIBILITY OF ENGINE TROUBLE BEING CAUSED BY CONTINUED CONTROL BASED ON THE SIGNALS FROM THAT SYSTEM, THE FAIL-SAFE SYSTEM EITHER CONTROLS THE SYSTEM BY USING DATA (STANDARD VALUES) RECORDED IN THE ECU MENORY OR ELSE STOPS THE ENGINE.

SERVICE HINTS

E 6,E 7,E 8 ENGINE ECU

VOLTAGE AT ECU WIRING CONNECTORS

BATT-E1:ALWAYS 10.0-14.0VOLTS

+B-E1:10.0-14.0VOLTS (IGNITION SW AT ON POSITION)

+B1-E1:10.0-14.0VOLTS (IGNITION SW AT ON POSITION)

IDL-E2: 8.0-14.0VOLTS (IGNITION SW ON AND THROTTLE VALVE OPEN)

VC-E2: 4.5- 5.5VOLTS (IGNITION SW AT ON POSITION)

PIM-E2: 3.3- 3.9VOLTS (IGNITION SW AT ON POSITION, ATMOSFERIC PRESSURE)

#10,#20-E01,E02:10.0-14.0VOLTS (IGNITION SW AT ON POSITION)

THA-E2: 1.7- 3.1VOLTS (IGNITION SW ON AND INTAKE AIR TEMP. 20°C, 68°F)

THW-E2: 0.3- 0.8VOLTS (IGNITION SW ON AND COOLANT TEMP. 80°C, 176°F)

STA-E1: 6.0-14.0VOLTS (ENGINE CRANKING)

IGT-E1: 0.8- 1.2VOLTS (ENGINE CRANKING OR IDLING)

W-E1: 8.0-14.0VOLTS (NO TROUBLE AND ENGINE RUNNING)

A/C-E1: 8.0-14.0VOLTS (IGNITION SW ON AND AIR CONDITIONING ON)

ACT-E1: 4.5- 5.5VOLTS (IGNITION SW ON AND AIR CONDITIONING ON)

T-E1:10.0-14.0VOLTS (IGNITION SW ON AND CHECK CONNECTOR TE1-E1 NOT CONNECTED)

1.0VOLTS OR LESS (IGNITION SW ON AND CHECK CONNECTOR TE1-E1 CONNECTED)

NSW-E1:0-2VOLTS WITH NEUTRAL START SW AT "P" OR "N" RANGE

6-14VOLTS WITH NEUTRAL START SW AT EXCEPT "P" OR "N" RANGE

B/K-E1:10-14VOLTS WITH STOP LIGHT SW ON (BRAKE PEDAL DEPRESSED)

ISCC:8-14VOLTS WITH IGNITION SW AT ON POSITION

ISCO:8-14VOLTS WITH IGNITION SW AT ON POSITION

RESISTANCE AT ECU WIRING CONNECTORS

(DISCONNECT WIRING CONNECTOR)

IDL-E1:INFINITY (THROTTLE VALVE OPEN)

2.3K Ω (A/T), 0 Ω (M/T) OR LESS (THROTTLE VALVE FULLY CLOSED)

PSW-E1: 0 Ω (M/T) (THROTTLE VALVE FULLY OPEN)

INFINITY (M/T) (THROTTLE VALVE FULLY CLOSED)

VC-E2: 3.0- 7.0K Ω

THA-E2: 2.0- 3.0K Ω (INTAKE AIR TEMP. 20°C, 68°F)

THW-E2: 0.2- 0.4K Ω (COOLANT TEMP. 80°C, 176°F)

G1,NE-G-:0.17-0.21K Ω

ISCC,ISCO-+B,+B1:19.3-22.3 Ω



ENGINE CONTROL (5S-FE)

○ : PARTS LOCATION

CODE	SEE PAGE	CODE	SEE PAGE	CODE	SEE PAGE	
C 1	20(5S-FE)	E 7	F	20(5S-FE)	J 3	22
C 9	22	E 8	D	20(5S-FE)	N 1	20(5S-FE)
C10	C	22	E	20(5S-FE)	O 1	20(5S-FE)
C11	A	22	F 4	22	O 2	20(5S-FE)
C12	B	22	I 1	20(5S-FE)	P 7	23
D 1	20(5S-FE)	I 3	20(5S-FE)	S 9	A	22
D 2	22	I 4	20(5S-FE)	B	22	
E 3	20(5S-FE)	I 5	20(5S-FE)	T 2	A	20(5S-FE)
E 4	20(5S-FE)	I 6	20(5S-FE)	B	20(5S-FE)	
E 6	A	20(5S-FE)	I 7	20(5S-FE)	V 1	20(5S-FE)
	B	20(5S-FE)	I 8	20(5S-FE)	V 2	20(5S-FE)
E 7	C	20(5S-FE)	I11	22	V 4	20(5S-FE)

○ : RELAY BLOCKS

CODE	SEE PAGE	RELAY BLOCKS (RELAY BLOCK LOCATION)
1	18	R/B NO.1 (LEFT KICK PANEL)
2	18	R/B NO.2 (ENGINE COMPARTMENT LEFT)
5	17	R/B NO.5 (FRONT LUGGAGE COMPARTMENT RIGHT)

○ : JUNCTION BLOCK AND WIRE HARNESS CONNECTOR

CODE	SEE PAGE	JUNCTION BLOCK AND WIRE HARNESS (CONNECTOR LOCATION)
3A	19	COWL WIRE AND J/B NO.3 (BEHIND COMBINATION METER)

□ : CONNECTOR JOINING WIRE HARNESS AND WIRE HARNESS

CODE	SEE PAGE	JOINING WIRE HARNESS AND WIRE HARNESS (CONNECTOR LOCATION)
EA1	24(5S-FE)	ENGINE WIRE AND ENGINE ROOM MAIN WIRE (REAR LUGGAGE COMPARTMENT LEFT)
EA2		
EA3	24(5S-FE)	ENGINE WIRE AND ENGINE ROOM MAIN WIRE (R/B NO.2 INNER)
EB1	24(5S-FE)	ENGINE WIRE AND R/B NO.2 (R/B NO.2 INNER)
IE1	28	ENGINE ROOM MAIN WIRE AND COWL WIRE (LEFT KICK PANEL)
IE2		
IE3		
IE4		
IH1	28	COWL WIRE AND A/C SUB WIRE (INSTRUMENT PANEL RIGHT)
II1	30	LUGGAGE ROOM WIRE AND COWL WIRE (RIGHT KICK PANEL)
II3	30	COWL WIRE AND LUGGAGE ROOM WIRE (RIGHT KICK PANEL)
II4		
BM1	32	ENGINE ROOM MAIN WIRE AND COWL WIRE (ROOM PARTITION BOARD LEFT)
BM2	32	COWL WIRE AND ENGINE ROOM MAIN WIRE (ROOM PARTITION BOARD LEFT)

▽ : GROUND POINTS

CODE	SEE PAGE	GROUND POINTS LOCATION
EA	24(5S-FE)	INTAKE MANIFOLD
IC	28	INSTRUMENT PANEL BRACE LH
ID	28	RIGHT KICK PANEL
B6	32	UNDER THE LEFT CENTER PILLAR
BI	32	BACK PANEL CENTER

○ : SPLICE POINTS

CODE	SEE PAGE	WIRE HARNESS WITH SPLICE POINTS	CODE	SEE PAGE	WIRE HARNESS WITH SPLICE POINTS
E 1	24(5S-FE)	ENGINE ROOM MAIN WIRE	E14	24(5S-FE)	ENGINE WIRE
E 2			E15		
E 3			E16		
E 7	24(5S-FE)	ENGINE WIRE	I 8	30	COWL WIRE
E11			I10		



ENGINE COMPARTMENT COOLING FAN(3S-GTE)

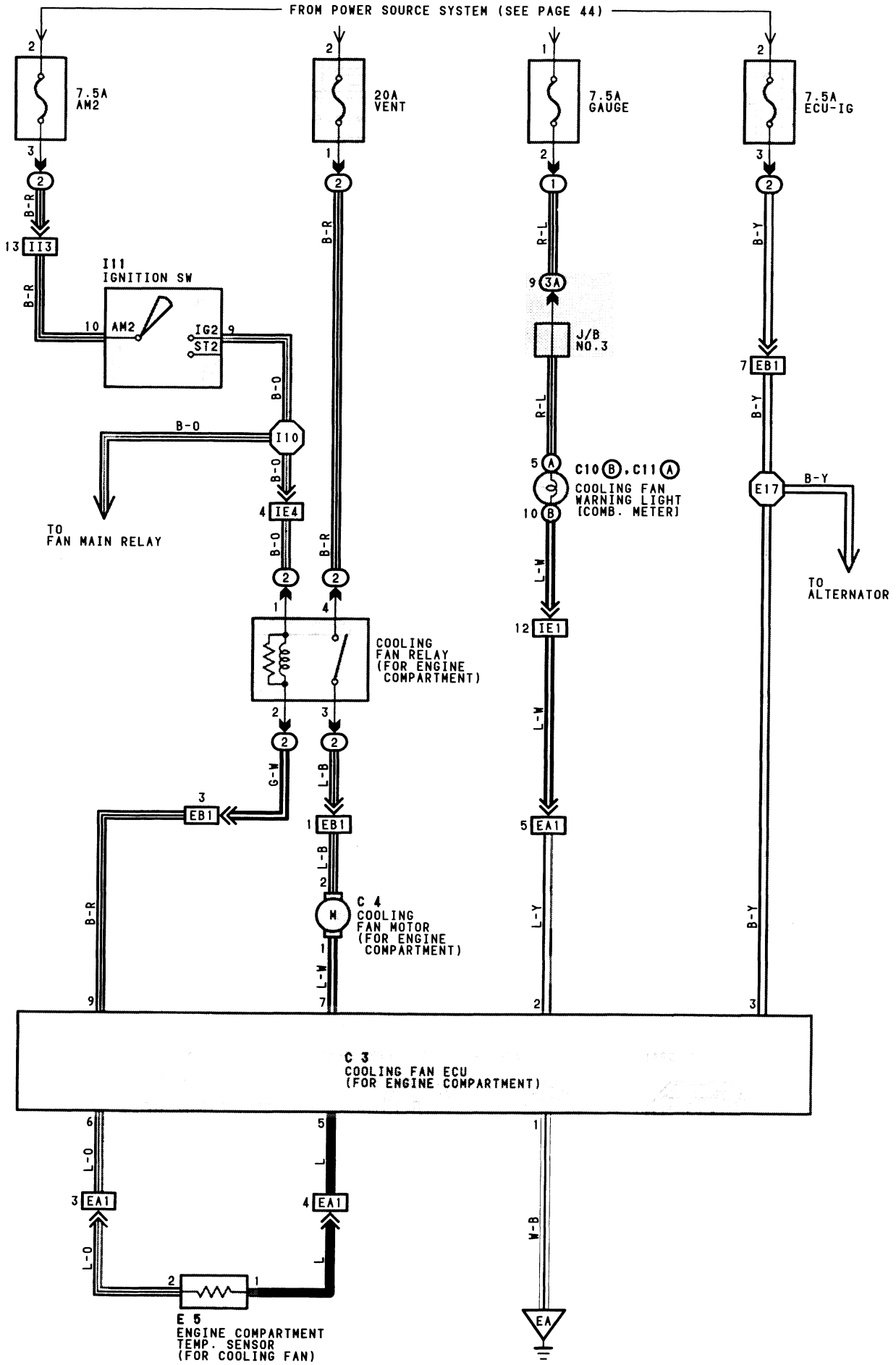

SERVICE HINTS

COOLING FAN RELAY

- 1-GROUND: APPROX. 12VOLTS WITH IGNITION SW AT ON OR ST POSITION
 3-4 : OPEN WITH IGNITION SW AT ON OR ST POSITION AND ENGINE COMPARTMENT TEMP. BELOW 55°C(131°F)

C 3 COOLING FAN ECU

- 1-GROUND: ALWAYS CONTINUITY
 3-1 : APPROX. 12VOLTS WITH IGNITION SW AT ON POSITION
 9-1 : 0VOLTS WITH IGNITION SW AT ON OR ST POSITION AND ENGINE COMPARTMENT TEMP. MORE THAN 70°C(158°F)

○ : PARTS LOCATION

CODE	SEE PAGE	CODE	SEE PAGE	CODE	SEE PAGE
C 3	21(3S-GTE)	C10	B 22	E 5	21(3S-GTE)
C 4	21(3S-GTE)	C11	A 22	I11	22

○ : RELAY BLOCKS

CODE	SEE PAGE	RELAY BLOCKS (RELAY BLOCK LOCATION)
2	18	R/B NO.2 (ENGINE COMPARTMENT LEFT)

○ : JUNCTION BLOCK AND WIRE HARNESS CONNECTOR

CODE	SEE PAGE	JUNCTION BLOCK AND WIRE HARNESS (CONNECTOR LOCATION)
3A	19	COWL WIRE AND J/B NO.3 (BEHIND COMBINATION METER)

□ : CONNECTOR JOINING WIRE HARNESS AND WIRE HARNESS

CODE	SEE PAGE	JOINING WIRE HARNESS AND WIRE HARNESS (CONNECTOR LOCATION)
EA1	24(3S-GTE)	ENGINE ROOM MAIN WIRE AND ENGINE WIRE (REAR LUGGAGE COMPARTMENT LEFT)
EB1	24(3S-GTE)	ENGINE WIRE AND R/B NO.2 (R/B NO.2 INNER)
IE1	28	ENGINE ROOM MAIN WIRE AND COWL WIRE (LEFT KICK PANEL)
IE4		
II3	30	LUGGAGE ROOM WIRE AND COWL WIRE (RIGHT KICK PANEL)

▽ : GROUND POINTS

CODE	SEE PAGE	GROUND POINTS LOCATION
EA	24(3S-GTE)	INTAKE MANIFOLD

○ : SPLICE POINTS

CODE	SEE PAGE	WIRE HARNESS WITH SPLICE POINTS	CODE	SEE PAGE	WIRE HARNESS WITH SPLICE POINTS
E17	26(3S-GTE)	ENGINE WIRE	I10	30	COWL WIRE

C 3 GRAY

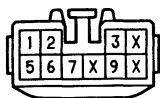

C 4

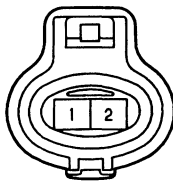

C10 (A) BLUE

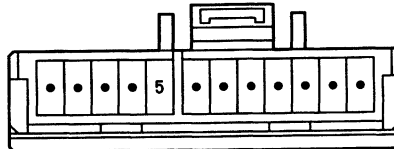

C11 (B)

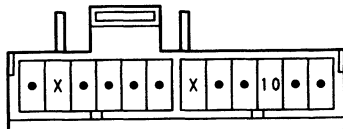

E 5 BLACK



I11 BLACK

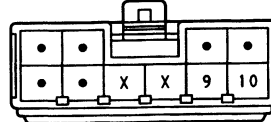

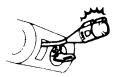

LIGHT AUTO TURN OFF

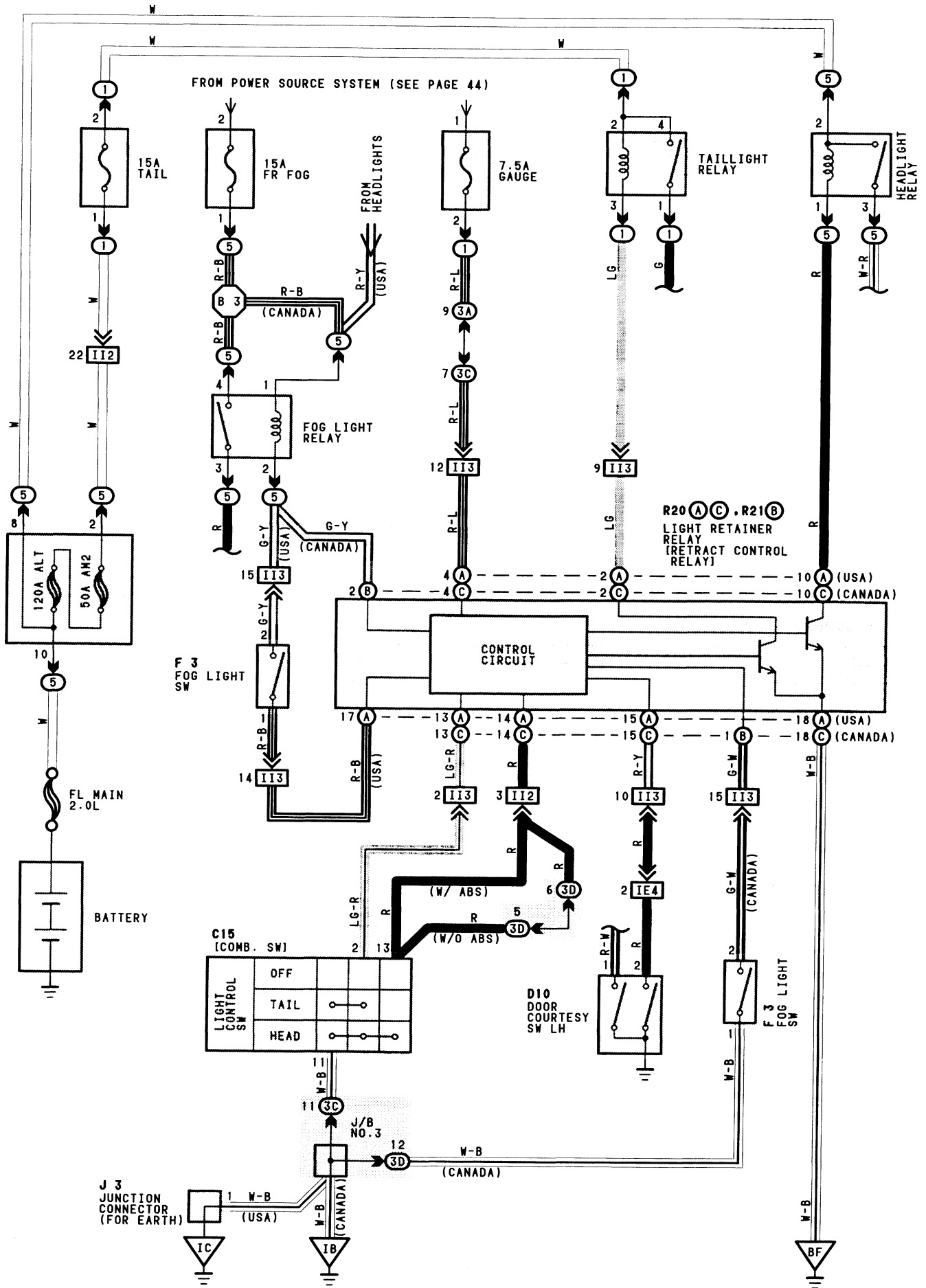

SYSTEM OUTLINE

WITH THE IGNITION SW TURNED ON, THE CURRENT FLOWS TO TERMINAL (A) 4 (USA), (C) 4 (CANADA) OF THE RETRACT CONTROL RELAY THROUGH GAUGE FUSE.

VOLTAGE IS APPLIED AT ALL TIMES TO TERMINAL (A) 2 (USA), (C) 2 (CANADA) OF THE RETRACT CONTROL RELAY. THROUGH THE TAILLIGHT RELAY COIL, AND TO TERMINAL (A) 10 (USA), (C) 10 (CANADA) THROUGH THE HEADLIGHT RELAY COIL.

1. NORMAL LIGHTING OPERATION

<TURN TAILLIGHT ON>

WITH LIGHT CONTROL SW TURNED TO TAILLIGHT POSITION, A SIGNAL IS INPUT INTO TERMINAL (A) 13 (USA), (C) 13 (CANADA) OF THE RETRACT CONTROL RELAY. ACCORDING TO THIS SIGNAL, THE CURRENT FLOWING TO TERMINAL (A) 2 (USA), (C) 2 (CANADA) OF THE RELAY FLOWS FROM TERMINAL (A) 18 (USA), (C) 18 (CANADA) → TO GROUND AND TAILLIGHT RELAY CAUSES TAILLIGHT TO TURN ON.

<TURN HEADLIGHT ON>

WITH LIGHT CONTROL SW TURNED TO HEADLIGHT POSITION, A SIGNAL IS INPUT INTO TERMINALS (A) 13 (USA), (C) 13 (CANADA) AND (A) 14 (USA), (C) 14 (CANADA) OF THE RETRACT CONTROL RELAY. ACCORDING TO THIS SIGNAL, THE CURRENT FLOWING TO TERMINAL (A) 10 (USA), (C) 10 (CANADA) OF THE RELAY FLOWS TO TERMINAL (A) 18 (USA), (C) 18 (CANADA) → TO GROUND IN THE HEADLIGHT CIRCUIT, AND CAUSES TAILLIGHT AND HEADLIGHT RELAY TO TURN THE LIGHT ON. THE TAILLIGHT CIRCUIT IS SAME AS ABOVE.

2. LIGHT AUTO TURN OFF OPERATION

WITH LIGHTS ON AND IGNITION SW TURNED OFF (INPUT SIGNAL GOES TO TERMINAL (A) 4 (USA), (C) 4 (CANADA) OF THE RELAY), WHEN DOOR ON DRIVER'S SIDE IS OPENED (INPUT SIGNAL GOES TO TERMINAL (A) 15 (USA), (C) 15 (CANADA) OF THE RELAY), THE RELAY OPERATES AND THE CURRENT IS CUT OFF WHICH FLOWS FROM TERMINAL (A) 2 (USA), (C) 2 (CANADA) OF THE RELAY TO TERMINAL (A) 18 (USA), (C) 18 (CANADA) IN TAILLIGHT CIRCUIT AND FROM TERMINAL (A) 10 (USA), (C) 10 (CANADA) TO TERMINAL (A) 18 (USA), (C) 18 (CANADA) IN HEADLIGHT CIRCUIT.

AS A RESULT, ALL LIGHTS ARE TURNED OFF AUTOMATICALLY.

SERVICE HINTS

R20 (A) LIGHT RETAINER RELAY [RETRACT CONTROL RELAY] (USA)

- (A) 4-GROUND: APPROX. 12VOLTS WITH IGNITION SW AT ON POSITION
- (A) 2-GROUND: ALWAYS APPROX. 12VOLTS
- (A) 10-GROUND: ALWAYS APPROX. 12VOLTS
- (A) 15-GROUND: CONTINUITY WITH DRIVER'S DOOR OPEN
- (A) 18-GROUND: ALWAYS CONTINUITY
- (A) 13-GROUND: CONTINUITY WITH LIGHT CONTROL SW AT TAIL OR HEAD POSITION
- (A) 14-GROUND: CONTINUITY WITH LIGHT CONTROL SW AT HEAD POSITION
- (A) 17-GROUND: APPROX. 12VOLTS WITH LIGHT CONTROL SW AT HEAD POSITION, DIMMER SW AT LOW POSITION AND FOG LIGHT SW ON

R20 (C), R21 (B) LIGHT RETAINER RELAY [RETRACT CONTROL RELAY] (CANADA)

- (C) 4-GROUND: APPROX. 12VOLTS WITH IGNITION SW AT ON POSITION
- (C) 2-GROUND: ALWAYS APPROX. 12VOLTS
- (C) 10-GROUND: ALWAYS APPROX. 12VOLTS
- (C) 15-GROUND: CONTINUITY WITH DRIVER'S DOOR OPEN
- (C) 18-GROUND: ALWAYS CONTINUITY
- (C) 13-GROUND: CONTINUITY WITH LIGHT CONTROL SW AT TAIL OR HEAD POSITION
- (C) 14-GROUND: CONTINUITY WITH LIGHT CONTROL SW AT HEAD POSITION
- (B) 1-GROUND: CONTINUITY WITH FOG LIGHT SW ON
- (B) 2-GROUND: ALWAYS APPROX. 12VOLTS



LIGHT AUTO TURN OFF

○ : PARTS LOCATION

CODE	SEE PAGE	CODE	SEE PAGE	CODE	SEE PAGE
C15	22	J 3	22	R21	B 23
D10	23	R20	A 23		
F 3	22		C 23		

○ : RELAY BLOCKS

CODE	SEE PAGE	RELAY BLOCKS (RELAY BLOCK LOCATION)
1	18	R/B NO.1 (LEFT KICK PANEL)
5	17	R/B NO.5 (FRONT LUGGAGE COMPARTMENT RIGHT)

○ : JUNCTION BLOCK AND WIRE HARNESS CONNECTOR

CODE	SEE PAGE	JUNCTION BLOCK AND WIRE HARNESS (CONNECTOR LOCATION)
3A	19	COWL WIRE AND J/B NO.3 (BEHIND COMBINATION METER)
3C		
3D		

□ : CONNECTOR JOINING WIRE HARNESS AND WIRE HARNESS

CODE	SEE PAGE	JOINING WIRE HARNESS AND WIRE HARNESS (CONNECTOR LOCATION)
IE4	28	ENGINE ROOM MAIN WIRE AND COWL WIRE (LEFT KICK PANEL)
II2	30	LUGGAGE ROOM WIRE AND COWL WIRE (RIGHT KICK PANEL)
II3	30	COWL WIRE AND LUGGAGE ROOM WIRE (RIGHT KICK PANEL)

▽ : GROUND POINTS

CODE	SEE PAGE	GROUND POINTS LOCATION
IB	28	LEFT KICK PANEL
IC	28	INSTRUMENT PANEL BRACE LH
BF	32	FRONT LEFT FENDER

○ : SPLICE POINTS

CODE	SEE PAGE	WIRE HARNESS WITH SPLICE POINTS	CODE	SEE PAGE	WIRE HARNESS WITH SPLICE POINTS
B 3	32	LUGGAGE ROOM WIRE			

C15 BLACK

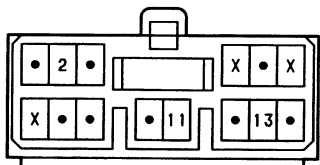

D10



F 3

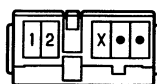

J 3

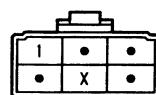

R20 (A) (C)

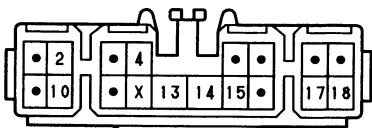

R21 (B)





SERVICE HINTS HEADLIGHT RELAY

⑤ 2- ⑤ 3: CLOSED WITH LIGHT CONTROL SW AT HEAD POSITION OR DIMMER SW AT FLASH POSITION

○ : PARTS LOCATION

CODE	SEE PAGE	CODE	SEE PAGE	CODE	SEE PAGE
C11	B 22	H 2	23	R20	B 23
C12	A 22	H 3	23	R22	23
C14	B 22	J 3	22	R23	23
C15	A 22	R20	A 23		

○ : RELAY BLOCKS

CODE	SEE PAGE	RELAY BLOCKS (RELAY BLOCK LOCATION)
5	17	R/B NO.5 (FRONT LUGGAGE COMPARTMENT RIGHT)

○ : JUNCTION BLOCK AND WIRE HARNESS CONNECTOR

CODE	SEE PAGE	JUNCTION BLOCK AND WIRE HARNESS (CONNECTOR LOCATION)
3C	19	COWL WIRE AND J/B NO.3 (BEHIND COMBINATION METER)
3D		

□ : CONNECTOR JOINING WIRE HARNESS AND WIRE HARNESS

CODE	SEE PAGE	JOINING WIRE HARNESS AND WIRE HARNESS (CONNECTOR LOCATION)
I12	30	LUGGAGE ROOM WIRE AND COWL WIRE (RIGHT KICK PANEL)

▽ : GROUND POINTS

CODE	SEE PAGE	GROUND POINTS LOCATION
IB	28	LEFT KICK PANEL
IC	28	INSTRUMENT PANEL BRACE LH
BE	32	FRONT RIGHT FENDER
BF	32	FRONT LEFT FENDER

○ : SPLICE POINTS

CODE	SEE PAGE	WIRE HARNESS WITH SPLICE POINTS	CODE	SEE PAGE	WIRE HARNESS WITH SPLICE POINTS
I 5	30	COWL WIRE	B 5	32	LUGGAGE ROOM WIRE
I10			B13		

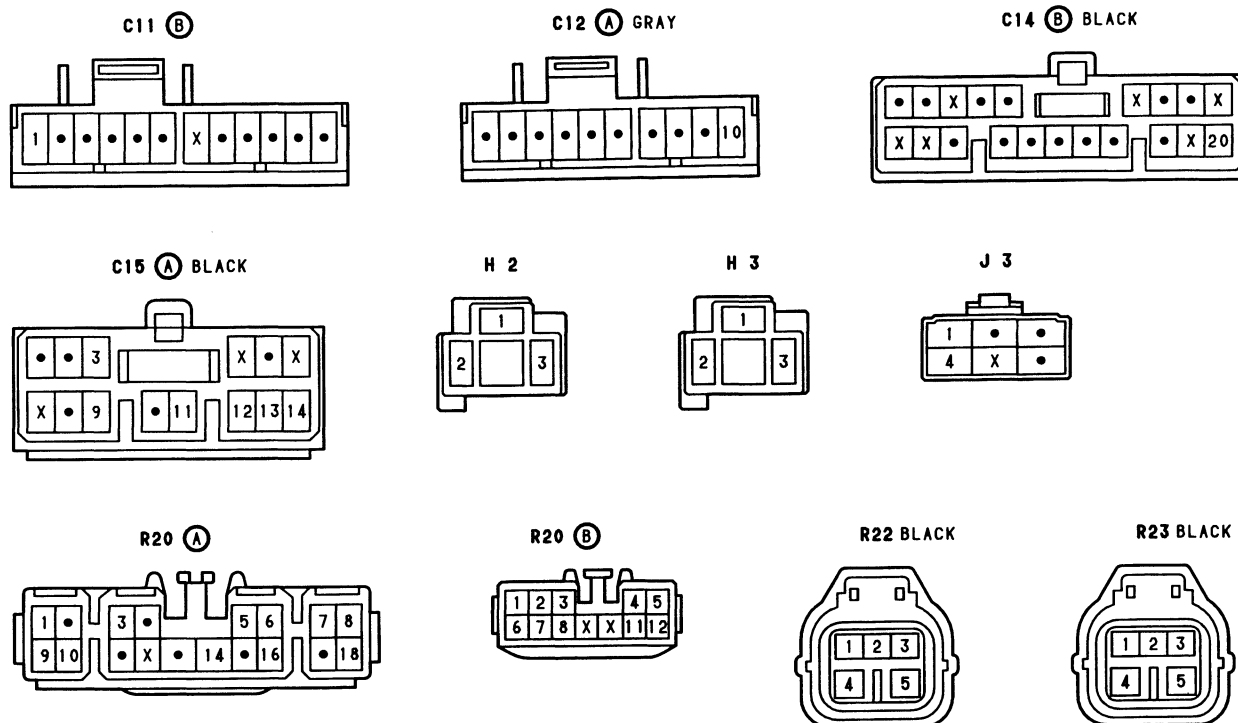



FOG LIGHT (FOR USA)

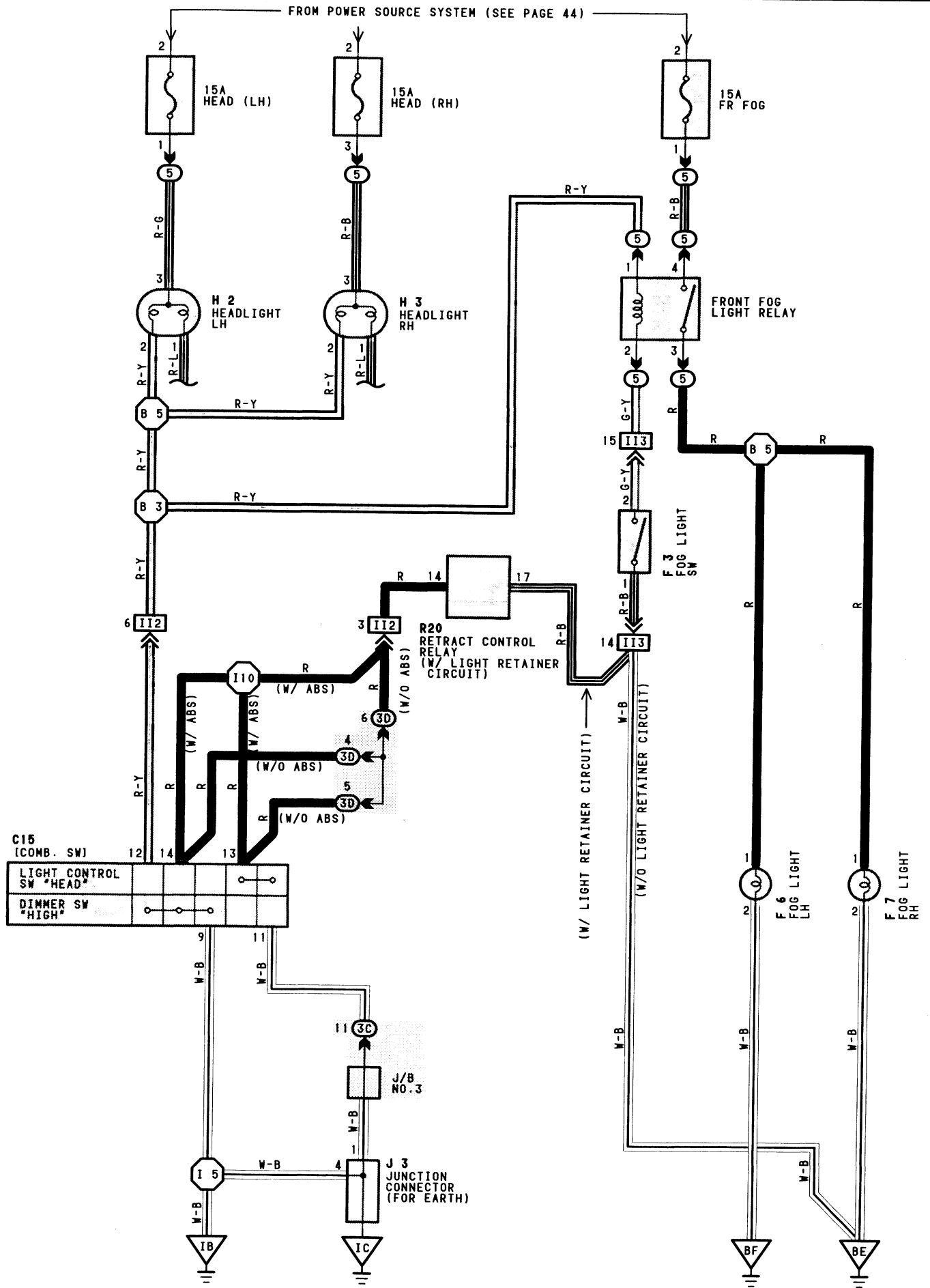

SERVICE HINTS

C15 DIMMER SW (COMB. SW)

9-12:CLOSED WITH DIMMER SW AT HIGH OR FLASH POSITION

FOG LIGHT RELAY

⑤ 4- ⑤ 3:CLOSED WITH LIGHT CONTROL SW AT HEAD POSITION, DIMMER SW AT LOW POSITION AND FOG LIGHT SW ON

○ : PARTS LOCATION

CODE	SEE PAGE	CODE	SEE PAGE	CODE	SEE PAGE
C15	22	F 7	23	J 3	22
F 3	22	H 2	23	R20	23
F 6	23	H 3	23		

○ : RELAY BLOCKS

CODE	SEE PAGE	RELAY BLOCKS (RELAY BLOCK LOCATION)
5	17	R/B NO.5 (FRONT LUGGAGE COMPARTMENT RIGHT)

○ : JUNCTION BLOCK AND WIRE HARNESS CONNECTOR

CODE	SEE PAGE	JUNCTION BLOCK AND WIRE HARNESS (CONNECTOR LOCATION)
3C	19	COWL WIRE AND J/B NO.3 (BEHIND COMBINATION METER)
3D		

□ : CONNECTOR JOINING WIRE HARNESS AND WIRE HARNESS

CODE	SEE PAGE	JOINING WIRE HARNESS AND WIRE HARNESS (CONNECTOR LOCATION)
I12	30	LUGGAGE ROOM WIRE AND COWL WIRE (RIGHT KICK PANEL)
I13	30	COWL WIRE AND LUGGAGE ROOM WIRE (RIGHT KICK PANEL)

▽ : GROUND POINTS

CODE	SEE PAGE	GROUND POINTS LOCATION
IB	28	LEFT KICK PANEL
IC	28	INSTRUMENT PANEL BRACE LH
BE	32	FRONT RIGHT FENDER
BF	32	FRONT LEFT FENDER

○ : SPLICE POINTS

CODE	SEE PAGE	WIRE HARNESS WITH SPLICE POINTS	CODE	SEE PAGE	WIRE HARNESS WITH SPLICE POINTS
I 5	30	COWL WIRE	B 3	32	LUGGAGE ROOM WIRE
I10			B 5		

C15 BLACK

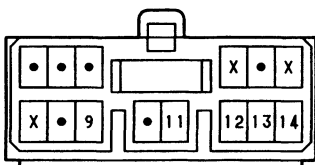

F 3

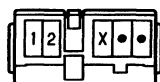

F 6, F 7



H 2, H 3

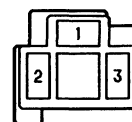

J 3

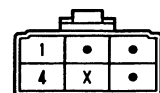

R20

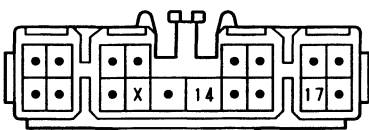



HEADLIGHT AND FOG LIGHT (FOR CANADA)

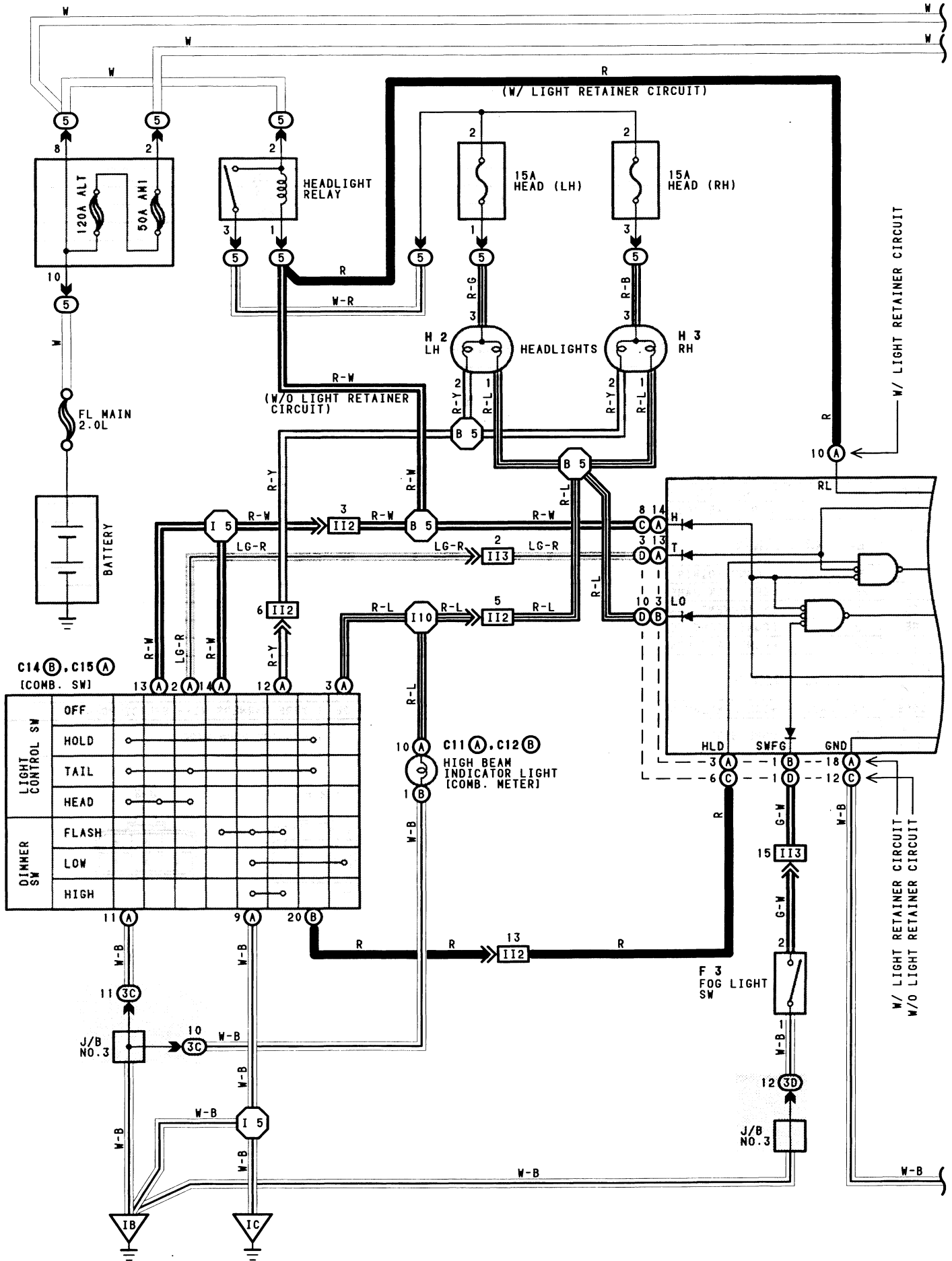

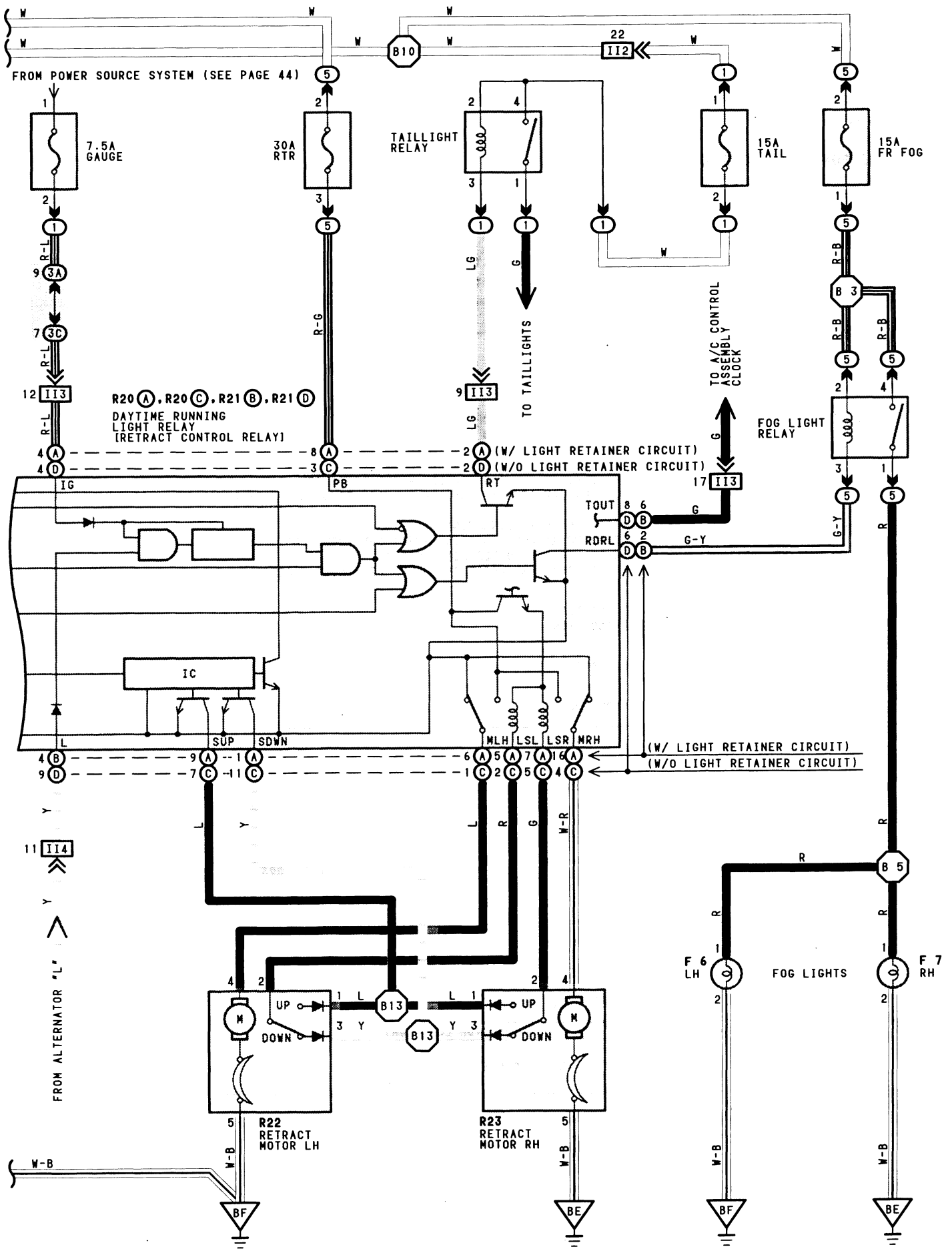



HEADLIGHT AND FOG LIGHT(FOR CANADA)

SYSTEM OUTLINE

CURRENT FROM THE BATTERY FLOWS CONTINUOUSLY FROM FL 2.0L → ALT FUSE → AM1 FUSE → TAILLIGHT RELAY (COIL SIDE)
 → TERMINAL RT OF THE RETRACT CONTROL RELAY, FL 2.0L → ALT FUSE → AM1 FUSE → FOGLIGHT RELAY (COIL SIDE)
 → TERMINAL RDRL OF RETRACT CONTROL RELAY.

WHEN THE IGNITION SW IS TURNED ON, THE CURRENT FLOWING THROUGH THE GAUGE FUSE FLOWS TO TERMINAL IG OF THE RETRACT CONTROL RELAY.

DAYTIME RUNNING LIGHT OPERATION

WHEN THE ENGINE IS STARTED, VOLTAGE IS GENERATED AT TERMINAL L OF THE ALTERNATOR AND VOLTAGE IS APPLIED TO TERMINAL L OF THE RETRACT CONTROL RELAY, CAUSING THE RETRACT CONTROL RELAY TO OPERATE SO THAT THE TAILLIGHT RELAY AND FOG LIGHT RELAY TURN ON. THIS CAUSES CURRENT TO FLOW FROM THE TAIL FUSE → TAILLIGHT RELAY (POINT SIDE) → EACH TAILLIGHT, AND FOG LIGHT RELAY (POINT SIDE) → FOG LIGHTS.

ACCORDINGLY, EVEN WHEN THE LIGHT CONTROL SW IS IN OFF POSITION, EACH OF THE LIGHTS JUST MENTIONED LIGHTS UP. THIS SYSTEM CONTINUES TO OPERATE UNTIL THE IGNITION SW IS TURNED OFF.

SERVICE HINTS

R20, R21 RETRACT CONTROL RELAY

RT, PB, RL-GROUND: ALWAYS APPROX. 12VOLTS

IG-GROUND: 0VOLTS WITH IGNITION SW AT LOCK OR ACC POSITION
 12VOLTS WITH IGNITION SW ON

HLD-GROUND: NO CONTINUITY WITH LIGHT CONTROL SW AT OFF OR HEAD POSITION
 CONTINUITY WITH LIGHT CONTROL SW AT HOLD OR TAIL POSITION

T-GROUND: NO CONTINUITY WITH LIGHT CONTROL SW AT OFF OR HOLD POSITION
 CONTINUITY WITH LIGHT CONTROL SW AT TAIL OR HEAD POSITION

H-GROUND: NO CONTINUITY WITH LIGHT CONTROL SW AT OFF, HOLD OR TAIL POSITION
 CONTINUITY WITH LIGHT CONTROL SW AT HEAD POSITION OR DIMMER SW AT FLASH POSITION

GND-GROUND: ALWAYS CONTINUITY

LSL-SDWN, LSR-SDWN: NO CONTINUITY WITH RETRACT MOTOR AT LOWERMOST POSITION

CONTINUITY WITH RETRACT MOTOR AT ANY POSITION EXCEPT LOWERMOST POSITION

LSR-SUP, LSL-SUP: NO CONTINUITY WITH RETRACT MOTOR AT UPPERMOST POSITION

CONTINUITY WITH RETRACT MOTOR AT ANY POSITION EXCEPT UPPERMOST POSITION

R22, R23 RETRACT MOTOR

2-3: OPEN WITH RETRACT MOTOR AT LOWERMOST POSITION

2-1: OPEN WITH RETRACT MOTOR AT UPPERMOST POSITION

LIGHT AUTO TURN OFF OPERATION

PLEASE REFER TO THE LIGHT AUTO TURN OFF SYSTEM (SEE PAGE 74)

C15 DIMMER SW (COMB. SW)

9-12: CLOSED WITH DIMMER SW AT HIGH OR FLASH POSITION

○ : PARTS LOCATION

CODE	SEE PAGE	CODE	SEE PAGE	CODE	SEE PAGE
C11	A 22	F 6	23	R20	C 23
C12	B 22	F 7	23	R21	B 23
C14	B 22	H 2	23		D 23
C15	A 22	H 3	23	R22	23
F 3	22	R20	A 23	R23	23

○ : RELAY BLOCKS

CODE	SEE PAGE	RELAY BLOCKS (RELAY BLOCK LOCATION)
1	18	R/B NO.1 (LEFT KICK PANEL)
5	17	R/B NO.5 (FRONT LUGGAGE COMPARTMENT RIGHT)

○ : JUNCTION BLOCK AND WIRE HARNESS CONNECTOR

CODE	SEE PAGE	JUNCTION BLOCK AND WIRE HARNESS (CONNECTOR LOCATION)
3A	19	COWL WIRE AND J/B NO.3 (BEHIND COMBINATION METER)
3C		
3D		

□ : CONNECTOR JOINING WIRE HARNESS AND WIRE HARNESS

CODE	SEE PAGE	JOINING WIRE HARNESS AND WIRE HARNESS (CONNECTOR LOCATION)
I12	30	LUGGAGE ROOM WIRE AND COWL WIRE (RIGHT KICK PANEL)
I13	30	COWL WIRE AND LUGGAGE ROOM WIRE (RIGHT KICK PANEL)
I14		

▽ : GROUND POINTS

CODE	SEE PAGE	GROUND POINTS LOCATION
IB	28	LEFT KICK PANEL
IC	28	INSTRUMENT PANEL BRACE LH
BE	32	FRONT RIGHT FENDER
BF	32	FRONT LEFT FENDER

○ : SPLICE POINTS

CODE	SEE PAGE	WIRE HARNESS WITH SPLICE POINTS	CODE	SEE PAGE	WIRE HARNESS WITH SPLICE POINTS
I 5	30	COWL WIRE	B 5	32	LUGGAGE ROOM WIRE
I10			B10		
B 3	32	LUGGAGE ROOM WIRE	B13		

C11 (A)

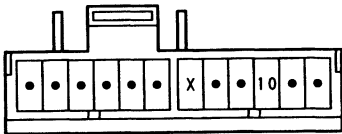

C12 (B) GRAY

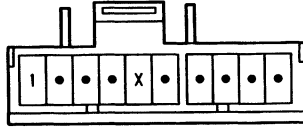

C14 (B) BLACK

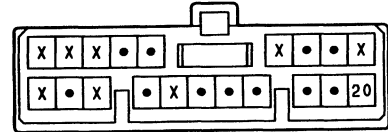

C15 (A) BLACK

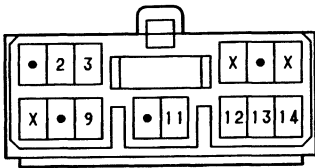

F 3

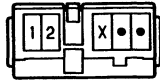

F 6, F 7



H 2, H 3

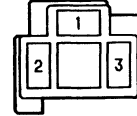

R20 (A)

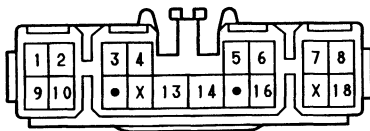

R20 (C)

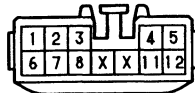

R21 (B)

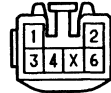

R21 (D)

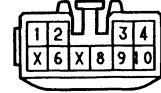

R22, R23 BLACK





TAILLIGHT

○ (W/ LIGHT RETAINER CIRCUIT)
△ (W/O LIGHT RETAINER CIRCUIT)

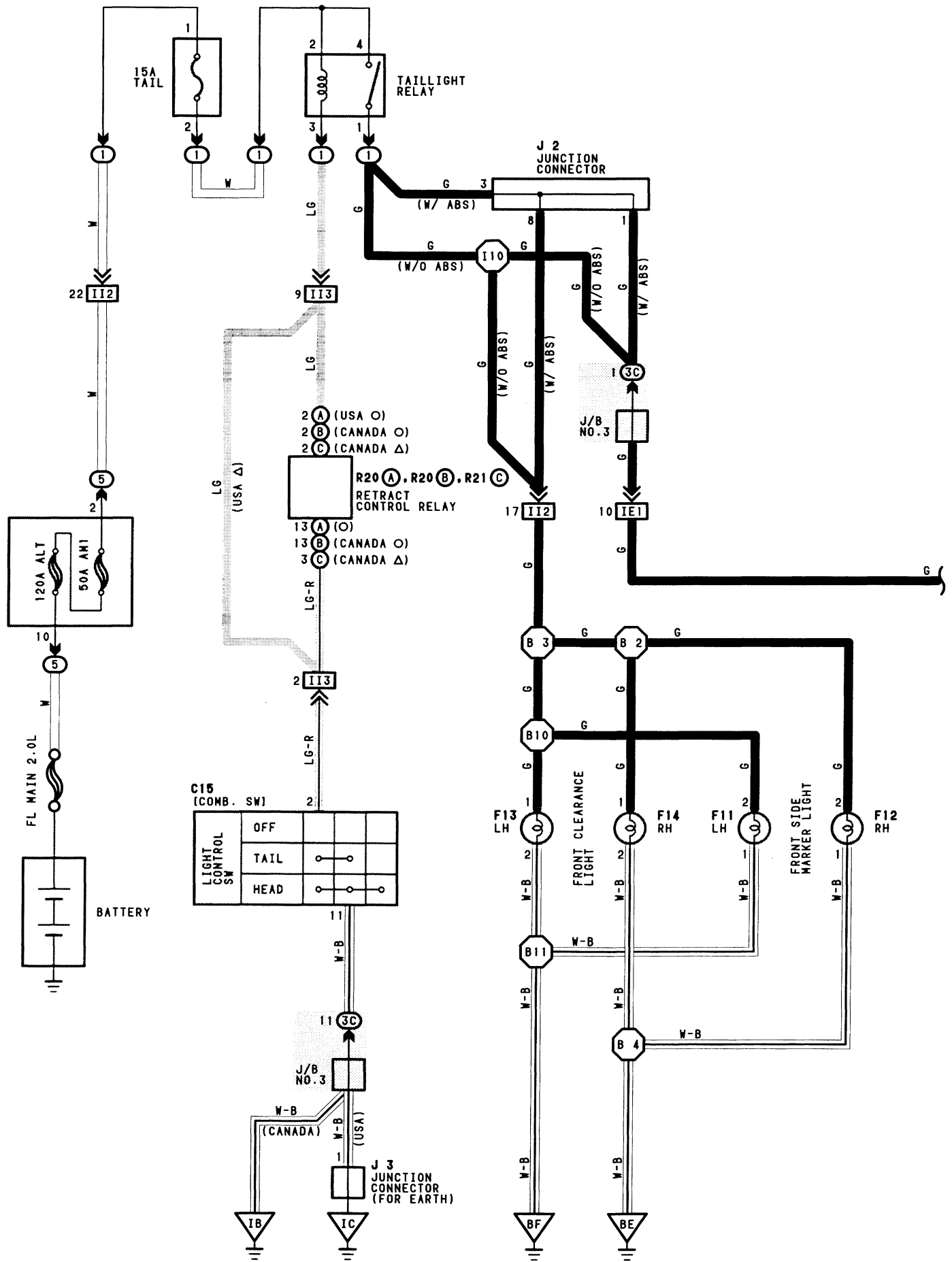

SERVICE HINTS
TAILLIGHT RELAY
 ① 4- ① 1: CLOSED WITH LIGHT CONTROL SW AT TAIL OR HEAD POSITION

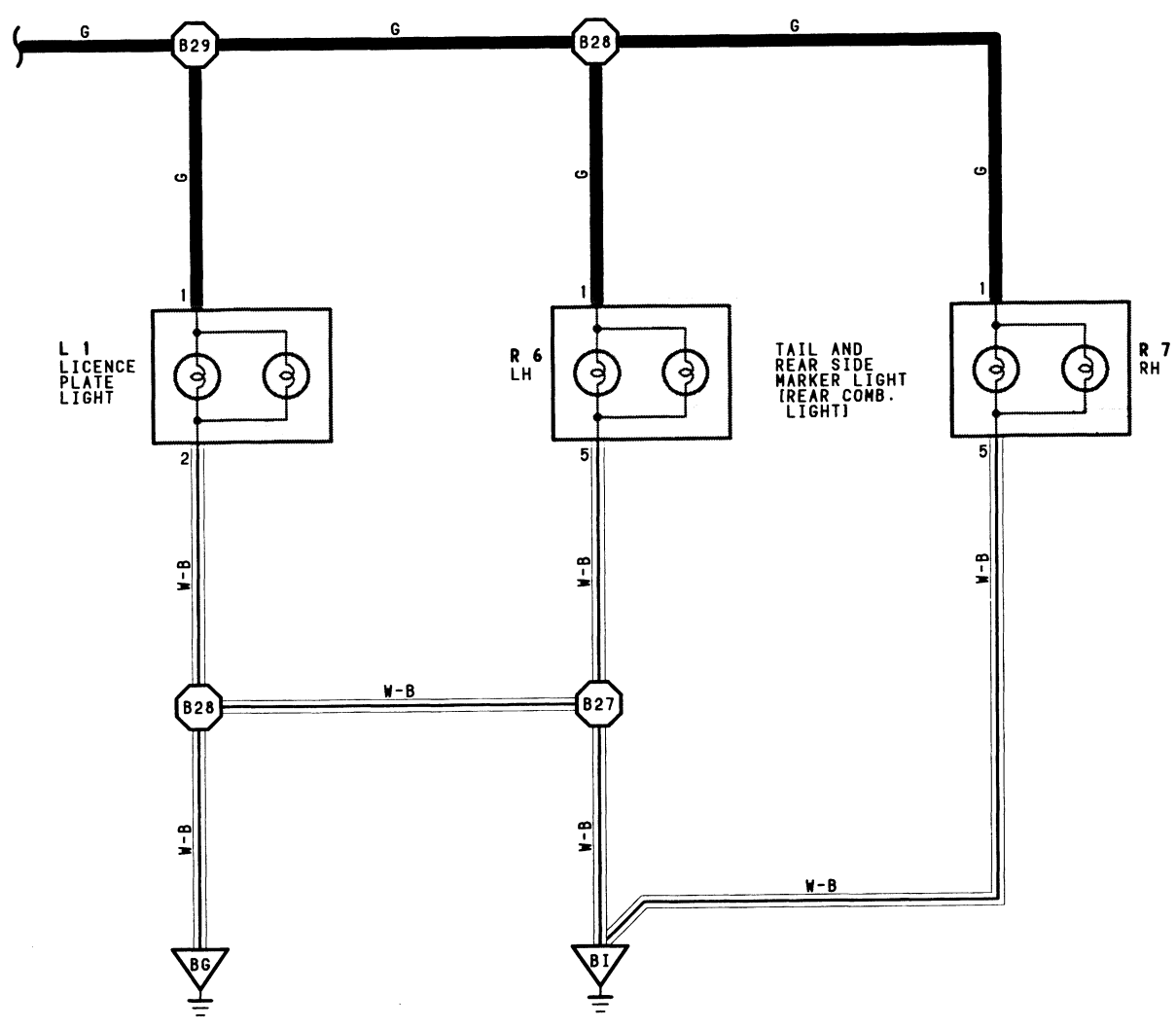



TAILLIGHT

○ : PARTS LOCATION

CODE	SEE PAGE	CODE	SEE PAGE	CODE	SEE PAGE
C15	22	J 2	22	R20	A 23
F11	23	J 3	22		B 23
F12	23	L 1	23	R21	C 23
F13	23	R 6	23		
F14	23	R 7	23		

○ : RELAY BLOCKS

CODE	SEE PAGE	RELAY BLOCKS (RELAY BLOCK LOCATION)
1	18	R/B NO.1 (LEFT KICK PANEL)
5	17	R/B NO.5 (FRONT LUGGAGE COMPARTMENT RIGHT)

○ : JUNCTION BLOCK AND WIRE HARNESS CONNECTOR

CODE	SEE PAGE	JUNCTION BLOCK AND WIRE HARNESS (CONNECTOR LOCATION)
3C	19	COWL WIRE AND J/B NO.3 (BEHIND COMBINATION METER)

□ : CONNECTOR JOINING WIRE HARNESS AND WIRE HARNESS

CODE	SEE PAGE	JOINING WIRE HARNESS AND WIRE HARNESS (CONNECTOR LOCATION)
IE1	28	ENGINE ROOM MAIN WIRE AND COWL WIRE (LEFT KICK PANEL)
II2	30	LUGGAGE ROOM WIRE AND COWL WIRE (RIGHT KICK PANEL)
II3	30	COWL WIRE AND LUGGAGE ROOM WIRE (RIGHT KICK PANEL)

▽ : GROUND POINTS

CODE	SEE PAGE	GROUND POINTS LOCATION
IB	28	LEFT KICK PANEL
IC	28	INSTRUMENT PANEL BRACE LH
BE	32	FRONT RIGHT FENDER
BF	32	FRONT LEFT FENDER
BG	32	UNDER THE LEFT CENTER PILLAR
BI	32	BACK PANEL CENTER

○ : SPLICE POINTS

CODE	SEE PAGE	WIRE HARNESS WITH SPLICE POINTS	CODE	SEE PAGE	WIRE HARNESS WITH SPLICE POINTS
I10	30	COWL WIRE	B11	32	LUGGAGE ROOM WIRE
B 2	32	LUGGAGE ROOM WIRE	B27	32	ENGINE ROOM MAIN WIRE
B 3			B28		
B 4			B29		
B10					

C15 BLACK

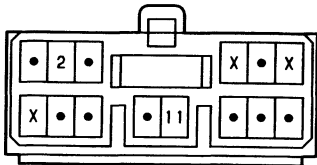

F11



F12



F13



F14



J 2

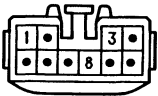

J 3

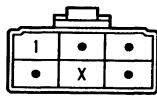

L 1



R 6

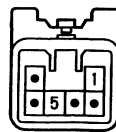

R 7

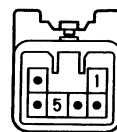

R20 (A)

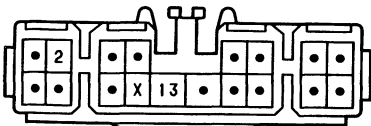

R20 (B)

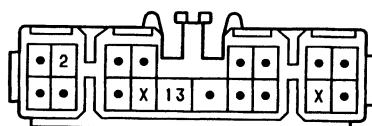

R21 (C)

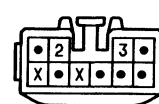

○ : PARTS LOCATION

CODE		SEE PAGE	CODE		SEE PAGE	CODE		SEE PAGE
A10	B	22	F 3	22	R 2	B	22	
A12	A	22	H 1	22	R 3	C	22	
A19		22	J 1	22	R 4		22	
C 7		22	J 2	22	R20	A	23	
C11		22	J 3	22	R21	B	23	
C15		22	R 1	A				

○ : RELAY BLOCKS

CODE	SEE PAGE	RELAY BLOCKS (RELAY BLOCK LOCATION)
1	18	R/B NO.1 (LEFT KICK PANEL)
5	17	R/B NO.5 (FRONT LUGGAGE COMPARTMENT RIGHT)

○ : JUNCTION BLOCK AND WIRE HARNESS CONNECTOR

CODE	SEE PAGE	JUNCTION BLOCK AND WIRE HARNESS (CONNECTOR LOCATION)
3A	19	COWL WIRE AND J/B NO.3 (BEHIND COMBINATION METER)
3C		
3D		

□ : CONNECTOR JOINING WIRE HARNESS AND WIRE HARNESS

CODE	SEE PAGE	JOINING WIRE HARNESS AND WIRE HARNESS (CONNECTOR LOCATION)
I12	30	LUGGAGE ROOM WIRE AND COWL WIRE (RIGHT KICK PANEL)
I13	30	COWL WIRE AND LUGGAGE ROOM WIRE (RIGHT KICK PANEL)

▽ : GROUND POINTS

CODE	SEE PAGE	GROUND POINTS LOCATION
IB	28	LEFT KICK PANEL
IC	28	INSTRUMENT PANEL BRACE LH

○ : SPLICE POINTS

CODE	SEE PAGE	WIRE HARNESS WITH SPLICE POINTS	CODE	SEE PAGE	WIRE HARNESS WITH SPLICE POINTS
I 2	30	COWL WIRE	I10	30	COWL WIRE
I 7					
I 9					

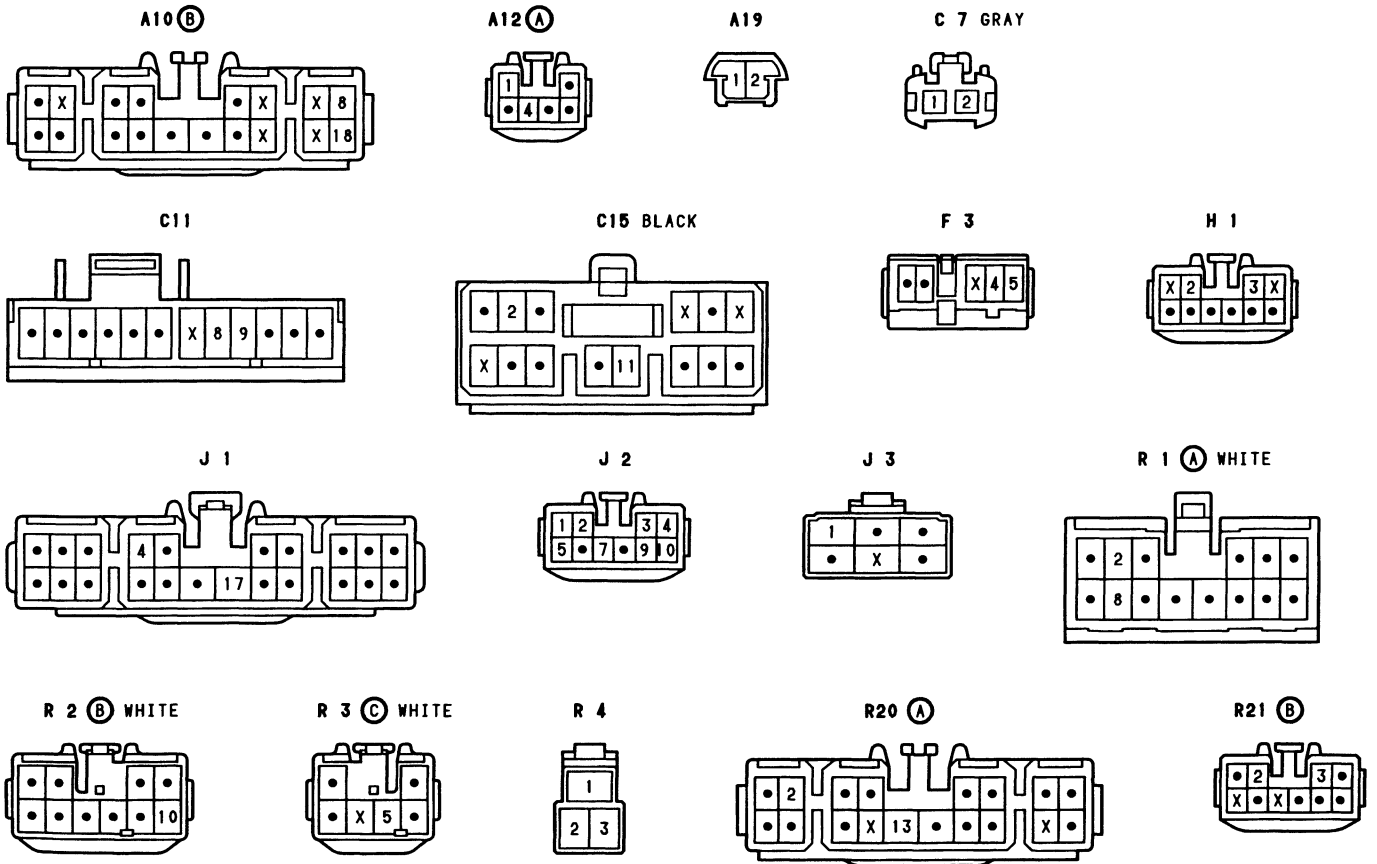



ILLUMINATION

○ W/ LIGHT RETAINER CIRCUIT
△ W/O LIGHT RETAINER CIRCUIT

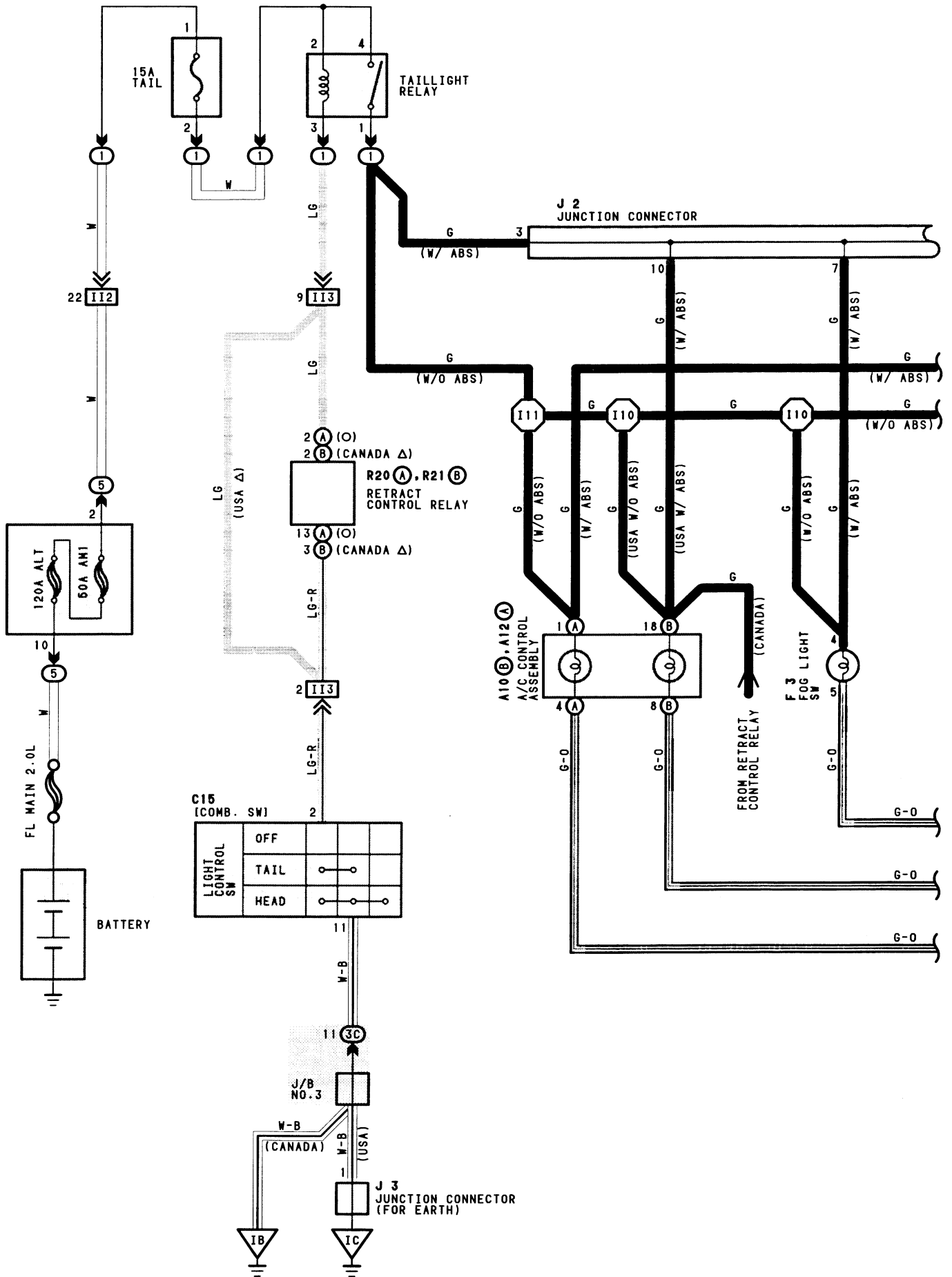

SERVICE HINTS

TAILLIGHT RELAY

① 4-① 1: CLOSED WITH LIGHT CONTROL SW AT TAIL OR HEAD POSITION (WHEN LIGHT AUTO TURN OFF SYSTEM IS OFF)

R 4 RHEOSTAT

1-2: APPROX. 12VOLTS WITH RHEOSTAT FULLY TURNED COUNTERCLOCKWISE AND 0VOLTS WITH FULLY TURNED CLOCKWISE

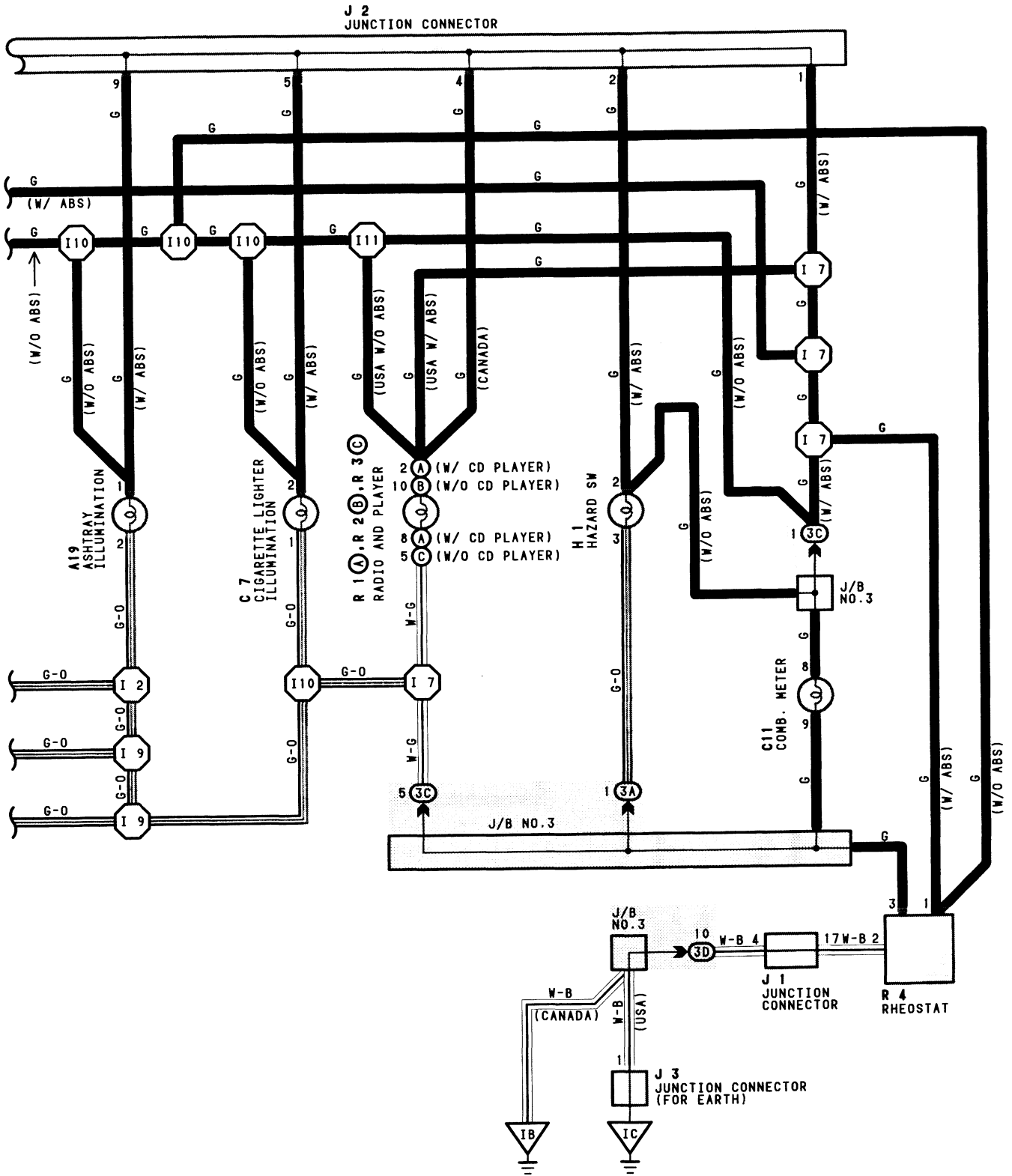



INTERIOR LIGHT

○ W/ DOOR KEY CYLINDER LIGHT
△ W/O DOOR KEY CYLINDER LIGHT

FROM POWER SOURCE SYSTEM (SEE PAGE 44)

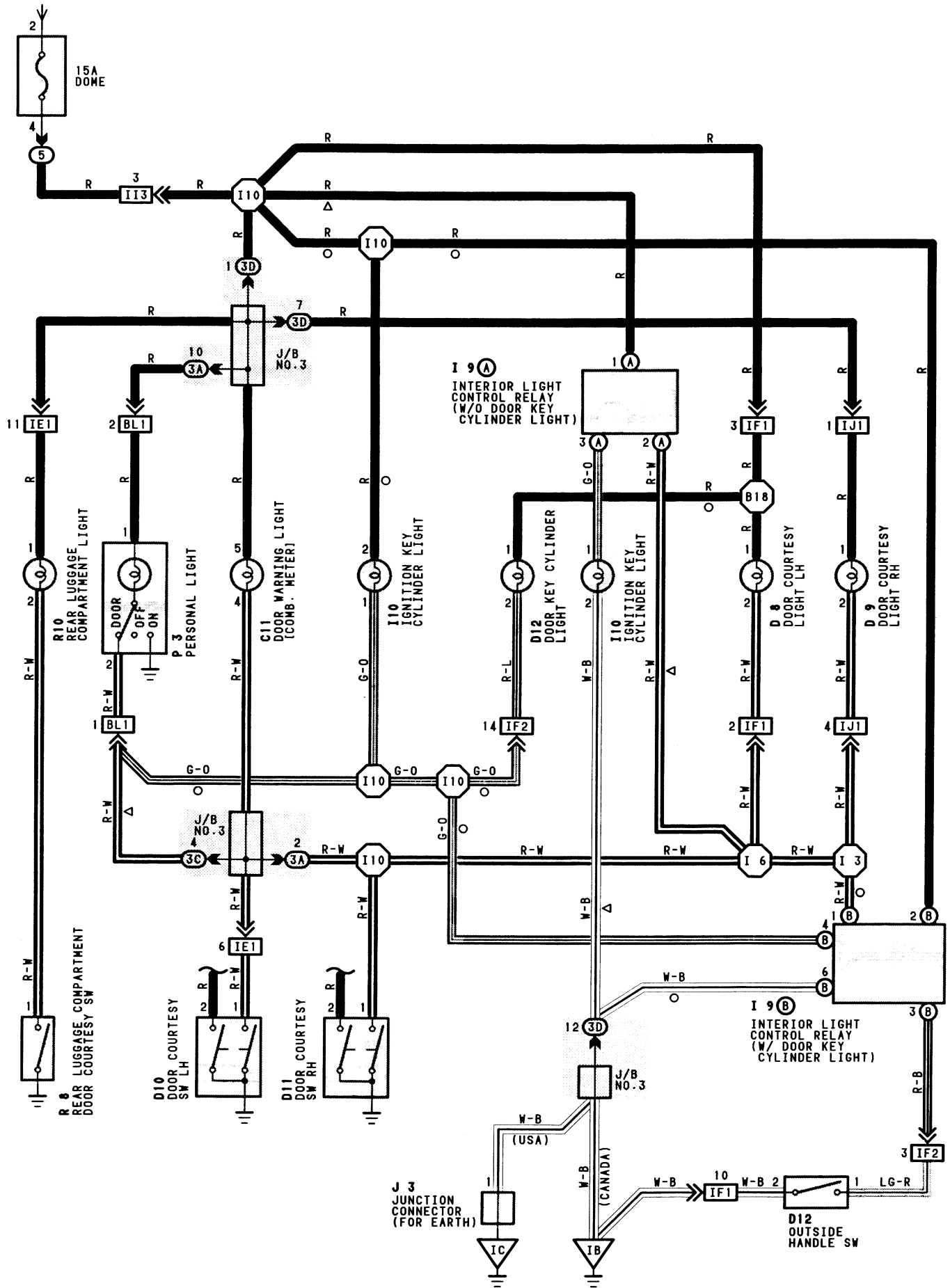

SERVICE HINTS

D10 DOOR COURTESY SW LH

1-GROUND:CLOSED WITH DRIVER'S DOOR OPEN

D11 DOOR COURTESY SW RH

1-GROUND:CLOSED WITH PASSENGER'S DOOR OPEN

R 8 REAR LUGGAGE COMPARTMENT DOOR COURTESY SW

1-GROUND:CLOSED WITH REAR LUGGAGE COMPARTMENT DOOR OPEN

○ : PARTS LOCATION

CODE	SEE PAGE	CODE	SEE PAGE	CODE	SEE PAGE
C11	22	D11	23	J 3	22
D 8	23	D12	23	P 3	23
D 9	23	I 9	22	R 8	23
D10	23	I10	22	R10	23

○ : RELAY BLOCKS

CODE	SEE PAGE	RELAY BLOCKS (RELAY BLOCK LOCATION)
5	17	R/B NO.5 (FRONT LUGGAGE COMPARTMENT RIGHT)

○ : JUNCTION BLOCK AND WIRE HARNESS CONNECTOR

CODE	SEE PAGE	JUNCTION BLOCK AND WIRE HARNESS (CONNECTOR LOCATION)
3A	19	COWL WIRE AND J/B NO.3 (BEHIND COMBINATION METER)
3C		
3D		

□ : CONNECTOR JOINING WIRE HARNESS AND WIRE HARNESS

CODE	SEE PAGE	JOINING WIRE HARNESS AND WIRE HARNESS (CONNECTOR LOCATION)
IE1	28	ENGINE ROOM MAIN WIRE AND COWL WIRE (LEFT KICK PANEL)
IF1	28	COWL WIRE AND FRONT DOOR LH WIRE (LEFT KICK PANEL)
IF2	28	FRONT DOOR LH WIRE AND COWL WIRE (LEFT KICK PANEL)
I13	30	COWL WIRE AND LUGGAGE ROOM WIRE (RIGHT KICK PANEL)
IJ1	30	COWL WIRE AND FRONT DOOR RH WIRE (RIGHT KICK PANEL)
BL1	32	ROOF WIRE AND COWL WIRE (UNDER THE RIGHT FRONT PILLAR)

▽ : GROUND POINTS

CODE	SEE PAGE	GROUND POINTS LOCATION
IB	28	LEFT KICK PANEL
IC	28	INSTRUMENT PANEL BRACE LH

○ : SPLICE POINTS

CODE	SEE PAGE	WIRE HARNESS WITH SPLICE POINTS	CODE	SEE PAGE	WIRE HARNESS WITH SPLICE POINTS
I 3	30	COWL WIRE	I10	30	COWL WIRE
I 6			B18	32	FRONT DOOR LH WIRE

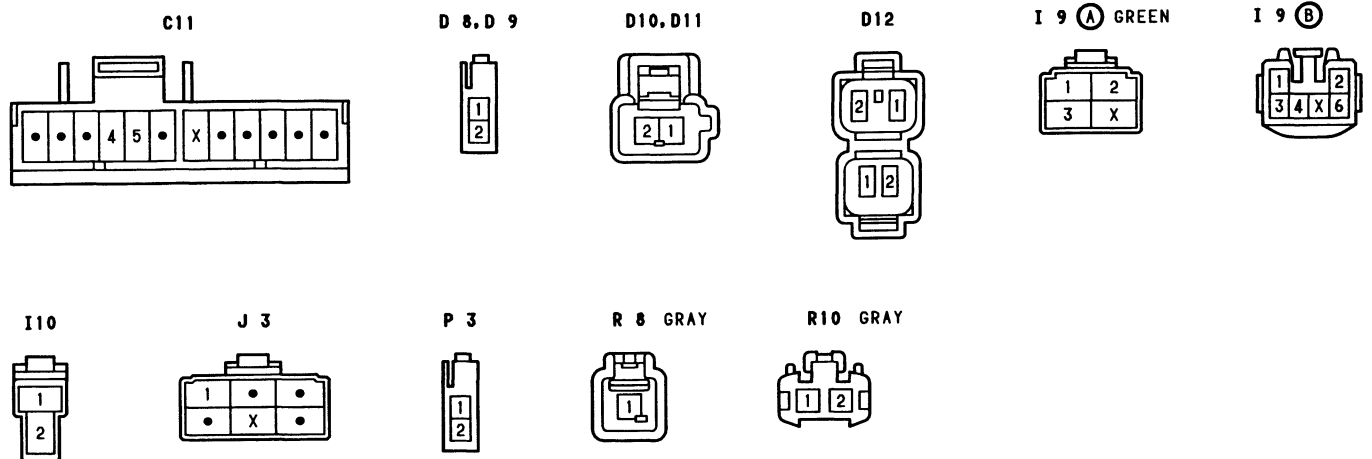



TURN SIGNAL AND HAZARD WARNING LIGHT

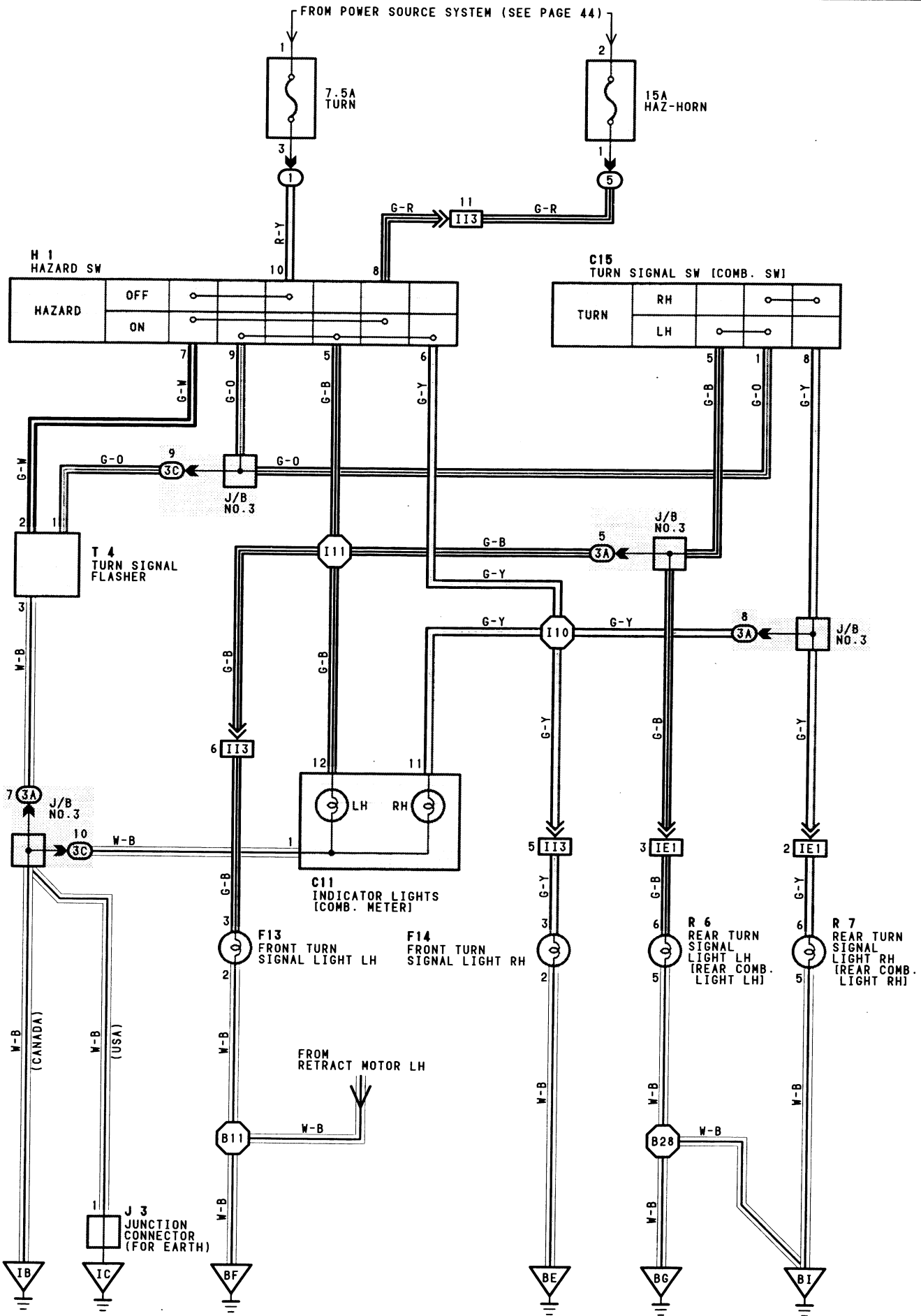

SERVICE HINTS

T 4 TURN SIGNAL FLASHER

2-GROUND: APPROX. 12VOLTS WITH IGNITION SW ON OR HAZARD SW ON

1-GROUND: CHANGES FROM 12 TO 0VOLTS WITH IGNITION SW ON AND TURN SIGNAL SW LEFT OR RIGHT, OR WITH HAZARD SW ON

3-GROUND: ALWAYS CONTINUITY

○ : PARTS LOCATION

CODE	SEE PAGE	CODE	SEE PAGE	CODE	SEE PAGE
C11	22	F14	23	R 6	23
C15	22	H 1	22	R 7	23
F13	23	J 3	22	T 4	22

○ : RELAY BLOCKS

CODE	SEE PAGE	RELAY BLOCKS (RELAY BLOCK LOCATION)
1	18	R/B NO.1 (LEFT KICK PANEL)
5	17	R/B NO.5 (FRONT LUGGAGE COMPARTMENT RIGHT)

○ : JUNCTION BLOCK AND WIRE HARNESS CONNECTOR

CODE	SEE PAGE	JUNCTION BLOCK AND WIRE HARNESS (CONNECTOR LOCATION)
3A	19	COWL WIRE AND J/B NO.3 (BEHIND COMBINATION METER)
3C		

□ : CONNECTOR JOINING WIRE HARNESS AND WIRE HARNESS

CODE	SEE PAGE	JOINING WIRE HARNESS AND WIRE HARNESS (CONNECTOR LOCATION)
IE1	28	ENGINE ROOM MAIN WIRE AND COWL WIRE (LEFT KICK PANEL)
I13	30	COWL WIRE AND LUGGAGE ROOM WIRE (RIGHT KICK PANEL)

▽ : GROUND POINTS

CODE	SEE PAGE	GROUND POINTS LOCATION
IB	28	LEFT KICK PANEL
IC	28	INSTRUMENT PANEL BRACE LH
BE	32	FRONT RIGHT FENDER
BF	32	FRONT LEFT FENDER
BG	32	UNDER THE LEFT CENTER PILLAR
BI	32	BACK PANEL CENTER

○ : SPLICE POINTS

CODE	SEE PAGE	WIRE HARNESS WITH SPLICE POINTS	CODE	SEE PAGE	WIRE HARNESS WITH SPLICE POINTS
I10	30	COWL WIRE	B11	32	LUGGAGE ROOM WIRE
I11			B28	32	ENGINE ROOM MAIN WIRE

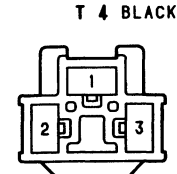
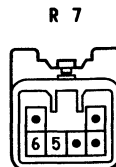
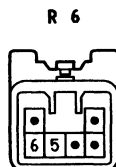
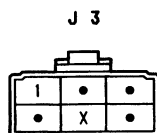
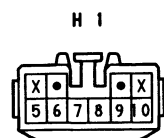
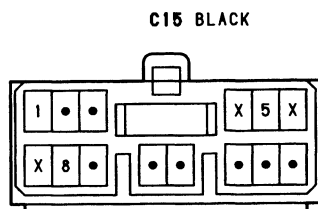
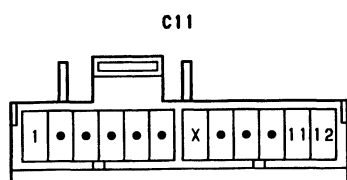



BACK-UP LIGHT

FROM POWER SOURCE SYSTEM (SEE PAGE 44)

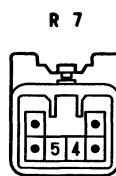
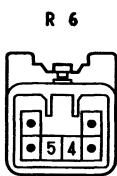
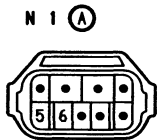
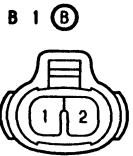
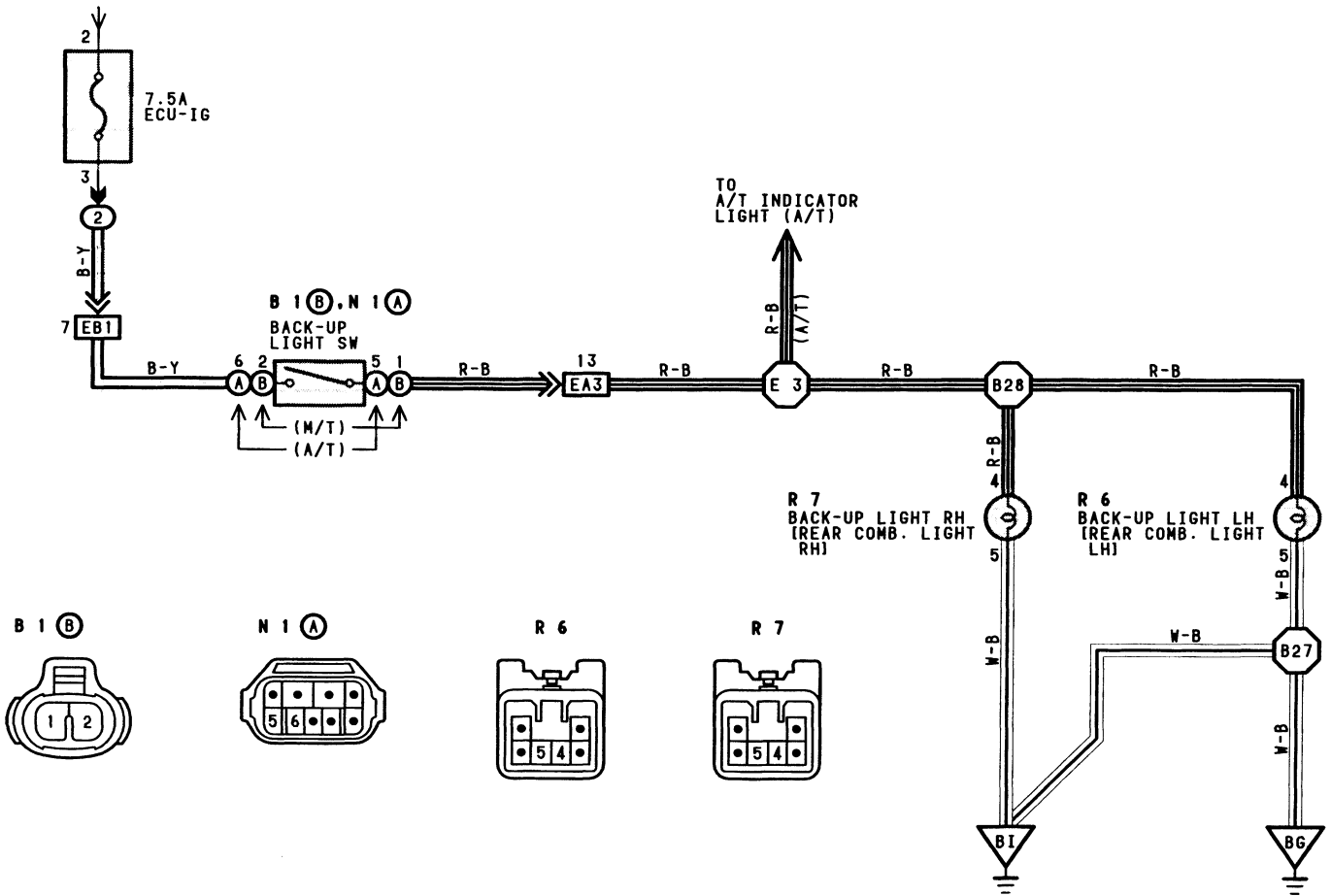

SERVICE HINTS

B 1 (B), N 1 (A) BACK-UP LIGHT SW

(A) 6-5, (B) 2-1: CLOSED WITH SHIFT LEVER IN R POSITION

○ : PARTS LOCATION

CODE	SEE PAGE	CODE	SEE PAGE	CODE	SEE PAGE
B 1	B	20(5S-FE), 21(3S-GTE)		R 6	23
N 1	A	20(5S-FE)		R 7	23

○ : RELAY BLOCKS

CODE	SEE PAGE	RELAY BLOCKS (RELAY BLOCK LOCATION)
2	18	R/B NO.2 (ENGINE COMPARTMENT LEFT)

□ : CONNECTOR JOINING WIRE HARNESS AND WIRE HARNESS

CODE	SEE PAGE	JOINING WIRE HARNESS AND WIRE HARNESS (CONNECTOR LOCATION)
EA3	24(5S-FE)	ENGINE ROOM MAIN WIRE AND ENGINE WIRE (R/B NO.2 INNER)
	26(3S-GTE)	
EB1	24(5S-FE)	ENGINE WIRE AND R/B NO.2 (R/B NO.2 INNER)
	26(3S-GTE)	

▽ : GROUND POINTS

CODE	SEE PAGE	GROUND POINTS LOCATION
B6	32	UNDER THE LEFT CENTER PILLAR
BI	32	BACK PANEL CENTER

○ : SPLICE POINTS

CODE	SEE PAGE	WIRE HARNESS WITH SPLICE POINTS	CODE	SEE PAGE	WIRE HARNESS WITH SPLICE POINTS
E 3	24(5S-FE)	ENGINE ROOM MAIN WIRE	B27	32	ENGINE ROOM MAIN WIRE
	26(3S-GTE)		B28		

STOP LIGHT



FROM POWER SOURCE SYSTEM (SEE PAGE 44)

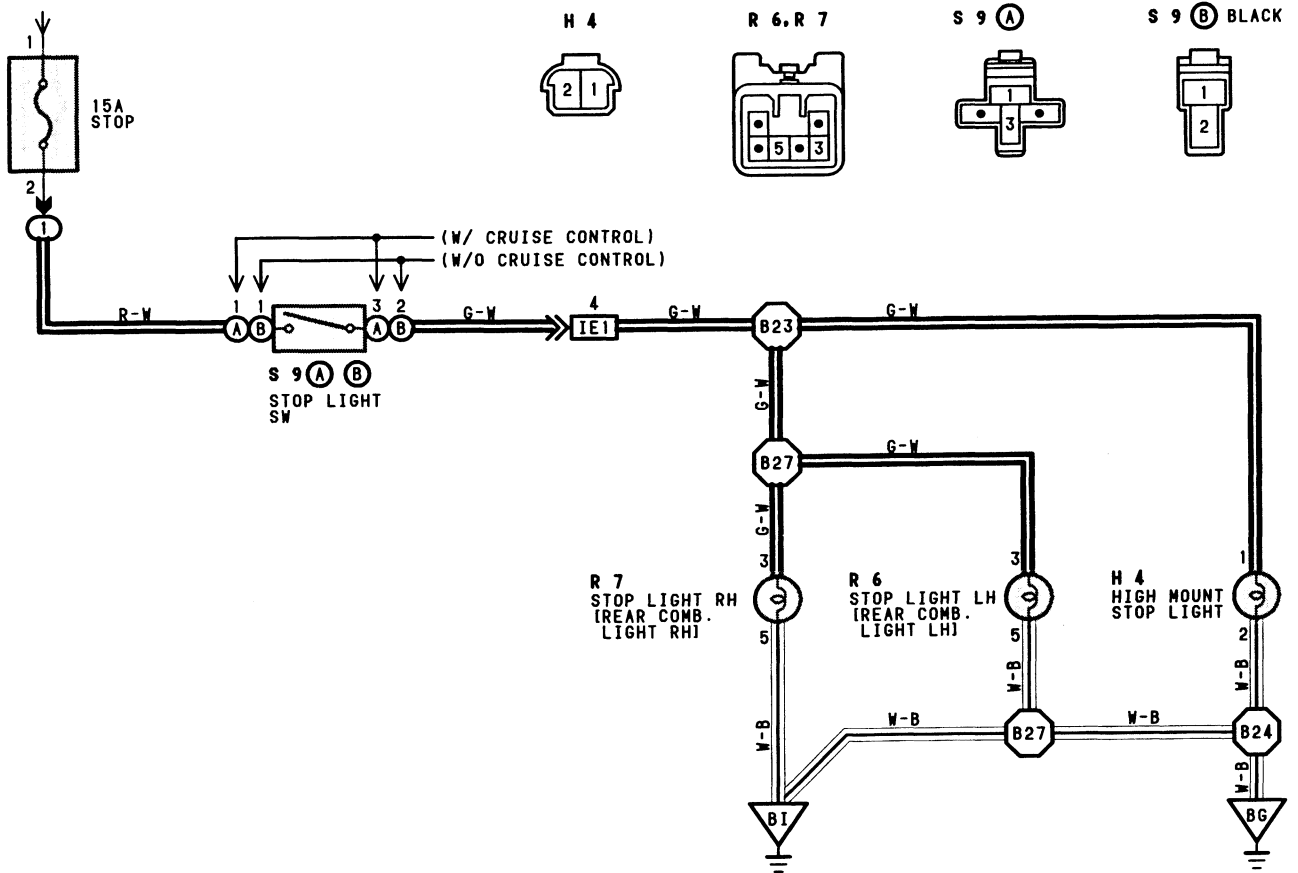

SERVICE HINTS

S 9 STOP LIGHT SW

- (A) 1-(A) 3: CLOSED WITH BRAKE PEDAL DEPRESSED (W/ CRUISE CONTROL)
- (B) 1-(B) 2: CLOSED WITH BRAKE PEDAL DEPRESSED (W/O CRUISE CONTROL)

○ : PARTS LOCATION

CODE	SEE PAGE	CODE	SEE PAGE	CODE	SEE PAGE
H 4	23	R 7	23	S 9	B
R 6	23	S 9	A		22

○ : RELAY BLOCKS

CODE	SEE PAGE	RELAY BLOCKS (RELAY BLOCK LOCATION)
I	18	R/B NO.1 (LEFT KICK PANEL)

□ : CONNECTOR JOINING WIRE HARNESS AND WIRE HARNESS

CODE	SEE PAGE	JOINING WIRE HARNESS AND WIRE HARNESS (CONNECTOR LOCATION)
IE1	28	ENGINE ROOM MAIN WIRE AND COWL WIRE (LEFT KICK PANEL)

▽ : GROUND POINTS

CODE	SEE PAGE	GROUND POINTS LOCATION
BG	32	UNDER THE LEFT CENTER PILLAR
BI	32	BACK PANEL CENTER

○ : SPLICE POINTS

CODE	SEE PAGE	WIRE HARNESS WITH SPLICE POINTS	CODE	SEE PAGE	WIRE HARNESS WITH SPLICE POINTS
B23	32	ENGINE ROOM MAIN WIRE	B27	32	ENGINE ROOM MAIN WIRE
B24					

SYSTEM OUTLINE

CURRENT ALWAYS FLOWS TERMINAL 2 OF THE POWER MAIN RELAY THROUGH THE POWER FUSE. WITH THE IGNITION SW TURNED ON, CURRENT FLOWS THROUGH THE GAUGE FUSE TO TERMINAL 3 OF THE POWER MAIN RELAY → TERMINAL 1 → TO GROUND. THIS ACTIVATES THE RELAY AND CURRENT FLOWING TO TERMINAL 4 OF THE POWER MAIN RELAY → TO TERMINAL 9 OF THE POWER WINDOW MASTER SW AND TERMINAL 5 OF THE POWER WINDOW SW RH (PASSENGER'S).

1. MANUAL OPERATION (DRIVER'S WINDOW)

WITH THE IGNITION SW TURNED ON AND WITH THE POWER WINDOW MASTER SW IN UP POSITION, THE CURRENT FLOWING TO TERMINAL 9 OF THE POWER WINDOW MASTER SW FLOWS TO TERMINAL 3 OF THE MASTER SW → TERMINAL 2 OF THE POWER WINDOW MOTOR LH (DRIVER'S) → MOTOR → TERMINAL 1 → TERMINAL 4 OF THE MASTER SW → TERMINAL 6 → TO GROUND AND CAUSES THE POWER WINDOW MOTOR TO ROTATE IN THE UP DIRECTION. THE WINDOW ASCENDS ONLY WHILE THE SW IS BEING PUSHED. IN DOWN OPERATION, THE FLOW OF CURRENT FROM TERMINAL 9 OF THE POWER WINDOW MASTER SW TO TERMINAL 4 OF THE MASTER SW CAUSES THE FLOW OF CURRENT FROM TERMINAL 1 OF THE MOTOR → MOTOR → TERMINAL 2 → TERMINAL 3 OF THE MASTER SW → TERMINAL 6 → TO GROUND, FLOWING IN THE OPPOSITE DIRECTION TO MANUAL UP OPERATION AND CAUSING THE MOTOR TO ROTATE IN REVERSE, LOWERING THE WINDOW.

2. AUTO DOWN OPERATION

WITH THE IGNITION SW ON AND WITH THE DRIVER'S SW OF THE POWER WINDOW MASTER SW IN DOWN POSITION, CURRENT FLOWING TO TERMINAL 9 OF THE MASTER SW FLOWS TO TERMINAL 4 OF THE MASTER SW → TERMINAL 1 OF THE POWER WINDOW MOTOR → MOTOR → TERMINAL 2 → TERMINAL 3 OF THE MASTER SW → TERMINAL 6 → TO GROUND, CAUSING THE MOTOR TO ROTATE TOWARDS THE DOWN SIDE. THEN THE SOLENOID IN THE MASTER SW IS ACTIVATED AND IT LOCKS THE DRIVER'S SW BEING PUSHED, CAUSING THE MOTOR TO CONTINUE TO ROTATE IN AUTO DOWN OPERATION.

WHEN THE WINDOW HAS COMPLETELY DESCENDED, THE CURRENT FLOW BETWEEN TERMINAL 3 OF THE MASTER SW AND TERMINAL 6 INCREASES. AS A RESULT, THE SOLENOID STOPS OPERATING, THE DRIVER'S SW TURNS OFF AND FLOW FROM TERMINAL 9 OF THE MASTER SW TO TERMINAL 4 IS CUT OFF, STOPPING THE MOTOR SO THAT AUTO STOP OCCURS.

3. STOPPING OF AUTO DOWN AT DRIVER'S WINDOW

WHEN THE DRIVER'S SW IS PULLED TO THE UP SIDE DURING AUTO DOWN OPERATION, A GROUND CIRCUIT OPENS IN THE MASTER SW AND CURRENT DOES NOT FLOW FROM TERMINAL 3 OF THE MASTER SW → TO TERMINAL 6, SO THE MOTOR STOPS, CAUSING AUTO DOWN OPERATION TO STOP. IF THE DRIVER'S SW IS PUSHED CONTINUOUSLY, THE MOTOR ROTATES IN THE UP DIRECTION IN MANUAL UP OPERATION.

4. MANUAL OPERATION BY POWER WINDOW SW (PASSENGER'S WINDOW)

WITH POWER WINDOW SW (PASSENGER'S) PULLED TO THE UP SIDE, CURRENT FLOWING FROM TERMINAL 5 OF THE POWER WINDOW SW FLOWS TO TERMINAL 1 OF THE POWER WINDOW SW → TERMINAL 2 OF THE WINDOW MOTOR → MOTOR → TERMINAL 1 → TERMINAL 4 OF THE POWER WINDOW SW → TERMINAL 2 → TERMINAL 10 OF THE MASTER SW → TERMINAL 6 → TO GROUND AND CAUSES THE POWER WINDOW MOTOR (PASSENGER'S) TO ROTATE IN THE UP DIRECTION. UP OPERATION CONTINUES ONLY WHILE THE POWER WINDOW SW IS PULLED TO THE UP SIDE. WHEN THE WINDOW DESCENDS, THE CURRENT FLOWING TO THE MOTOR FLOWS IN THE OPPOSITE DIRECTION, FROM TERMINAL 1 → MOTOR → TO TERMINAL 2, AND THE MOTOR ROTATES IN REVERSE. WHEN THE WINDOW LOCK SW IS PUSHED TO THE LOCK SIDE, THE GROUND CIRCUIT TO THE PASSENGER'S WINDOW BECOMES OPEN.

AS A RESULT, EVEN IF OPEN/CLOSE OPERATION OF THE PASSENGER'S WINDOW IS TRIED, THE CURRENT FROM TERMINAL 9 OF THE POWER WINDOW MASTER SW IS NOT GROUNDED AND THE MOTOR DOES NOT ROTATE, SO THE PASSENGER'S WINDOW CAN NOT BE OPERATED AND WINDOW LOCK OCCURS.

5. KEY OFF POWER WINDOW OPERATION

WITH THE IGNITION SW TURNED FROM ON TO OFF, THE DOOR LOCK ECU OPERATES AND CURRENT FLOWS FROM POWER FUSE → TERMINAL 8 OF THE DOOR LOCK ECU → TERMINAL 15 → TERMINAL 3 OF THE POWER MAIN RELAY → TERMINAL 1 → TO GROUND FOR ABOUT 60 SECONDS. THE SAME AS NORMAL OPERATION, THE CURRENT FLOWS FROM POWER FUSE → TERMINAL 2 OF THE POWER MAIN RELAY → TERMINAL 4 → TERMINAL 9 OF THE POWER WINDOW MASTER SW AND TERMINAL 5 OF POWER WINDOW SW RH (PASSENGER'S). AS A RESULT, FOR ABOUT 60 SECONDS AFTER THE IGNITION SW IS TURNED OFF, IT IS POSSIBLE TO RAISE AND LOWER THE POWER WINDOW BY THE FUNCTIONING OF THIS RELAY. ALSO, BY OPENING THE DOOR (DOOR COURTESY SW ON) WITHIN ABOUT 60 SECONDS AFTER TURNING THE IGNITION SW TO OFF, A SIGNAL IS INPUT TO TERMINAL 2 OF DOOR LOCK ECU. AS A RESULT, THE ECU TURNS OFF AND UP AND DOWN OF THE MOVEMENT OF THE WINDOW STOPS.



POWER WINDOW

SERVICE HINTS

D 7 DOOR LOCK ECU

- 8-GROUND:ALWAYS APPROX. 12VOLTS
- 16-GROUND:ALWAYS CONTINUITY
- 1-GROUND:APPROX. 12VOLTS WITH IGNITION SW AT ON POSITION
- 2-GROUND:CONTINUITY WITH DRIVER'S DOOR OPENED
- 15-GROUND:APPROX. 12VOLTS WITH IGNITION SW ON AND STAYS AT 12VOLTS FOR 60SECONDS AFTER THE IGNITION SW IS TURNED OFF, BUT IF A DOOR IS OPENED IN THIS 60SECONDS PERIOD, VOLTAGE WILL DROP TO 0VOLTS

D10 DOOR COURTESY SW

- 2-GROUND:CONTINUITY WITH DRIVER'S DOOR OPEN

P12 POWER WINDOW SW RH

- 5-GROUND:APPROX. 12VOLTS WITH IGNITION SW ON AND STAYS AT 12VOLTS FOR 60SECONDS AFTER THE IGNITION SW IS TURNED OFF, BUT IF A DOOR IS OPENED IN THIS 60SECONDS PERIOD, VOLTAGE WILL DROP TO 0VOLTS

P13 POWER WINDOW MASTER SW AND DOOR LOCK CONTROL SW LH

- 6-GROUND:ALWAYS CONTINUITY
- 9-GROUND:APPROX. 12VOLTS WITH IGNITION SW ON AND STAYS AT 12VOLTS FOR 60SECONDS AFTER THE IGNITION SW IS TURNED OFF, BUT IF A DOOR IS OPENED IN THIS 60SECONDS PERIOD, VOLTAGE WILL DROP TO 0VOLTS
- 3-GROUND:APPROX. 12VOLTS WITH IGNITION SW AT ON POSITION AND DRIVER'S SW AT UP POSITION
- 4-GROUND:APPROX. 12VOLTS WITH IGNITION SW AT ON POSITION AND DRIVER'S SW AT DOWN OR AUTO DOWN POSITION

WINDOW LOCK SW

- OPEN WITH WINDOW LOCK SW AT LOCK POSITION

○ : PARTS LOCATION

CODE	SEE PAGE	CODE	SEE PAGE	CODE	SEE PAGE
D 6	22	J 3	22	P14	23
D 7	22	P 2	22	P15	23
D10	23	P12	23		
J 1	22	P13	23		

○ : RELAY BLOCKS

CODE	SEE PAGE	RELAY BLOCKS (RELAY BLOCK LOCATION)
1	18	R/B NO.1 (LEFT KICK PANEL)

○ : JUNCTION BLOCK AND WIRE HARNESS CONNECTOR

CODE	SEE PAGE	JUNCTION BLOCK AND WIRE HARNESS (CONNECTOR LOCATION)
3A	19	COWL WIRE AND J/B NO.3 (BEHIND COMBINATION METER)
3B		
3C		
3D		

□ : CONNECTOR JOINING WIRE HARNESS AND WIRE HARNESS

CODE	SEE PAGE	JOINING WIRE HARNESS AND WIRE HARNESS (CONNECTOR LOCATION)
IE4	28	ENGINE ROOM MAIN WIRE AND COWL WIRE (LEFT KICK PANEL)
IF1	28	COWL WIRE AND FRONT DOOR LH WIRE (LEFT KICK PANEL)
IF2	28	FRONT DOOR LH WIRE AND COWL WIRE (LEFT KICK PANEL)
IJ2	30	FRONT DOOR RH WIRE AND COWL WIRE (RIGHT KICK PANEL)

▽ : GROUND POINTS

CODE	SEE PAGE	GROUND POINTS LOCATION
IB	28	LEFT KICK PANEL
IC	28	INSTRUMENT PANEL BRACE LH

○ : SPLICE POINTS

CODE	SEE PAGE	WIRE HARNESS WITH SPLICE POINTS	CODE	SEE PAGE	WIRE HARNESS WITH SPLICE POINTS
I 5	30	COWL WIRE			

D 6 BLACK



D 7

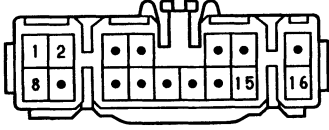

D10



J 1

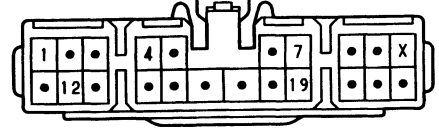

J 3

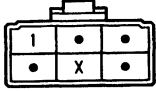

P 2

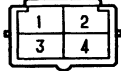

P12



P13

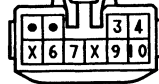

P14.P15

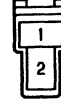



DOOR LOCK

FROM POWER SOURCE SYSTEM (SEE PAGE 44)

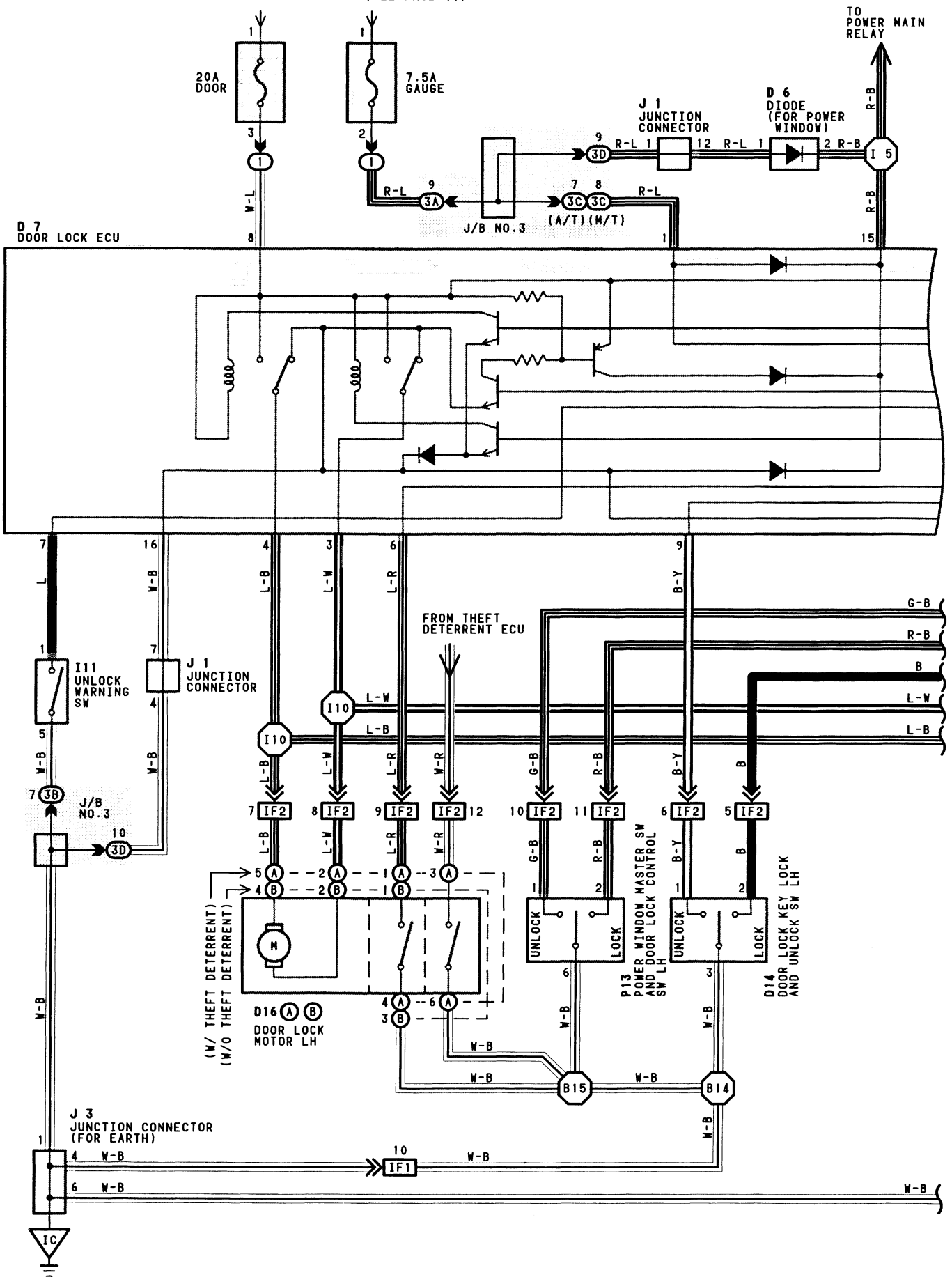

D 7
DOOR LOCK ECU

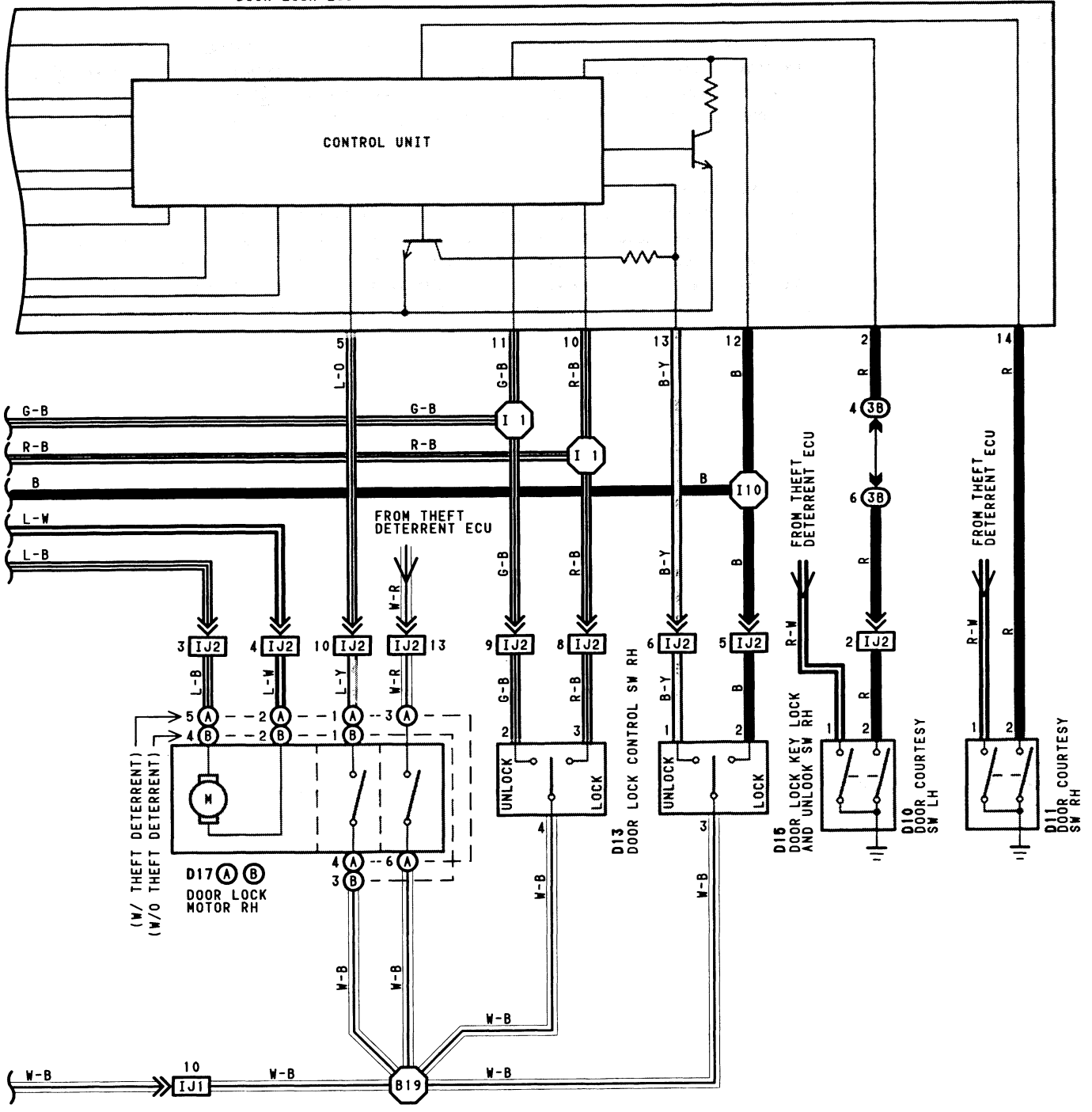



DOOR LOCK

SYSTEM OUTLINE

CURRENT ALWAYS FLOWS TO TERMINAL 8 OF THE DOOR LOCK ECU THROUGH THE DOOR FUSE.

WITH THE IGNITION SW TURNED ON, CURRENT FLOWS THROUGH THE GAUGE FUSE TO TERMINAL 1 OF THE DOOR LOCK ECU AND TERMINAL 1 OF DIODE → TERMINAL 2 → TERMINAL 15 OF DOOR LOCK ECU.

1. MANUAL LOCK OPERATION

TO CHANGE DOOR LOCK SW AND KEY SW TO LOCK POSITION, A LOCK SIGNAL IS INPUT TO TERMINAL 10, 12 OF THE DOOR LOCK ECU AND CAUSES THE ECU TO FUNCTION. CURRENT FLOWS FROM TERMINAL 8 OF THE ECU → TERMINAL 4 → TERMINAL (A) 5 (W/ THEFT DETERRENT), (B) 4 (W/O THEFT DETERRENT) OF THE DOOR LOCK MOTORS → TERMINAL (A) 2 (W/ THEFT DETERRENT), (B) 2 (W/O THEFT DETERRENT) → TERMINAL 3 OF THE ECU → TERMINAL 16 → TO GROUND AND DOOR LOCK MOTORS CAUSES THE DOOR LOCK.

2. MANUAL UNLOCK OPERATION

TO CHANGE DOOR LOCK CONTROL SW AND KEY SW TO UNLOCK POSITION, AN UNLOCK SIGNAL IS INPUT TO TERMINAL 11, 13 OF THE DOOR LOCK ECU AND CAUSES THE ECU TO FUNCTION. CURRENT FLOWS FROM TERMINAL 8 OF THE ECU → TERMINAL 3 → TERMINAL (A) 2 (W/ THEFT DETERRENT), (B) 2 (W/O THEFT DETERRENT) OF THE DOOR LOCK MOTORS → TERMINAL (A) 5 (W/ THEFT DETERRENT), (B) 4 (W/O THEFT DETERRENT) → TERMINAL 4 OF THE ECU → TERMINAL 16 → TO GROUND AND DOOR LOCK MOTORS CAUSES DOOR TO UNLOCK.

3. DOUBLE OPERATION UNLOCK OPERATION

WHEN THE DOOR LOCK KEY SW (DRIVER'S) IS TURNED TO THE UNLOCK SIDE, ONLY THE DRIVER'S DOOR IS MECHANICALLY UNLOCKED. TURNING THE DOOR LOCK KEY SW (DRIVER'S) TO THE UNLOCK SIDE CAUSES A SIGNAL TO BE INPUT TO TERMINAL 9 OF THE ECU, AND IF THE SIGNAL IS INPUT AGAIN WITHIN 3 SECONDS BY TURNING THE SWITCH TO THE UNLOCK SIDE AGAIN. CURRENT FLOWS TERMINAL 3 OF THE ECU → TERMINAL (A) 2 (W/ THEFT DETERRENT), (B) 2 (W/O THEFT DETERRENT) OF DOOR LOCK MOTORS → TERMINAL (A) 5 (W/ THEFT DETERRENT), (B) 4 (W/O THEFT DETERRENT) → TERMINAL 4 OF ECU → TERMINAL 16 → GROUND, CAUSING THE DOOR LOCK MOTORS TO OPERATE AND UNLOCK THE PASSENGER'S DOOR.

4. IGNITION KEY REMINDER OPERATION

* OPERATING DOOR LOCK KNOB (IN DOOR LOCK MOTORS OPERATION)

WITH IGNITION KEY IN CYLINDER (UNLOCK WARNING SW ON), WHEN THE DOOR IS OPENED AND LOCKED USING DOOR LOCK KNOB (DOOR LOCK MOTOR), THE DOOR IS LOCKED ONCE BUT EACH DOOR IS UNLOCKED SOON BY THE FUNCTION OF ECU. AS A RESULT, THE CURRENT FLOWS FROM TERMINAL 8 OF THE ECU → TERMINAL 3 → TERMINAL (A) 2 (W/ THEFT DETERRENT), (B) 2 (W/O THEFT DETERRENT) OF THE DOOR LOCK MOTORS → TERMINAL (A) 5 (W/ THEFT DETERRENT), (B) 4 (W/O THEFT DETERRENT) → TERMINAL 4 OF THE ECU → TERMINAL 16 → TO GROUND AND CAUSES ALL THE DOORS TO UNLOCK.

* OPERATING DOOR LOCK CONTROL SW OR DOOR LOCK KEY SW

WITH IGNITION KEY IN CYLINDER (UNLOCK WARNING SW ON), WHEN THE DOOR IS OPENED AND LOCKED USING DOOR LOCK CONTROL SW OR KEY SW, THE DOORS ARE LOCKED ONCE BUT EACH DOOR IS UNLOCK BY THE FUNCTION OF SW CONTAINED IN MOTORS, WHICH THE SIGNAL IS INPUT TO TERMINAL 6 (DRIVER'S) OR 5 (PASSENGER'S) OF THE ECU. ACCORDING TO THIS INPUT SIGNAL, THE CURRENT IN ECU FLOWS FROM TERMINAL 8 OF THE ECU → TERMINAL 3 → TERMINAL (A) 2 (W/ THEFT DETERRENT), (B) 2 (W/O THEFT DETERRENT) OF THE DOOR LOCK MOTORS → TERMINAL (A) 5 (W/ THEFT DETERRENT), (B) 4 (W/O THEFT DETERRENT) → TERMINAL 4 OF THE ECU → TERMINAL 16 → TO GROUND AND CAUSES ALL THE DOORS TO UNLOCK.

* IN CASE OF KEY LESS LOCK

WITH IGNITION KEY IN CYLINDER (UNLOCK WARNING SW ON), WHEN THE UNLOCK FUNCTION IS DISTURBED MORE THAN 0.2 SECONDS, FOR EXAMPLE PUSHING THE DOOR LOCK KNOB ETC., THE DOOR HOLDS ON LOCK CONDITION. CLOSING THE DOOR AFTER, DOOR COURTESY SW INPUTS THE SIGNAL INTO TERMINAL 2 OR 14 OF THE ECU. BY THIS INPUTS SIGNAL, THE ECU WORKS AND CURRENT FLOWS FROM TERMINAL 8 OF THE ECU → TERMINAL 3 → TERMINAL (A) 2 (W/ THEFT DETERRENT), (B) 2 (W/O THEFT DETERRENT) OF THE DOOR LOCK MOTORS → TERMINAL (A) 5 (W/ THEFT DETERRENT), (B) 4 (W/O THEFT DETERRENT) → TERMINAL 4 OF THE ECU → TERMINAL 16 → TO GROUND AND CAUSES ALL THE DOORS TO UNLOCK.

SERVICE HINTS

D 6 DOOR LOCK ECU

- 16-GROUND: ALWAYS CONTINUITY
- 2-GROUND: CONTINUITY WITH DRIVER'S DOOR OPEN
- 8-GROUND: ALWAYS APPROX. 12VOLTS
- 3-GROUND: APPROX. 12VOLTS 0.2SECONDS WITH FLOWING OPERATION
 - *DOOR LOCK CONTROL SW UNLOCKED
 - *DOOR LOCK CONTROL SW LOCKED WITH IGNITION KEY IN CYLINDER AND DRIVER'S DOOR OPEN (IGNITION KEY REMINDER FUNCTION)
 - *DOOR LOCK KNOB LOCKED WITH IGNITION KEY IN CYLINDER AND DRIVER'S DOOR OPEN (IGNITION KEY REMINDER FUNCTION)
 - *UNLOCKING THE DRIVER'S PASSENGER'S DOOR CYLINDER WITH KEY
- 4-GROUND: APPROX. 12VOLTS 0.2SECONDS WITH FLOWING OPERATION
 - *DOOR LOCK CONTROL SW LOCKED
 - *LOCKING THE DRIVER'S PASSENGER'S DOOR CYLINDER WITH KEY
- 10-GROUND: CONTINUITY WITH DOOR LOCK CONTROL SW LOCKED
- 14-GROUND: CONTINUITY WITH PASSENGER'S DOOR OPEN
- 6-GROUND: CONTINUITY WITH DRIVER'S DOOR LOCK KNOB UNLOCKED
- 5-GROUND: CONTINUITY WITH PASSENGER'S DOOR LOCK KNOB UNLOCKED
- 11-GROUND: CONTINUITY WITH DOOR LOCK CONTROL SW UNLOCKED
- 13-GROUND: CONTINUITY WITH PASSENGER'S DOOR LOCK CYLINDER UNLOCKED WITH KEY
- 7-GROUND: CONTINUITY WITH IGNITION KEY IN KEY CYLINDER
- 1-GROUND: APPROX. 12VOLTS WITH IGNITION SW AT ON POSITION
- 9-GROUND: CONTINUITY WITH DRIVER'S DOOR LOCK CYLINDER UNLOCKED WITH KEY
- 15-GROUND: APPROX. 12VOLTS WITH IGNITION SW AT ON POSITION AND STAYS AT 12VOLTS FOR 60SECONDS AFTER THE IGNITION SW IS TURNED OFF, BUT IF A DOOR IS OPENED IN THIS 60SECONDS PERIOD, VOLTAGE WILL DROP TO 0VOLTS
- 12-GROUND: CONTINUITY WITH DRIVER'S, PASSENGER'S DOOR LOCK CYLINDER LOCKED WITH KEY

I11 UNLOCK WARNING SW

- 1-5: CLOSED WITH IGNITION KEY IN CYLINDER

D14, D15 KEY LOCK AND UNLOCK SW

- 1-3: CLOSED WITH DOOR LOCK CYLINDER UNLOCKED WITH KEY
- 2-3: CLOSED WITH DOOR LOCK CYLINDER LOCKED WITH KEY

D10, D11 DOOR COURTESY SW

- 2-GROUND: CLOSED WITH DOOR OPEN

○ : PARTS LOCATION

CODE	SEE PAGE	CODE	SEE PAGE	CODE	SEE PAGE
D 6	22	D14	23	D17	B 23
D 7	22	D15	23	I11	22
D10	23	D16	A 23	J 1	22
D11	23		B 23	J 3	22
D13	23	D17	A 23	P13	23

○ : RELAY BLOCKS

CODE	SEE PAGE	RELAY BLOCKS (RELAY BLOCK LOCATION)
I	18	R/B NO.1 (LEFT KICK PANEL)

○ : JUNCTION BLOCK AND WIRE HARNESS CONNECTOR

CODE	SEE PAGE	JUNCTION BLOCK AND WIRE HARNESS (CONNECTOR LOCATION)
3A	19	COWL WIRE AND J/B NO.3 (BEHIND COMBINATION METER)
3B		
3C		
3D		

□ : CONNECTOR JOINING WIRE HARNESS AND WIRE HARNESS

CODE	SEE PAGE	JOINING WIRE HARNESS AND WIRE HARNESS (CONNECTOR LOCATION)
IF1	28	COWL WIRE AND FRONT DOOR LH WIRE (LEFT KICK PANEL)
IF2	28	FRONT DOOR LH WIRE AND COWL WIRE (LEFT KICK PANEL)
IJ1	30	COWL WIRE AND FRONT DOOR RH WIRE (RIGHT KICK PANEL)
IJ2	30	FRONT DOOR RH WIRE AND COWL WIRE (RIGHT KICK PANEL)

▽ : GROUND POINTS

CODE	SEE PAGE	GROUND POINTS LOCATION
IC	28	INSTRUMENT PANEL BRACE LH

○ : SPLICE POINTS

CODE	SEE PAGE	WIRE HARNESS WITH SPLICE POINTS	CODE	SEE PAGE	WIRE HARNESS WITH SPLICE POINTS
I 5	30	COWL WIRE	B15	32	FRONT DOOR RH WIRE
I10			B19	32	FRONT DOOR LH WIRE
B14	32	FRONT DOOR RH WIRE			



DOOR LOCK

D 6 BLACK



D 7

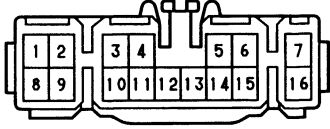

D10, D11



D13

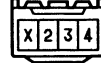

D14, D15 GRAY



D16 (A), D17 (A)

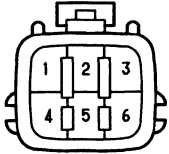

D16 (B), D17 (B)



I11 BLACK

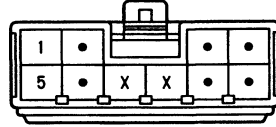

J 1

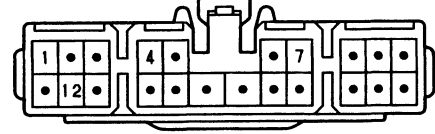

J 3

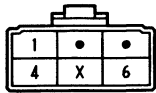

P13

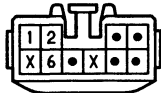

UNLOCK AND SEAT BELT WARNING



B 4



C10 (B) BLUE

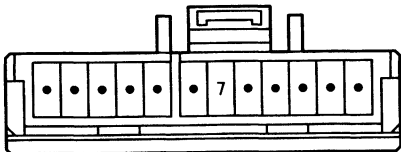

C11 (A)

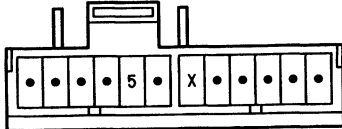

D10



I11 BLACK

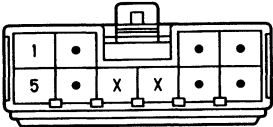

J 3

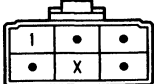

S 8

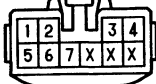



UNLOCK AND SEAT BELT WARNING

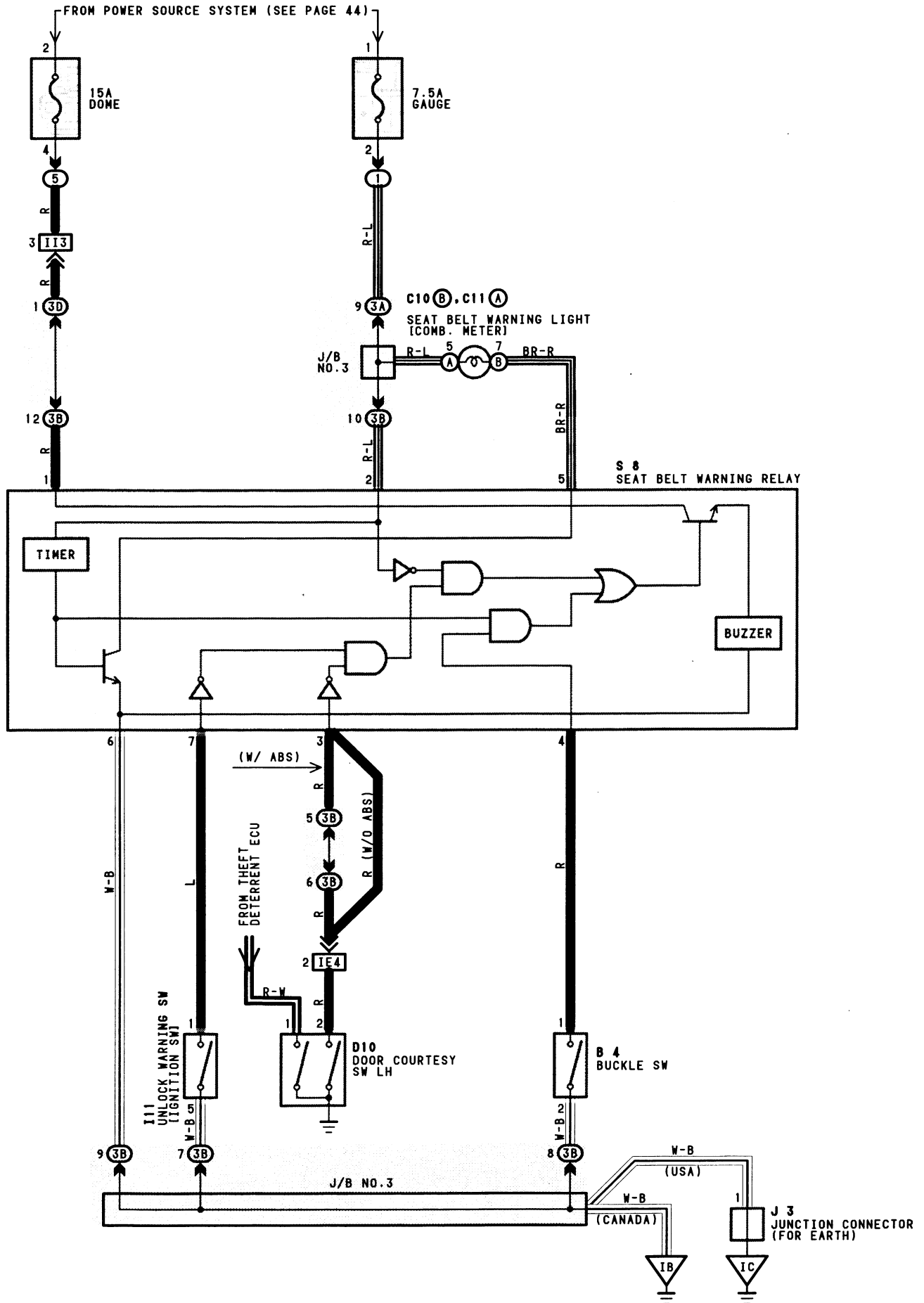

SYSTEM OUTLINE

CURRENT ALWAYS FLOWS TO TERMINAL 1 OF THE SEAT BELT WARNING RELAY THROUGH DOME FUSE.

1. SEAT BELT WARNING SYSTEM

WHEN THE IGNITION SW IS TURNED ON, CURRENT FLOWS FROM THE GAUGE FUSE TO TERMINAL 2 OF THE SEAT BELT WARNING RELAY. AT THE SAME TIME, CURRENT FLOWS TO TERMINAL 5 OF THE RELAY FROM THE GAUGE FUSE THROUGH THE SEAT BELT WARNING LIGHT. THIS CURRENT ACTIVATES THE SEAT BELT WARNING RELAY AND, FOR APPROX. 4-8 SECONDS, CURRENT FLOWING THROUGH THE WARNING LIGHT FLOWS FROM TERMINAL 5 OF THE RELAY → TERMINAL 6 → GROUND, CAUSING THE WARNING LIGHT TO LIGHT UP. AT THE SAME AS THE WARNING LIGHT LIGHTS UP, A BUCKLE SW OFF SIGNAL IS INPUT TO TERMINAL 4 OF THE RELAY, THE CURRENT FLOWING TO TERMINAL 1 OF THE RELAY FLOWS FROM TERMINAL 6 → GROUND AND THE SEAT BELT WARNING BUZZER SOUNDS FOR APPROX. 4-8 SECONDS. HOWEVER, IF THE SEAT BELT IS PUT ON (BUCKLE SW ON) DURING THIS PERIOD (WHILE THE BUZZER IS SOUNDING), SIGNAL INPUT TO TERMINAL 4 OF RELAY STOPS AND THE CURRENT FLOW FROM TERMINAL 1 OF THE RELAY → TERMINAL 6 → GROUND IS CUT, CAUSING THE BUZZER TO STOP.

2. UNLOCK WARNING SYSTEM

WITH THE IGNITION KEY INSERTED IN THE KEY CYLINDER (UNLOCK SW ON). THE IGNITION SW STILL OFF AND DOOR OPEN (DOOR COURTESY SW ON), WHEN A SIGNAL IS INPUT TO TERMINAL 3 OF THE RELAY, THE SEAT BELT WARNING RELAY OPERATES, CURRENT FLOWS FROM TERMINAL 1 OF THE RELAY → TERMINAL 6 → GROUND AND THE UNLOCK WARNING BUZZER SOUNDS.

SERVICE HINTS

I11 UNLOCK WARNING SW (IGNITION SW)

1-5: CLOSED WITH IGNITION KEY IN CYLINDER

S 8 SEAT BELT WARNING RELAY

6-GROUND: ALWAYS CONTINUITY

3-GROUND: CONTINUITY WITH DRIVER'S DOOR OPEN

7-GROUND: CONTINUITY WITH IGNITION KEY IN CYLINDER

4-GROUND: CONTINUITY WITH DRIVER'S LAP BELT IN USE

5-GROUND: 0VOLTS FOR 4-8 SECONDS WITH IGNITION SW ON AND APPROX. 12VOLTS 4-8 SECONDS AFTER IGNITION SW ON

1-GROUND: ALWAYS APPROX. 12VOLTS

D10 DOOR COURTESY SW

2-GROUND: CLOSED WITH DRIVER'S DOOR OPEN

B 4 BUCKLE SW

1-2: CLOSED WITH DRIVER'S LAP BELT IN USE

○ : PARTS LOCATION

CODE	SEE PAGE	CODE	SEE PAGE	CODE	SEE PAGE
B 4	22	D10	23	S 8	22
C10	B 22	I11	22		
C11	A 22	J 3	22		

○ : RELAY BLOCKS

CODE	SEE PAGE	RELAY BLOCKS (RELAY BLOCK LOCATION)
1	18	R/B NO.1 (LEFT KICK PANEL)
5	17	R/B NO.5 (FRONT LUGGAGE COMPARTMENT RIGHT)

○ : JUNCTION BLOCK AND WIRE HARNESS CONNECTOR

CODE	SEE PAGE	JUNCTION BLOCK AND WIRE HARNESS (CONNECTOR LOCATION)
3A	19	COWL WIRE AND J/B NO.3 (BEHIND COMBINATION METER)
3B		
3D		

□ : CONNECTOR JOINING WIRE HARNESS AND WIRE HARNESS

CODE	SEE PAGE	JOINING WIRE HARNESS AND WIRE HARNESS (CONNECTOR LOCATION)
IE4	28	ENGINE ROOM MAIN WIRE AND COWL WIRE (LEFT KICK PANEL)
I13	30	LUGGAGE ROOM WIRE AND COWL WIRE (RIGHT KICK PANEL)

▽ : GROUND POINTS

CODE	SEE PAGE	GROUND POINTS LOCATION
IB	28	LEFT KICK PANEL
IC	28	INSTRUMENT PANEL BRACE LH



WIPER AND WASHER

FROM POWER SOURCE SYSTEM (SEE PAGE 44)

C14
WIPER AND WASHER SW (W/ WIPER RELAY)
(COMB. SW)

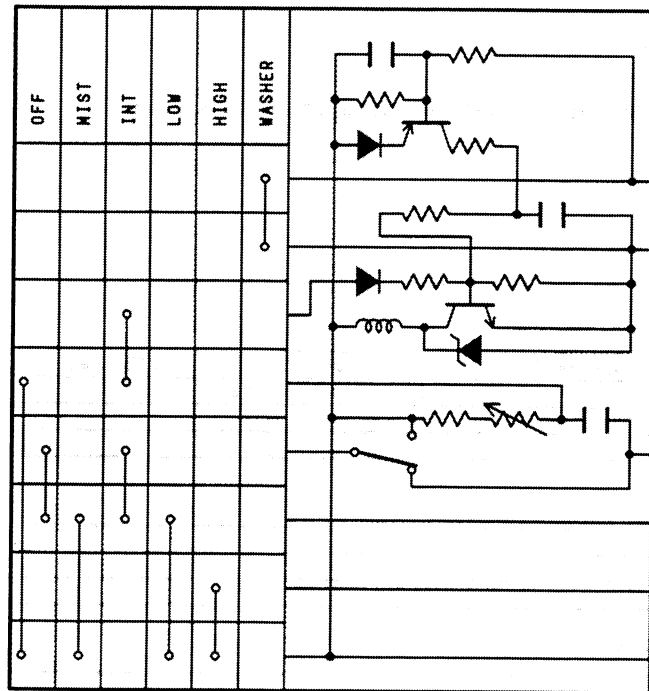

W 2
WASHER MOTOR

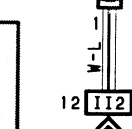

J 3
JUNCTION CONNECTOR
(FOR EARTH)

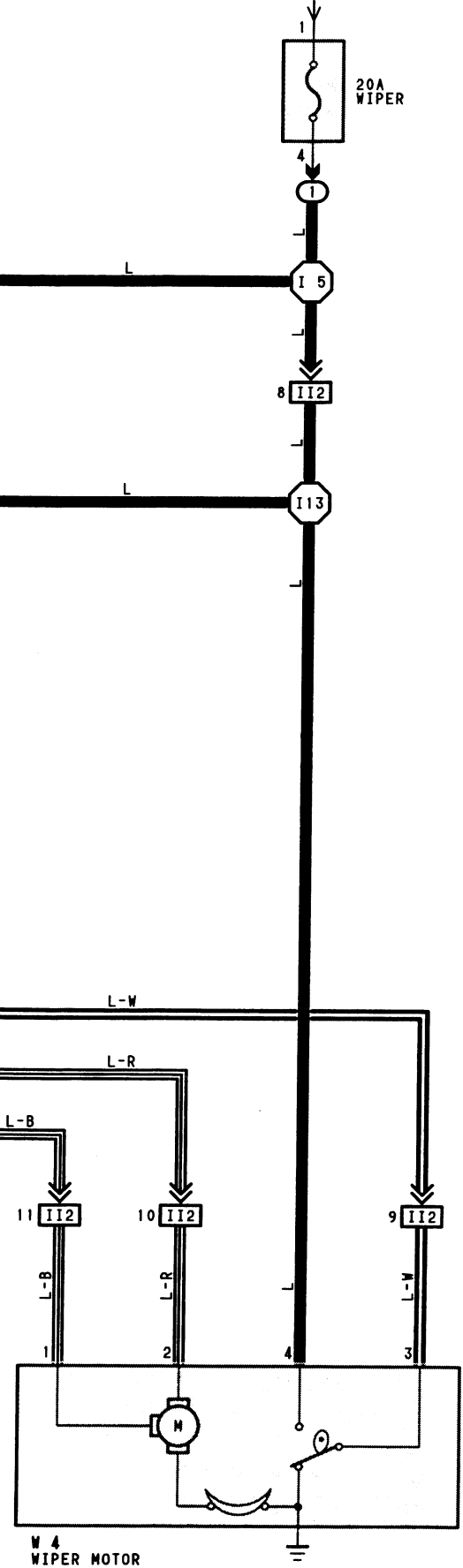
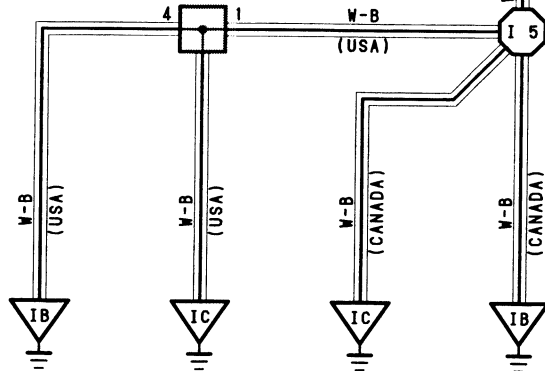

SYSTEM OUTLINE

WITH THE IGNITION SW TURNED ON, THE CURRENT FLOWS TO **TERMINAL 18** OF THE WIPER AND WASHER SW, **TERMINAL 2** OF THE WASHER MOTOR AND **TERMINAL 4** OF THE FRONT WIPER MOTOR THROUGH THE WIPER FUSE.

1. LOW SPEED POSITION

WITH WIPER SW TURNED TO **LOW** POSITION, THE CURRENT FLOWS FROM **TERMINAL 18** OF THE WIPER AND WASHER SW → **TERMINAL 7** → **TERMINAL 2** OF THE FRONT WIPER MOTOR → FRONT WIPER MOTOR → TO **GROUND** AND CAUSES TO THE WIPER MOTOR TO RUN AT **LOW** SPEED.

2. HIGH SPEED POSITION

WITH WIPER SW TURNED TO **HIGH** POSITION, THE CURRENT FLOWS FROM **TERMINAL 18** OF THE WIPER AND WASHER SW → **TERMINAL 13** → **TERMINAL 1** OF THE FRONT WIPER MOTOR → FRONT WIPER MOTOR → TO **GROUND** AND CAUSES TO THE WIPER MOTOR TO RUN AT **HIGH** SPEED.

3. INT POSITION (W/ INT SW)

WITH WIPER SW TURNED TO **INT** POSITION, THE RELAY OPERATES AND THE CURRENT WHICH IS CONNECTED BY RELAY FUNCTION FLOWS FROM **TERMINAL 18** OF THE WIPER AND WASHER SW → **TERMINAL 15** → TO **GROUND**. THIS FLOWS OF CURRENT OPERATES THE INTERMITTENT CIRCUIT AND THE CURRENT FLOWS FROM **TERMINAL 18** OF THE WIPER AND WASHER SW → **TERMINAL 7** → **TERMINAL 2** OF THE FRONT WIPER MOTOR → FRONT WIPER MOTOR → TO **GROUND** AND FUNCTIONS.

THE INTERMITTENT OPERATION IS CONTROLLED BY A CONDENSER'S CHARGED AND DISCHARGED FUNCTION INSTALLED IN RELAY AND INTERMITTENT TIME IS CONTROLLED BY A TIME CONTROL SW TO CHARGE THE CHARGING TIME OF THE CONDENSER.

4. MIST POSITION (W/ MIST SW)

WITH WIPER SW TURNED TO **MIST** POSITION, THE CURRENT FLOWS FROM **TERMINAL 18** OF THE WIPER AND WASHER SW → **TERMINAL 7** → **TERMINAL 2** OF THE FRONT WIPER MOTOR → FRONT WIPER MOTOR → TO **GROUND** AND CAUSES TO THE WIPER MOTOR TO RUN AT **LOW** SPEED.

5. WASHER CONTINUOUS OPERATION (W/ INT CONTROL)

WITH WASHER SW TURNED TO **ON**, THE CURRENT FLOWS FROM **TERMINAL 2** OF THE WIPER AND WASHER SW → **TERMINAL 1** → **TERMINAL 8** OF THE WIPER AND WASHER SW → **TERMINAL 15** → TO **GROUND** AND CAUSES TO THE WASHER MOTOR TO RUN, AND WINDOW WASHER IS JET. THIS CAUSES THE CURRENT TO FLOW WASHER CONTINUOUS OPERATION CIRCUIT(W/INT SW) IN **TERMINAL 18** OF THE WIPER AND WASHER SW → **TERMINAL 7** → **TERMINAL 2** OF THE FRONT WIPER MOTOR → FRONT WIPER MOTOR → TO **GROUND** AND FUNCTION.

SERVICE HINTS

C14 WIPER AND WASHER SW (W/ WIPER RELAY)

16-GROUND:ALWAYS CONTINUITY
 18-GROUND:APPROX. 12VOLTS WITH IGNITION SW AT ON POSITION
 7-GROUND:APPROX. 12VOLTS WITH WIPER AND WASHER SW AT LOW POSITION
 APPROX. 12VOLTS EVERY APPROX. 1 TO 10SECONDS INTERMITTENTLY WITH WIPER SW AT INT POSITION
 4-GROUND:APPROX. 12VOLTS WITH IGNITION SW ON UNLESS WIPER MOTOR AT STOP POSITION
 13-GROUND:APPROX. 12VOLTS WITH WIPER AND WASHER SW AT HIGH POSITION

W 4 WIPER MOTOR

3-4 :CLOSED UNLESS WIPER MOTOR AT STOP POSITION

○ : PARTS LOCATION

CODE	SEE PAGE	CODE	SEE PAGE	CODE	SEE PAGE
C14	22	W 2	23		
J 3	22	W 4	23		

○ : RELAY BLOCKS

CODE	SEE PAGE	RELAY BLOCKS (RELAY BLOCK LOCATION)
1	18	R/B NO.1 (LEFT KICK PANEL)

□ : CONNECTOR JOINING WIRE HARNESS AND WIRE HARNESS

CODE	SEE PAGE	JOINING WIRE HARNESS AND WIRE HARNESS (CONNECTOR LOCATION)
II2	30	LUGGAGE ROOM WIRE AND COWL WIRE (RIGHT KICK PANEL)

▽ : GROUND POINTS

CODE	SEE PAGE	GROUND POINTS LOCATION
IB	28	LEFT KICK PANEL
IC	28	INSTRUMENT PANEL BRACE LH



WIPER AND WASHER



: SPLICE POINTS

CODE	SEE PAGE	WIRE HARNESS WITH SPLICE POINTS	CODE	SEE PAGE	WIRE HARNESS WITH SPLICE POINTS
I 5	30	COWL WIRE	I13	30	LUGGAGE ROOM WIRE

C14 BLACK

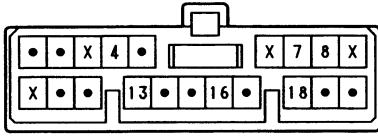

J 3

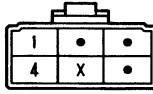

W 2 BLACK



W 4 GRAY



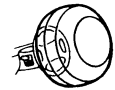

NOTICE: When inspecting or repairing the SRS AIRBAG, perform the operation in accordance with the following precautionary instructions and the procedure and precautions in the Repair Manual for the applicable model year.

- Malfunction symptoms of the airbag system are difficult to confirm, so the diagnostic codes become the most important source of information when troubleshooting.
When troubleshooting the airbag system, always inspect the diagnostic codes before disconnecting the battery.
- Work must be started after 20 seconds or longer from the time the Ignition SW is set to the "LOCK" position and the negative (–) terminal cable is disconnected from the battery.
(The airbag system is equipped with a back-up power source so that if work is started within 20 seconds of disconnecting the negative (–) terminal cable of the battery, the airbag may be deployed.)
When the negative (–) terminal cable is disconnected from the battery, memory of the clock and audio systems will be cancelled. So before starting work, make a record of the contents memorized by each memory system. Then when work is finished, reset the clock and audio system as before.
To avoid erasing the memory of each memory system, never use a back-up power supply from outside the vehicle.
- When removing the steering wheel pad or handling a new steering wheel pad, keep the pad upper surface facing upward. Also, lock the lock lever of the twin lock type connector at the rear of the pad and take care not to damage the connector.
(Storing the pad with its metallic surface up may lead to a serious accident if the airbag inflates for some reason.)
- Store the steering wheel pad where the ambient temperature remains below 93°C (200°F), without high humidity and away from electrical noise.
- Never use airbag parts from another vehicle. When replacing airbag parts, replace them with new parts.
- Never disassemble or repair the steering wheel pad, center airbag sensor assembly or front airbag sensors.
- Before repairing the body, remove the airbag sensors if during repair shocks are likely to be applied to the sensors due to vibration of the body or direct tapping with tools or other parts.
- Do not reuse a steering wheel pad or front airbag sensors.
After evaluating whether the center airbag sensor assembly is damaged or not, decide whether or not to reuse it. (See the Repair Manual for the method for evaluating the center airbag sensor assembly.)
- When troubleshooting the airbag system, use a high-impedance (Min. 10kΩ/V) tester.
- The wire harness of the airbag system is combined with the cowl wiring harness assembly.
The vehicle wiring harness exclusively for the airbag system is distinguished by corrugated yellow tubing, as are the connectors.
- Do not measure the resistance of the airbag squib.
(It is possible this will deploy the airbag and is very dangerous.)
- If the wire harness used in the airbag system is damaged, replace the whole wire harness assembly.
When the connector to the airbag front sensors can be repaired alone (when there is no damage to the wire harness), use the repair wire specially designed for the purpose.
(Refer to the Repair Manual for the applicable Model year for details of the replacement method.)
- INFORMATION LABELS (NOTICES) are attached to the periphery of the airbag components. Follow the instructions on the notices.

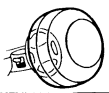

The airbag system has connectors which possess the functions described below:

1. AIRBAG ACTIVATION PREVENTION MECHANISM

Each connector contains a short spring plate. When the connector is disconnected, the short spring plate automatically connects the power source and grounding terminals of the squib to preclude a potential difference between the terminals.

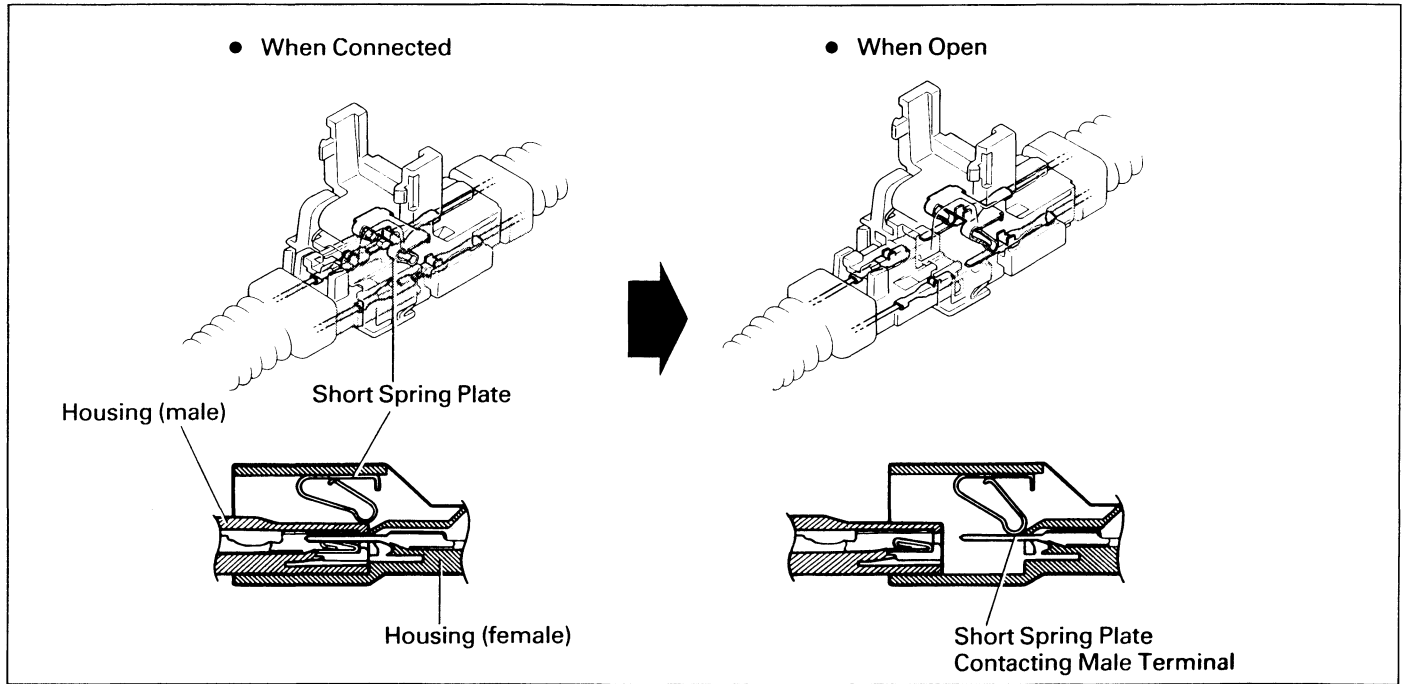

2. ELECTRICAL CONNECTION CHECK MECHANISM

This mechanism is designed to electrically check if connectors are connected correctly and completely. The electrical connection check mechanism is designed so that the connection detection pin connects with the diagnosis terminals when the connector housing lock is in the locked condition.

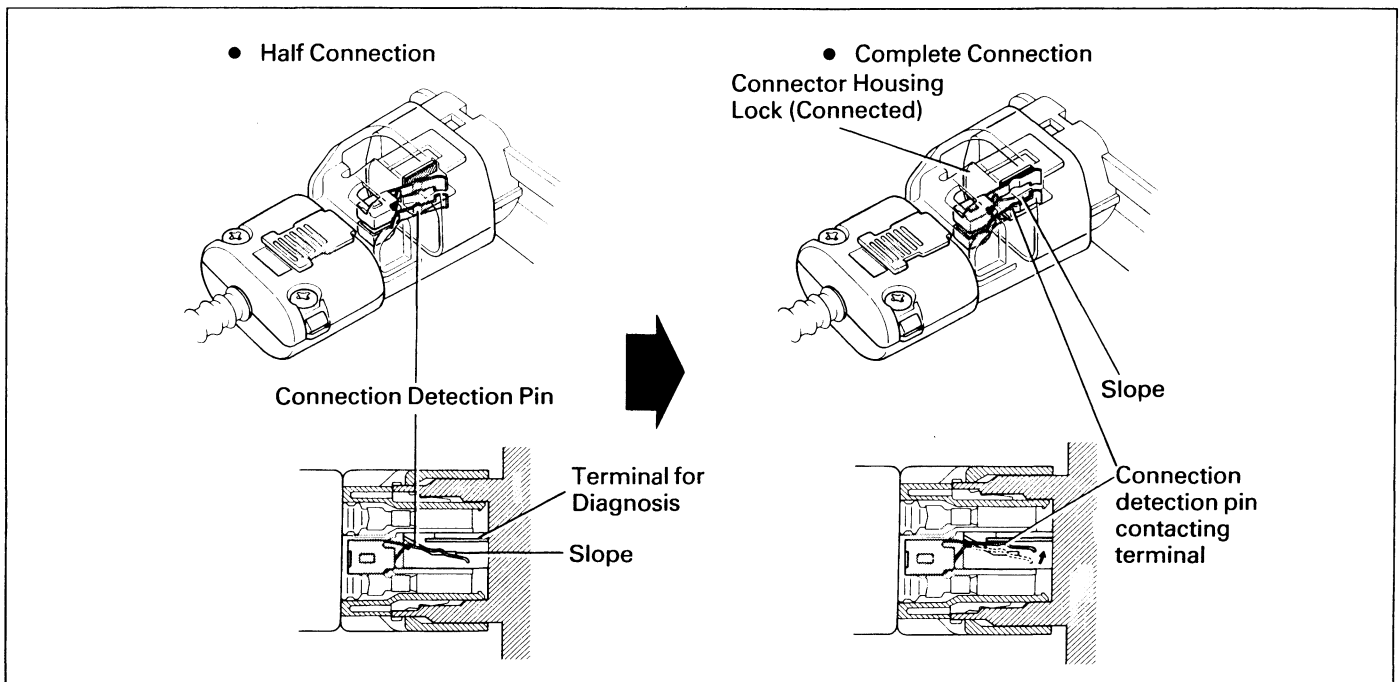

3. CONNECTOR TWIN-LOCK MECHANISM

With this mechanism connectors (male and female connectors) are locked by two locking devices to increase connection reliability. If the primary lock is incomplete, ribs interfere and prevent the secondary lock.

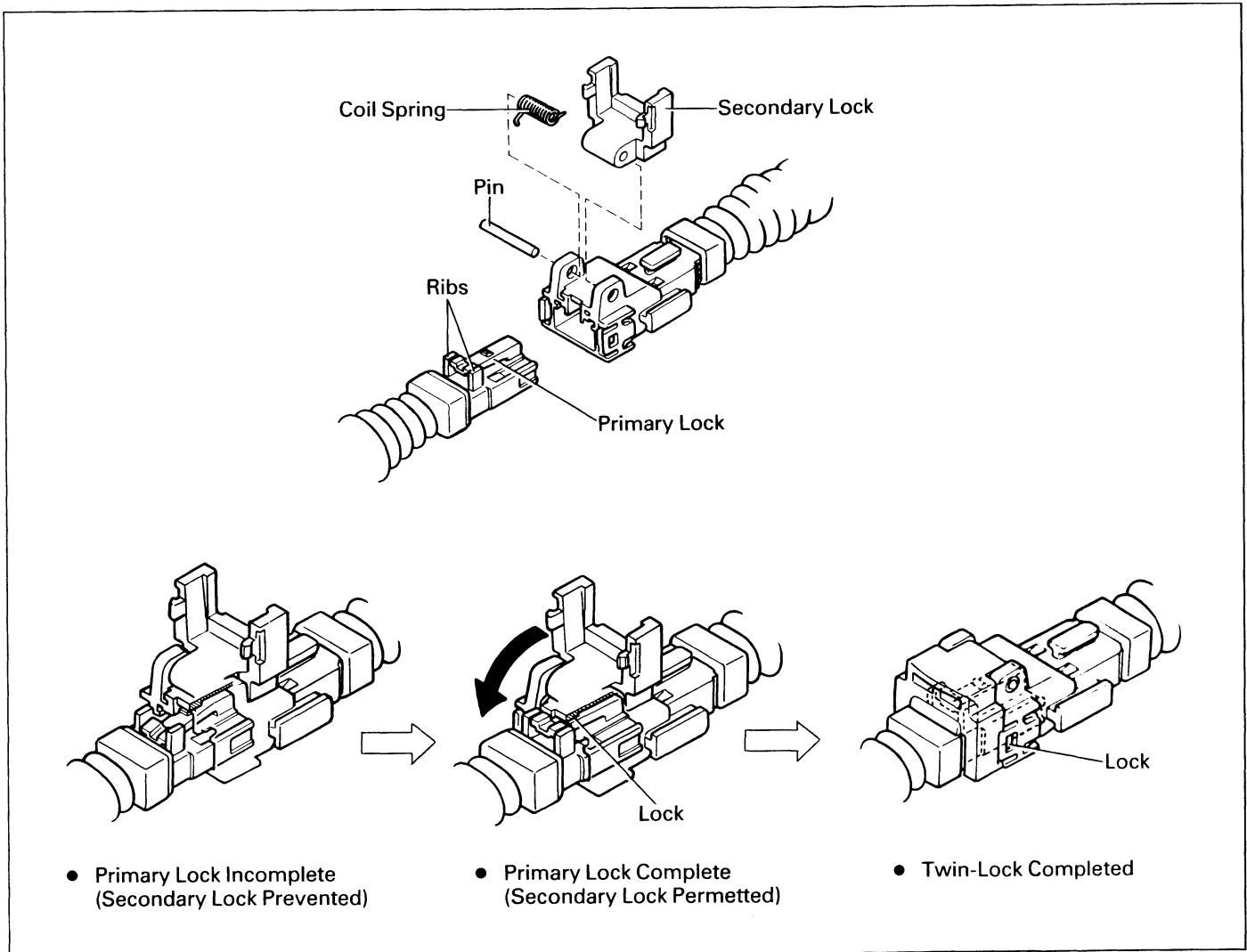

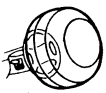

SRS AIRBAG

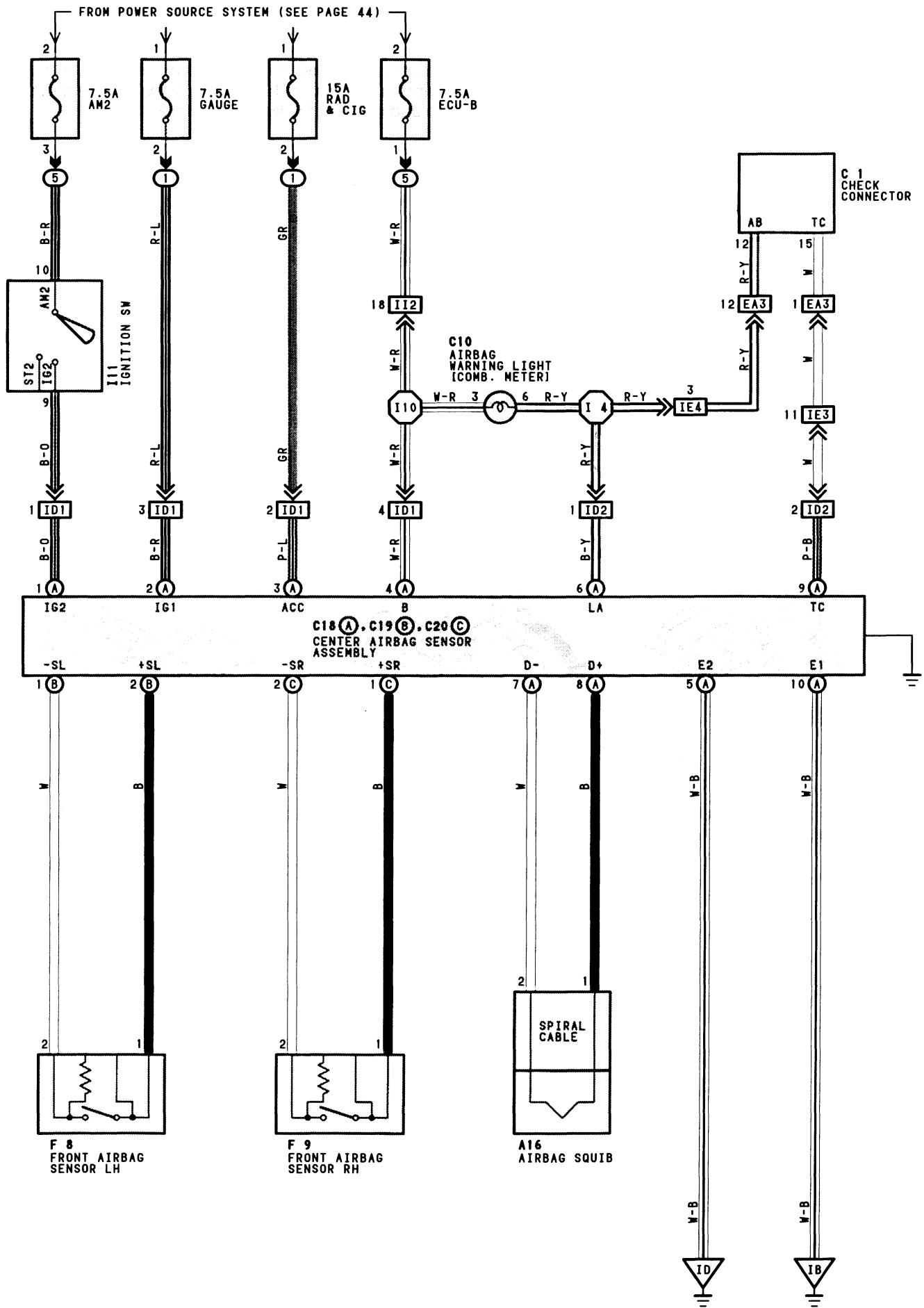

SYSTEM OUTLINE

THE SRS (SUPPLEMENTAL RESTRAINT SYSTEM) AIRBAG IS A DRIVER PROTECTION DEVICE WHICH HAS A SUPPLEMENTAL ROLE TO THE SEAT BELTS.

CURRENT FLOWS CONSTANTLY TO TERMINAL (A) 4 OF THE CENTER AIRBAG SENSOR ASSEMBLY. WHEN THE IGNITION SW IS TURNED TO ACC OR ON, CURRENT FROM THE RAD & CIG FUSE FLOW TO TERMINAL (A) 3 OF THE CENTER AIRBAG SENSOR ASSEMBLY. ONLY WHEN THE IGNITION SW IS ON DOES THE CURRENT FROM THE GAUGE FUSE FLOW TO TERMINAL (A) 1, AND THE CURRENT FROM THE AMI FUSE TO TERMINAL (A) 2.

IF AN ACCIDENT OCCURS WHILE DRIVING, DECELERATION CAUSED BY A FRONTAL IMPACT IS DETECTED BY EACH SENSOR AND SWITCH, AND WHEN THE FRONTAL IMPACT EXCEEDS A SET LEVEL (WHEN THE MERCURY SW BUILT INTO THE CENTER AIRBAG SENSOR ASSEMBLY IS ON AND THE CENTER AIRBAG SENSOR IS ON, FRONT AIRBAG SENSORS ARE OFF). CURRENT FROM THE RAD & CIG, GAUGE OR AMI FUSE FLOWS TO TERMINAL (A) 8 OF THE CENTER AIRBAG SENSOR ASSEMBLY → TERMINAL 1 OF THE AIRBAG SQUIB → SQUIB → TERMINAL 2 → TERMINAL (A) 7 OF CENTER AIRBAG SENSOR ASSEMBLY → TERMINAL (A) 5, TERMINAL (A) 10 OR BODY GROUND → GROUND.

WHEN THE MERCURY SW BUILT INTO THE CENTER AIRBAG SENSOR ASSEMBLY IS ON AND THE FRONT AIRBAG SENSOR LH OR RH IS ON, CENTER AIRBAG SENSOR IS OFF CURRENT FROM THE RAD & CIG, GAUGE OR AMI FUSE FLOWS TO TERMINAL (A) 8 OF THE CENTER AIRBAG SENSOR ASSEMBLY → TERMINAL 1 OF THE AIRBAG SQUIB → SQUIB → TERMINAL 2 → TERMINAL (A) 7 OF CENTER AIRBAG SENSOR ASSEMBLY → TERMINAL (C) 1 OR (B) 2 → TERMINAL 1 OF FRONT AIRBAG SENSOR → TERMINAL 2 → TERMINAL (C) 2 OR (B) 1 OF CENTER AIRBAG SENSOR ASSEMBLY → TERMINAL (A) 5, TERMINAL (A) 10 OR BODY GROUND → GROUND.

WHEN THE MERCURY SW BUILT INTO THE CENTER AIRBAG SENSOR ASSEMBLY IS ON, AND THE FRONT AIRBAG SENSOR LH OR RH IS ON AND CENTER AIRBAG SENSOR IS ON ONE OF THE ABOVE-MENTIONED CIRCUITS IS ACTIVATED SO THAT CURRENT FLOWS TO THE AIRBAG SQUIB AND CAUSES IT TO OPERATE. THE BAG STORED INSIDE THE STEERING WHEEL PAD IS INSTANTANEOUSLY EXPANDED TO SOFTEN THE SHOCK TO THE DRIVER.

THE REASON WHY THERE ARE MULTIPLE POWER SOURCES AND GROUND POINTS IS SO THAT IN THE EVENT THAT ONE OR TWO OF THE POWER SOURCES AND GROUND POINTS DO NOT WORK FOR SOME REASON, THE REMAINING POWER SOURCE AND GROUND POINT WILL BE AVAILABLE TO COMPENSATE.

○ : PARTS LOCATION

CODE	SEE PAGE	CODE	SEE PAGE	CODE	SEE PAGE	
A16	22	C18	A	22	F 8	23
C 1	20(5S-FE), 21(3S-GTE)	C19	B	22	F 9	23
C10	22	C20	C	22	I11	22

○ : RELAY BLOCKS

CODE	SEE PAGE	RELAY BLOCKS (RELAY BLOCK LOCATION)
1	18	R/B NO.1 (LEFT KICK PANEL)
5	17	R/B NO.5 (FRONT LUGGAGE COMPARTMENT RIGHT)

□ : CONNECTOR JOINING WIRE HARNESS AND WIRE HARNESS

CODE	SEE PAGE	JOINING WIRE HARNESS AND WIRE HARNESS (CONNECTOR LOCATION)
EA3	24(5S-FE)	ENGINE ROOM MAIN WIRE AND ENGINE WIRE (R/B NO.2 INNER)
	26(3S-GTE)	
ID1	28	COWL WIRE AND COWL WIRE (NEAR THE R/B NO.1)
ID2	28	COWL WIRE AND COWL WIRE (BEHIND COMBINATION METER)
IE3	28	ENGINE ROOM MAIN WIRE AND COWL WIRE (LEFT KICK PANEL)
IE4		
II2	30	LUGGAGE ROOM WIRE AND COWL WIRE (RIGHT KICK PANEL)

▽ : GROUND POINTS

CODE	SEE PAGE	GROUND POINTS LOCATION
IB	28	LEFT KICK PANEL
ID	28	RIGHT KICK PANEL

○ : SPLICE POINTS

CODE	SEE PAGE	WIRE HARNESS WITH SPLICE POINTS	CODE	SEE PAGE	WIRE HARNESS WITH SPLICE POINTS
I 4	30	COWL WIRE	I10	30	COWL WIRE

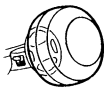

SRS AIRBAG

A16 YELLOW

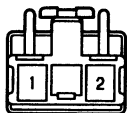

C 1 DARK GRAY

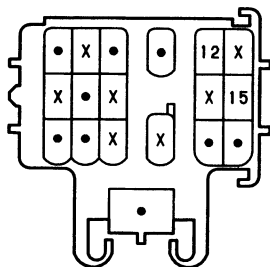

C10 BLUE

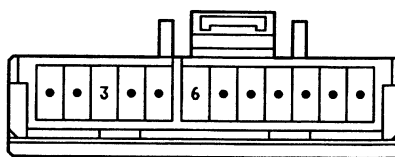

C18 (A) YELLOW

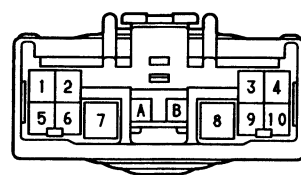

C19 (B) YELLOW

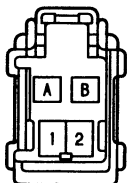

C20 (C) YELLOW

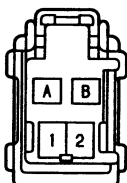

F 8 YELLOW

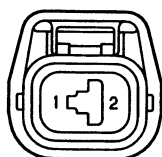

F 9 YELLOW

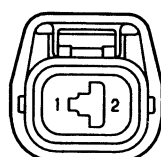

I11 BLACK

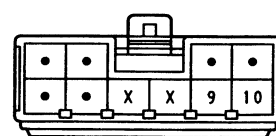

FROM POWER SOURCE SYSTEM (SEE PAGE 44)

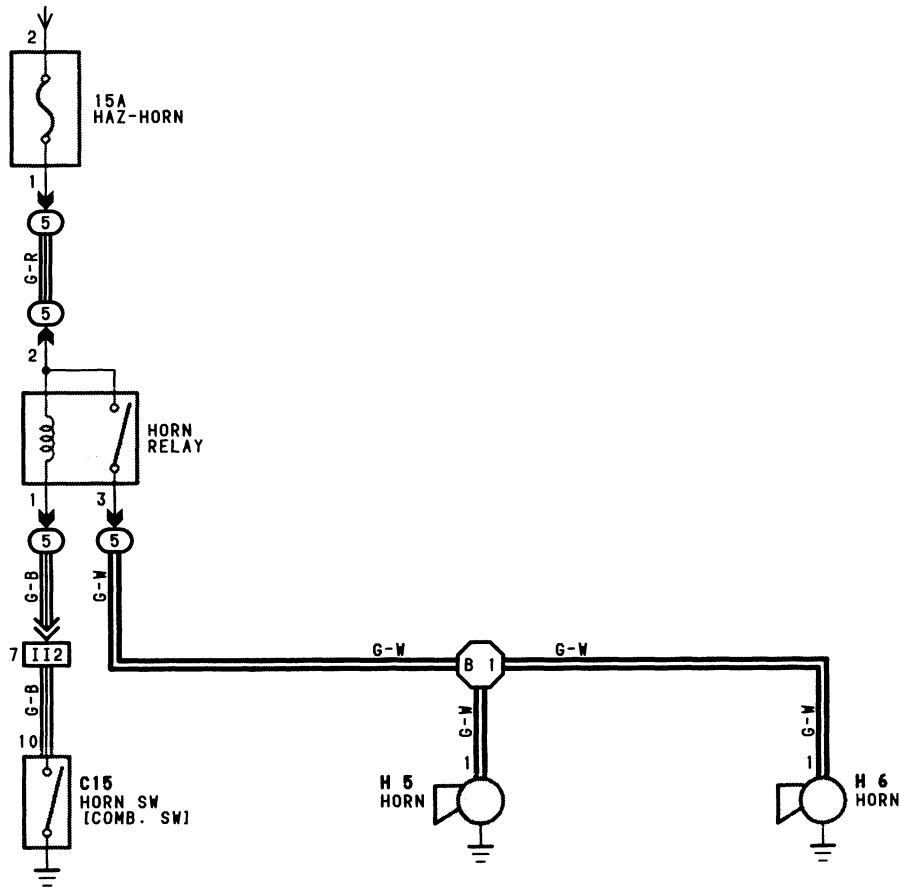

SERVICE HINTS

HORN RELAY

⑤ 2- ⑤ 3: CLOSED WITH HORN SW ON

○ : PARTS LOCATION

CODE	SEE PAGE	CODE	SEE PAGE	CODE	SEE PAGE
C15	22	H 5	23	H 6	23

○ : RELAY BLOCKS

CODE	SEE PAGE	RELAY BLOCKS (RELAY BLOCK LOCATION)
5	17	R/B NO.5 (FRONT LUGGAGE COMPARTMENT RIGHT)

□ : CONNECTOR JOINING WIRE HARNESS AND WIRE HARNESS

CODE	SEE PAGE	JOINING WIRE HARNESS AND WIRE HARNESS (CONNECTOR LOCATION)
II2	30	LUGGAGE ROOM WIRE AND COWL WIRE (RIGHT KICK PANEL)

○ : SPLICE POINTS

CODE	SEE PAGE	WIRE HARNESS WITH SPLICE POINTS	CODE	SEE PAGE	WIRE HARNESS WITH SPLICE POINTS
B 1	32	LUGGAGE ROOM WIRE			

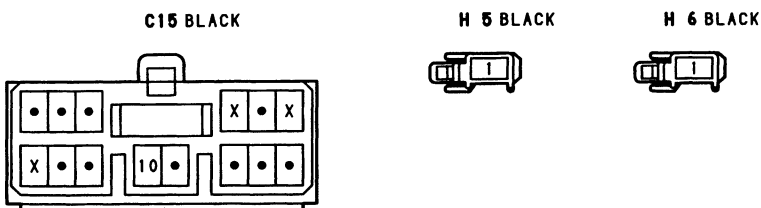



EHPS (ELECTRO HYDRAULIC POWER STEERING)

FROM POWER SOURCE SYSTEM (SEE PAGE 44)

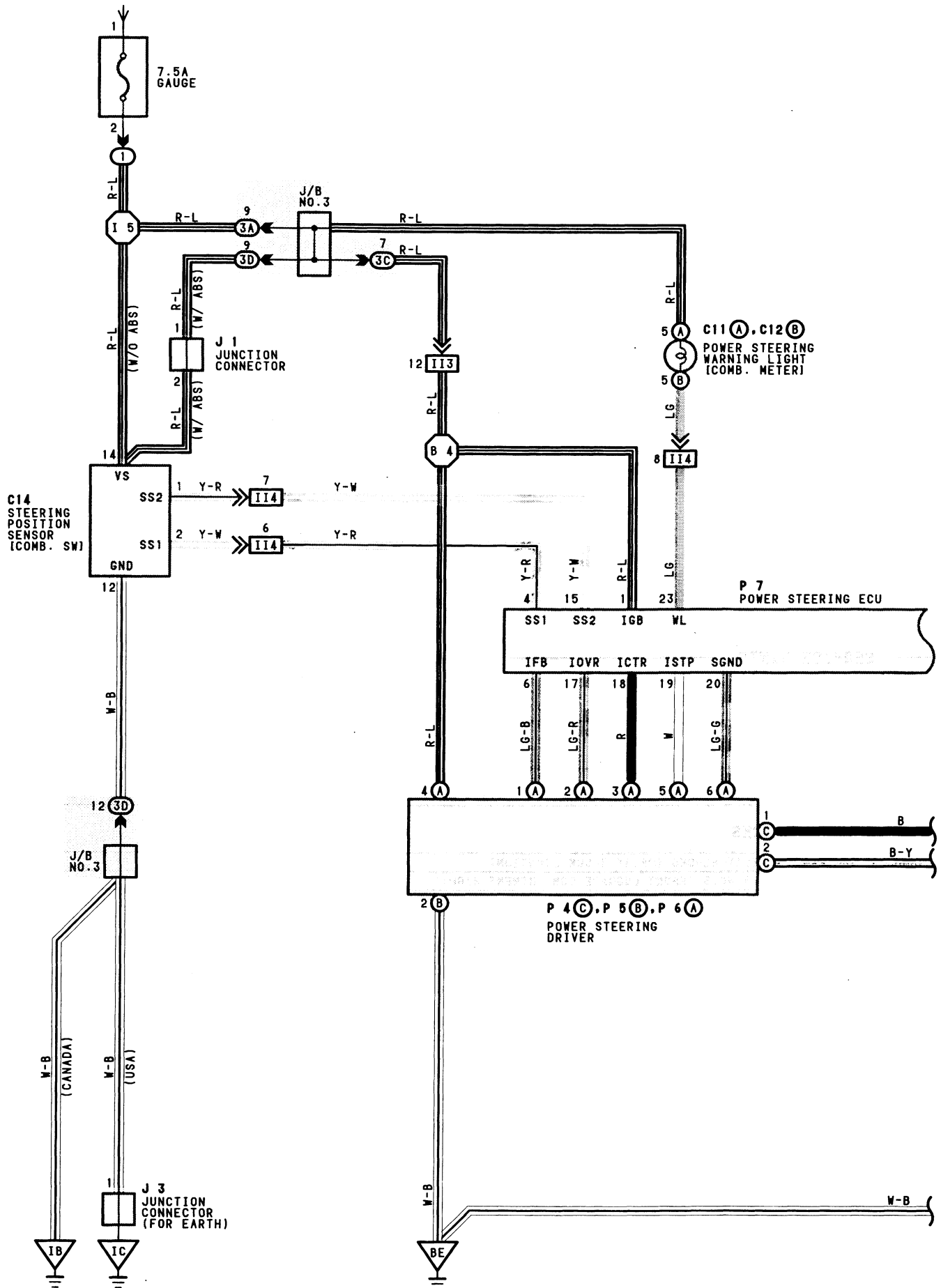



EHPS(ELECTRO HYDRAULIC POWER STEERING)

SYSTEM OUTLINE

THE EHPS (ELECTRO-HYDRAULIC POWER STEERING) SYSTEM FUNCTIONS TO CHANGE FORCE REQUIRED FOR STEERING MANEUVERS, AND THEREBY PROVIDE THE IDEAL STEERING FEELING FOR AU VEHICLE SPEEDS AND STEERING CONDITIONS. THIS IS DONE BY THE POWER STEERING ECU CONTROLLING THE HYDRAULIC PRESSURE ACTING UPON THE HYDRAULIC REACTION CHAMBER (LOCATED IN THE GEAR BOX CONTROL UNIT) BY REGULATING THE POWER STEERING MOTOR'S SPEED (AND HENCE THE AMOUNT OF FLUID FLOW).

EHPS OPERATION

WHEN THE IGNITION SWITCHED ON, STARTING CURRENT FLOWS FROM THE GAUGE FUSE TO **TERMINAL IGB** OF THE POWER STEERING ELECTRONIC CONTROL UNIT, **TERMINAL VS** OF THE STEERING-POSITION SENSOR, AND **TERMINAL A 4** OF THE POWER STEERING DRIVER.

THE VEHICLE SPEED IS DETECTED AT THE SPEED SENSOR, AND SIGNALS ARE INPUT AS CONTROL SIGNALS TO **TERMINAL SPD** OF THE POWER STEERING ELECTRONIC CONTROL UNIT AND TO **TERMINALS SS1** AND **SS2** OF THE POWER STEERING ELECTRONIC CONTROL UNIT.

WHEN THE ENGINE IS STARTED, SIGNALS ARE INPUT TO **TERMINAL EFI** OF THE POWER STEERING ELECTRONIC CONTROL UNIT FROM THE ENGINE OF **TERMINAL PSCT** OF THE ENGINE AND ECT ECU. AS RESULT, THE CURRENT APPLIED TO **TERMINAL IGB** OF THE POWER STEERING ECU FROM THE GAUGE FUSE FLOWS FROM **TERMINAL MRLY** OF THE POWER STEERING ECU → **TERMINAL B 1** OF THE POWER STEERING RELAY → **TERMINAL B 2** → **GROUND**, AND THE POWER STEERING RELAY IS SWITCHED ON. AS A RESULT, THE CURRENT APPLIED TO **TERMINAL A 1** OF THE POWER STEERING RELAY FROM THE ABS FUSE FLOWS FROM **TERMINAL A 2** OF THE POWER STEERING RELAY → **TERMINAL B 1** OF THE POWER STEERING DRIVER AND TO **TERMINAL A 1** OF THE POWER STEERING MOTOR.

IF THE VEHICLE SPEED IS LOW, THE SPEED OF THE POWER STEERING MOTOR IS INCREASED BY INCREASING THE VOLTAGE OF THE CURRENT THAT FLOWS FROM **TERMINAL A 1** OF THE POWER STEERING MOTOR TO **TERMINAL A 2** OF THE POWER STEERING MOTOR → **TERMINAL B 2** OF THE POWER STEERING DRIVER → **TERMINAL C 2** → **GROUND**, WITH THE RESULT THAT THE VOLUME OF FLOW OF THE POWER STEERING FLUID BECOMES GREATER, THUS PROVIDING A LIGHT STEERING FEELING.

WHEN THE VEHICLE SPEED IS HIGH, THE SPEED OF THE POWER STEERING MOTOR DECREASES AS A RESULT OF THE REDUCED VOLTAGE APPLIED TO THE POWER STEERING MOTOR, AND THUS THE VOLUME OF FLOW OF THE POWER STEERING FLUID IS REDUCED, SO THE STEERING FEELING IS MORE RESISTANT.

SERVICE HINTS

P 2 POWER STEERING ECU

- 1-GROUND:APPROX. 12VOLTS WITH IGNITION SW ON
- 12-GROUND:ALWAYS CONTINUITY
- 5-GROUND:1PULSE EACH 40CM (DRIVER VEHICLE SLOWLY)

C14 STEERING POSITION SENSOR (COMB. SW)

- 14-GROUND:APPROX. 12VOLTS WITH IGNITION SW ON
- 12-GROUND:ALWAYS CONTINUITY

P 1 POWER STEERING DRIVER

- A 4-GROUND:APPROX. 12VOLTS WITH IGNITION SW ON
- B 2-GROUND:ALWAYS CONTINUITY

○ : PARTS LOCATION

CODE	SEE PAGE	CODE	SEE PAGE	CODE	SEE PAGE
C 1	20(5S-FE),21(3S-GTE)	E 6	B 20(5S-FE)	P 7	23
C10	C 22		C 20(5S-FE)	P 8	A 23
C11	A 22	J 3	22	P 9	B 23
C12	B 22	P 4	C 23	P10	B 23
C14	22	P 5	B 23	P11	A 23
E 6	A 21(3S-GTE)	P 6	A 23		

○ : RELAY BLOCKS

CODE	SEE PAGE	RELAY BLOCKS (RELAY BLOCK LOCATION)
1	18	R/B NO.1 (LEFT KICK PANEL)

○ : JUNCTION BLOCK AND WIRE HARNESS CONNECTOR

CODE	SEE PAGE	JUNCTION BLOCK AND WIRE HARNESS (CONNECTOR LOCATION)
3A	19	COWL WIRE AND J/B NO.3 (BEHIND COMBINATION METER)
3C		
3D		

□ : CONNECTOR JOINING WIRE HARNESS AND WIRE HARNESS

CODE	SEE PAGE	JOINING WIRE HARNESS AND WIRE HARNESS (CONNECTOR LOCATION)
EA3	24(5S-FE)	ENGINE WIRE AND ENGINE ROOM MAIN WIRE (R/B NO.2 INNER)
	26(3S-GTE)	
IE1 IE3	28	ENGINE ROOM MAIN WIRE AND COWL WIRE (LEFT KICK PANEL)
II3 II4	30	COWL WIRE AND LUGGAGE ROOM WIRE (RIGHT KICK PANEL)

▽ : GROUND POINTS

CODE	SEE PAGE	GROUND POINTS LOCATION
IB	28	LEFT KICK PANEL
IC	28	INSTRUMENT PANEL BRACE LH
ID	28	RIGHT KICK PANEL
BE	32	FRONT RIGHT FENDER
BF	32	FRONT LEFT FENDER

○ : SPLICE POINTS

CODE	SEE PAGE	WIRE HARNESS WITH SPLICE POINTS	CODE	SEE PAGE	WIRE HARNESS WITH SPLICE POINTS
I 4	30	COWL WIRE	B 5	32	LUGGAGE ROOM WIRE
I 5			B 6		
B 4	32	LUGGAGE ROOM WIRE	B 7		

C 1 DARK GRAY

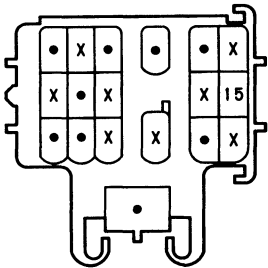

C10 (C) BLUE

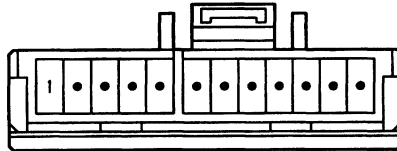

C11 (A)

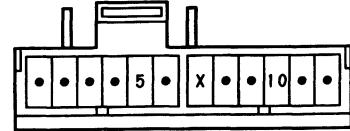

C12 (B) GRAY

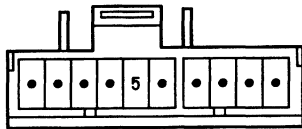

C14 BLACK

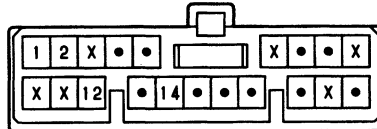

E 6 (A) DARK GRAY

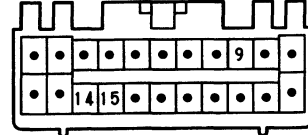

E 6 (B) DARK GRAY

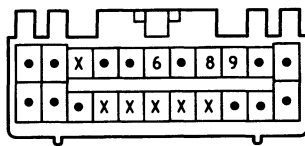

E 6 (C) DARK GRAY

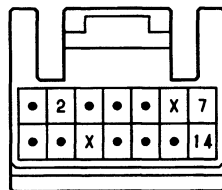

J 3

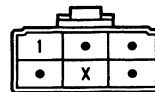

P 4 (C), P10 (B) GRAY

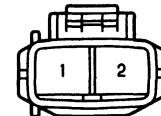

P 5 (B) GRAY

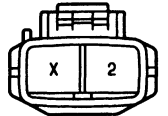

P 6 (A)



P 7

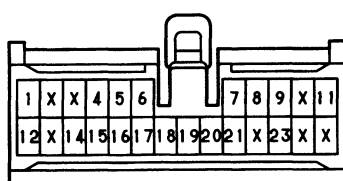

P 8 (A) GRAY

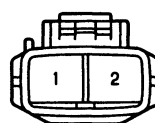

P 9 (B) GRAY



P11 (A) GRAY





REMOTE CONTROL MIRROR

FROM POWER SOURCE SYSTEM (SEE PAGE 44)

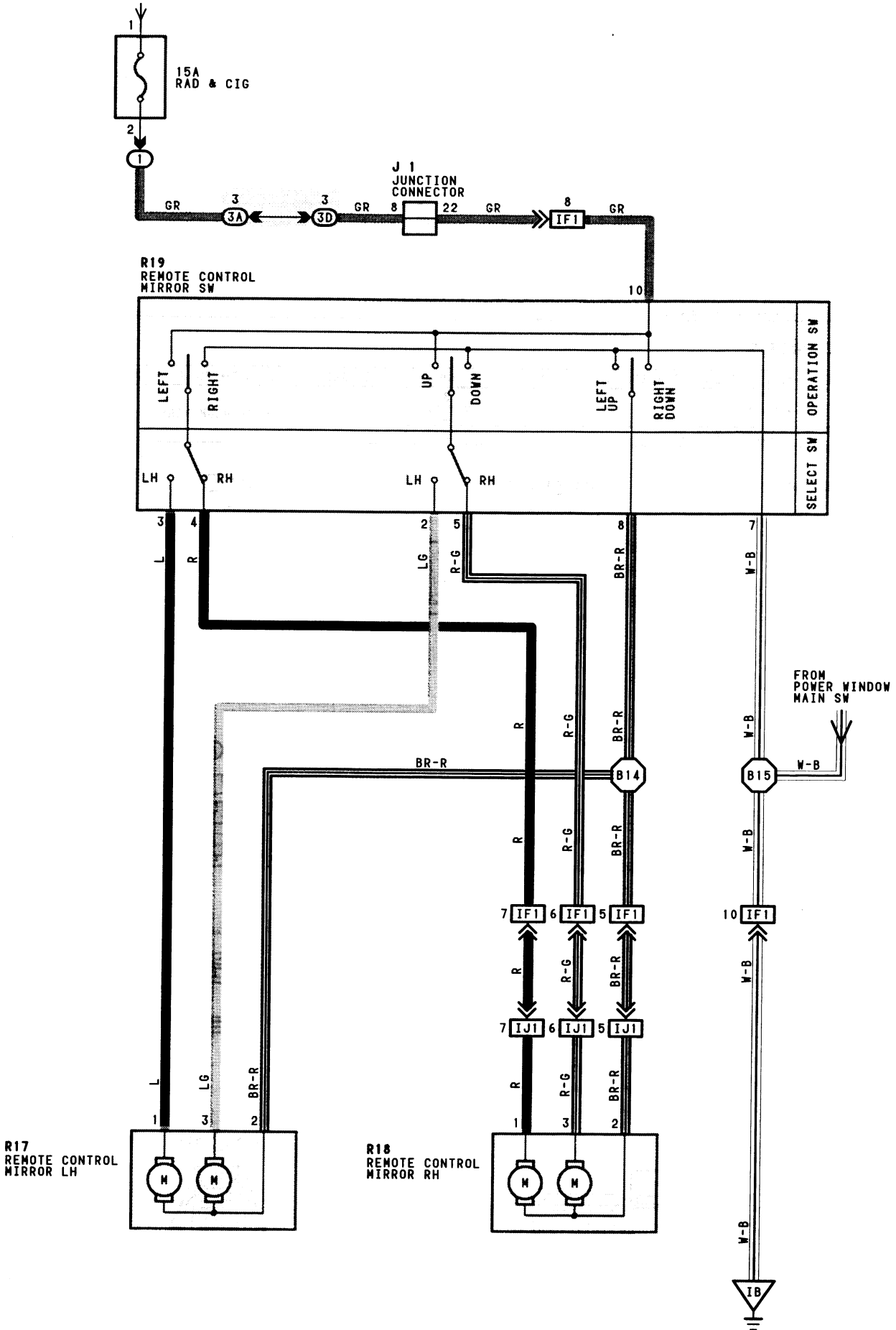

SERVICE HINTS

R19 REMOTE CONTROL MIRROR SW

10-GROUND:APPROX. 12VOLTS WITH IGNITION SW AT ACC OR ON POSITION
 8-7:CONTINUITY WITH OPERATION SW AT UP OR LEFT POSITION
 10-8:CONTINUITY WITH OPERATION SW AT DOWN OR RIGHT POSITION

○ : PARTS LOCATION

CODE	SEE PAGE	CODE	SEE PAGE	CODE	SEE PAGE
J 1	22	R18	23		
R17	23	R19	23		

○ : RELAY BLOCKS

CODE	SEE PAGE	RELAY BLOCKS (RELAY BLOCK LOCATION)
1	18	R/B NO.1 (LEFT KICK PANEL)

○ : JUNCTION BLOCK AND WIRE HARNESS CONNECTOR

CODE	SEE PAGE	JUNCTION BLOCK AND WIRE HARNESS (CONNECTOR LOCATION)
3A	19	COWL WIRE AND J/B NO.3 (BEHIND COMBINATION METER)
3D		

□ : CONNECTOR JOINING WIRE HARNESS AND WIRE HARNESS

CODE	SEE PAGE	JOINING WIRE HARNESS AND WIRE HARNESS (CONNECTOR LOCATION)
IF1	28	COWL WIRE AND FRONT DOOR LH WIRE (LEFT KICK PANEL)
IJ1	30	COWL WIRE AND FRONT DOOR RH WIRE (RIGHT KICK PANEL)

▽ : GROUND POINTS

CODE	SEE PAGE	GROUND POINTS LOCATION
IB	28	LEFT KICK PANEL

○ : SPLICE POINTS

CODE	SEE PAGE	WIRE HARNESS WITH SPLICE POINTS	CODE	SEE PAGE	WIRE HARNESS WITH SPLICE POINTS
B14	32	FRONT DOOR RH WIRE	B15	32	FRONT DOOR RH WIRE

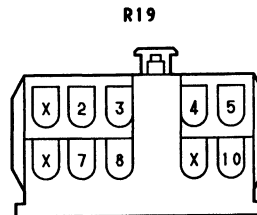
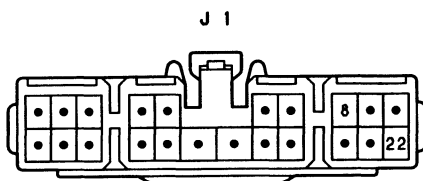



THEFT DETERRENT

○ W/ LIGHT RETAINER CIRCUIT
△ W/O LIGHT RETAINER CIRCUIT

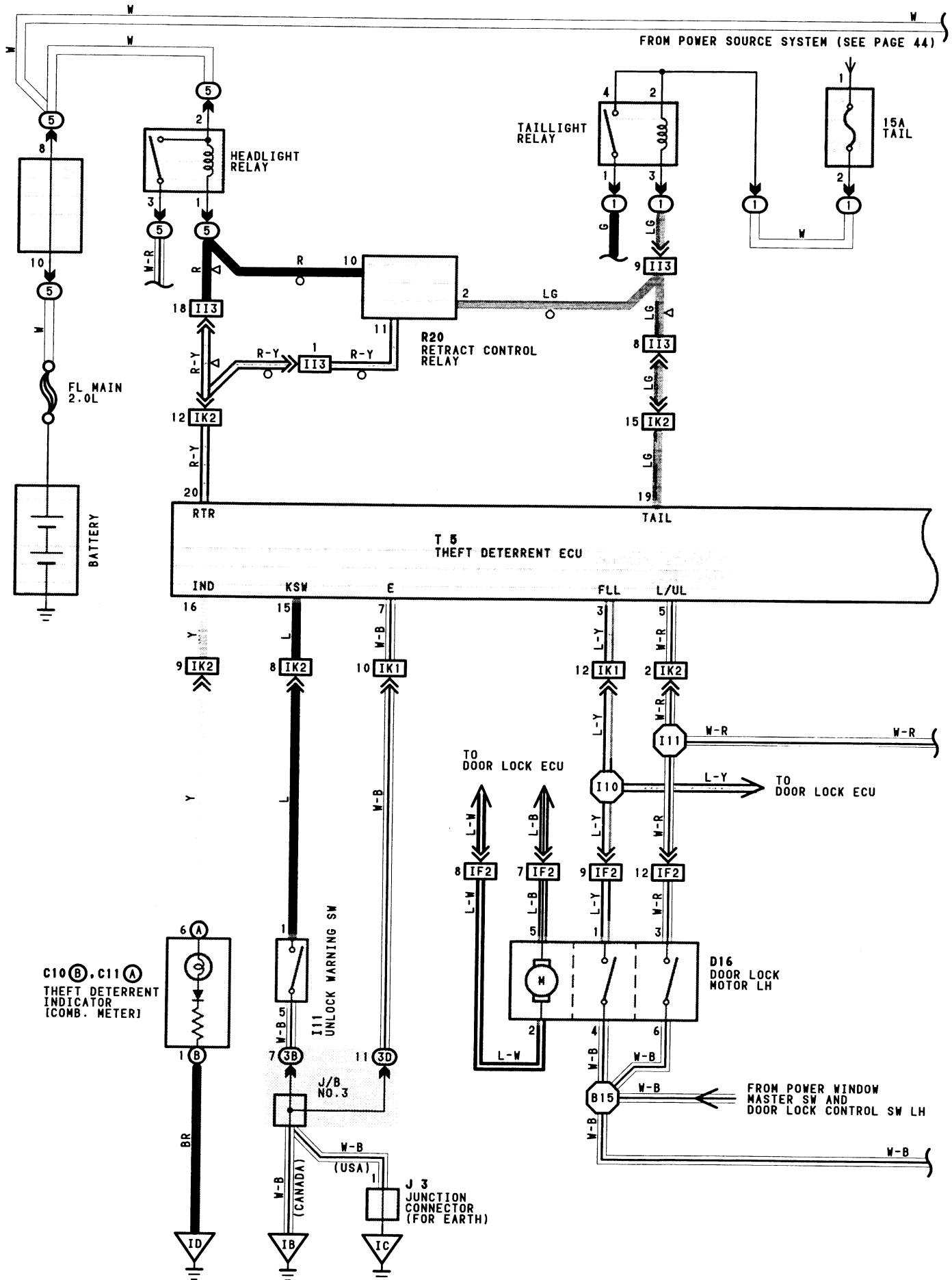

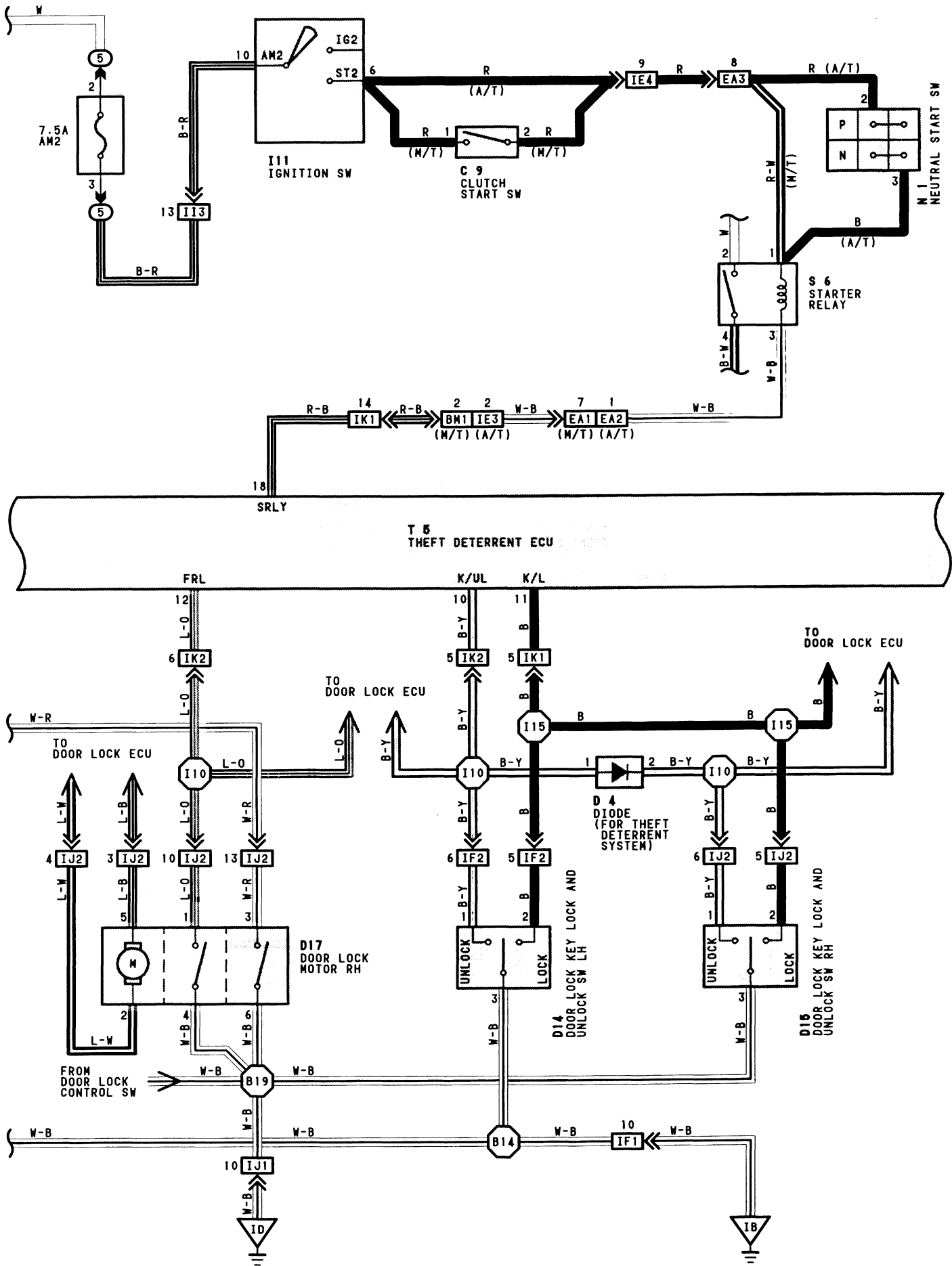



THEFT DETERRENT

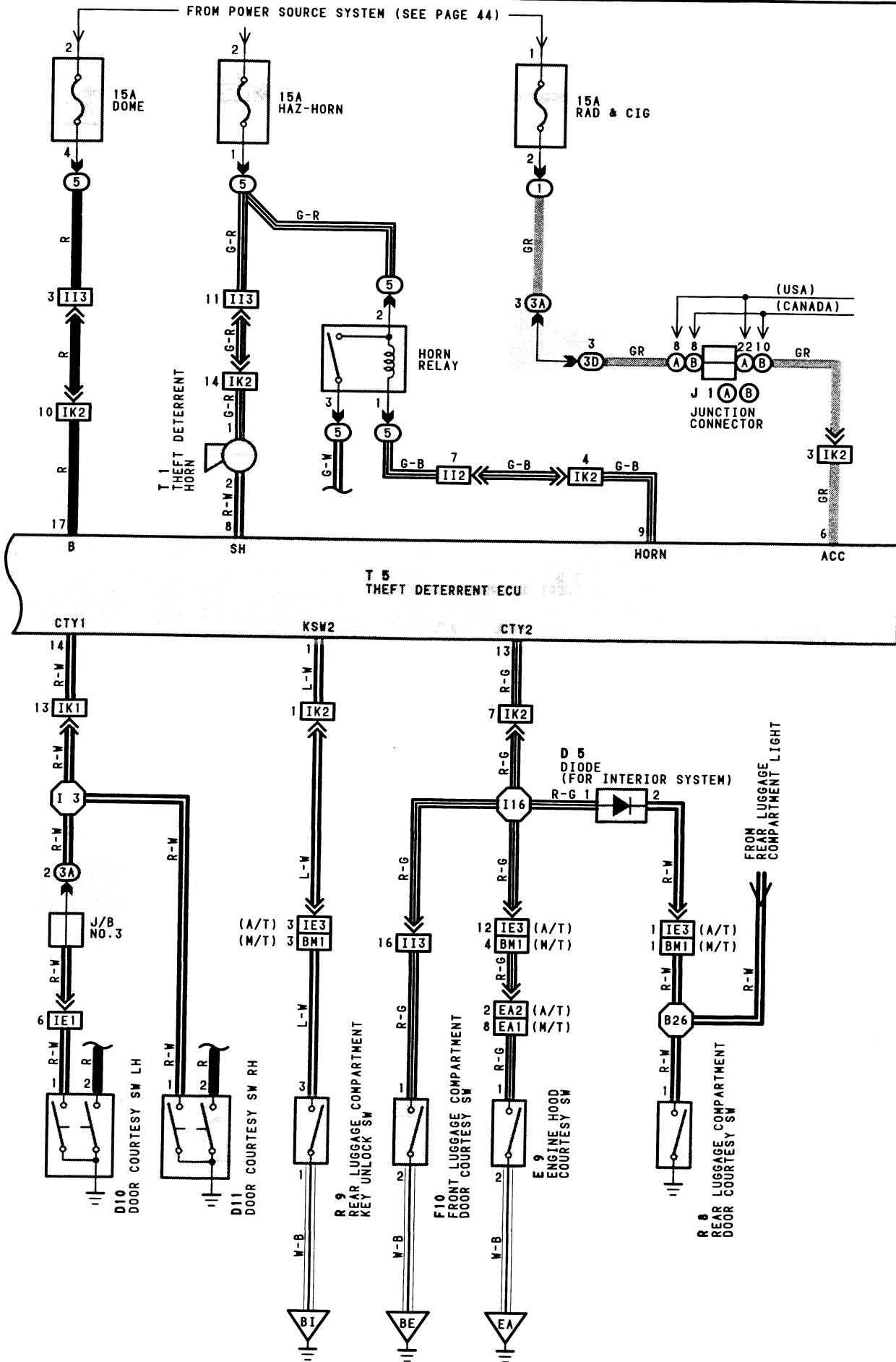

SERVICE HINTS

T 5 THEFT DETERRENT ECU

- 13-GROUND: 0VOLTS WITH ENGINE HOOD OR FRONT OR REAR LUGGAGE COMPARTMENT DOOR OPEN
APPROX. 12VOLTS WITH ENGINE HOOD OR FRONT OR REAR LUGGAGE COMPARTMENT DOOR OPEN
- 16-GROUND: APPROX. 12VOLTS WITHIN 30SECONDS WITH SYSTEM ON
- 10-GROUND: 0VOLTS WITH LH OR RH DOOR UNLOCKED WITH KEY
APPROX. 12VOLTS WITH LH OR RH DOOR EXCEPT UNLOCKED WITH KEY
- 6-GROUND: 12VOLTS WITH IGNITION SW AT ACC OR ON POSITION
0VOLTS WITH IGNITION SW OFF
- 7-GROUND: ALWAYS CONTINUITY
- 14-GROUND: 0VOLTS WITH LH OR RH DOOR OPEN
APPROX. 12VOLTS WITH LH OR RH DOOR CLOSED
- 5-GROUND: 0VOLTS WITH LH OR RH DOOR LOCK LEVER PULLED
APPROX. 12VOLTS WITH LH OR RH DOOR LOCK LEVER PULLED
- 1-GROUND: 0VOLTS WITH REAR LUGGAGE COMPARTMENT DOOR UNLOCKED WITH THE KEY
12VOLTS WITH REAR LUGGAGE COMPARTMENT DOOR LOCKED WITH THE KEY
- 11-GROUND: 0VOLTS WITH LH OR RH DOOR LOCKED WITH THE KEY
APPROX. 12VOLTS WITH LH OR RH DOOR EXCEPT LOCKED WITH THE KEY
- 18-GROUND: APPROX. 12VOLTS WITH SYSTEM ON AND IGNITION SW ST POSITION
0VOLTS WITH SYSTEM OPERATED
- 17-GROUND: ALWAYS APPROX. 12VOLTS

D10, D11 DOOR COURTESY SW

- 1-GROUND: CLOSED WITH LH OR RH DOOR OPEN

D14, D15 DOOR LOCK KEY LOCK AND UNLOCK SW

- 1-3 : CLOSED WITH KEY CYLINDER UNLOCKED WITH KEY
- 2-3 : CLOSED WITH KEY CYLINDER LOCKED WITH KEY

D16, D17 DOOR LOCK MOTOR

- 3-6 : CLOSED WITH DOOR LOCK LEVER PULLED

E 9 ENGINE HOOD COURTESY SW

- 1-2 : CLOSED WITH ENGINE HOOD OPEN

R 8 REAR LUGGAGE COMPARTMENT DOOR COURTESY SW

- 1-GROUND: CLOSED WITH REAR LUGGAGE COMPARTMENT DOOR OPEN

R 9 REAR LUGGAGE COMPARTMENT KEY UNLOCK SW

- 1-2 : CLOSED WITH REAR LUGGAGE COMPARTMENT DOOR UNLOCKED WITH THE KEY

○ : PARTS LOCATION

CODE	SEE PAGE	CODE	SEE PAGE	CODE	SEE PAGE
C 9	22	D15	23	J 3	22
C10	B 22	D16	23	N 1	20
C11	A 22	D17	23	R 8	23
D 4	22	E 9	20(5S-FE), 21(3S-GTE)	R 9	23
D 5	22	F10	23	R20	23
D10	23	I11	22	S 6	20(5S-FE), 21(3S-GTE)
D11	23	J 1	A 22	T 1	20(5S-FE), 21(3S-GTE)
D14	23		B 22	T 5	23

○ : RELAY BLOCKS

CODE	SEE PAGE	RELAY BLOCKS (RELAY BLOCK LOCATION)
1	18	R/B NO.1 (LEFT KICK PANEL)
5	17	R/B NO.5 (FRONT LUGGAGE COMPARTMENT RIGHT)

○ : JUNCTION BLOCK AND WIRE HARNESS CONNECTOR

CODE	SEE PAGE	JUNCTION BLOCK AND WIRE HARNESS (CONNECTOR LOCATION)
3A	19	COWL WIRE AND J/B NO.3 (BEHIND COMBINATION METER).
3B		
3D		

THEFT DETERRENT

☐ : CONNECTOR JOINING WIRE HARNESS AND WIRE HARNESS

CODE	SEE PAGE	JOINING WIRE HARNESS AND WIRE HARNESS (CONNECTOR LOCATION)
EA1	24(5S-FE)	ENGINE WIRE AND ENGINE ROOM MAIN WIRE (REAR LUGGAGE COMPARTMENT LEFT)
	26(3S-GTE)	
EA2	24(5S-FE)	
EA3	24(5S-FE)	ENGINE WIRE AND ENGINE ROOM MAIN WIRE (R/B NO.2 INNER)
	26(3S-GTE)	
IE3	28	ENGINE ROOM MAIN WIRE AND COWL WIRE (LEFT KICK PANEL)
IE4		
IF1	28	COWL WIRE AND FRONT DOOR LH WIRE (LEFT KICK PANEL)
IF2	28	FRONT DOOR LH WIRE AND COWL WIRE (LEFT KICK PANEL)
II2	30	LUGGAGE ROOM WIRE AND COWL WIRE (RIGHT KICK PANEL)
II3	30	COWL WIRE AND LUGGAGE ROOM WIRE (RIGHT KICK PANEL)
IJ1	30	COWL WIRE AND FRONT DOOR RH WIRE (RIGHT KICK PANEL)
IJ2	30	FRONT DOOR RH WIRE AND COWL WIRE (RIGHT KICK PANEL)
IK1	30	FLOOR WIRE AND COWL WIRE (RIGHT KICK PANEL)
IK2		
BM1	32	ENGINE ROOM MAIN WIRE AND COWL WIRE (ROOM PARTITION BOARD LEFT)

▽ : GROUND POINTS

CODE	SEE PAGE	GROUND POINTS LOCATION
EA	24(5S-FE)	INTAKE MANIFOLD
	26(3S-GTE)	
IB	28	LEFT KICK PANEL
IC	28	INSTRUMENT PANEL BRACE LH
ID	28	RIGHT KICK PANEL
BE	32	FRONT RIGHT FENDER
BI	32	BACK PANEL CENTER

○ : SPLICE POINTS

CODE	SEE PAGE	WIRE HARNESS WITH SPLICE POINTS	CODE	SEE PAGE	WIRE HARNESS WITH SPLICE POINTS
I 3	30	COWL WIRE	B14	32	FRONT DOOR RH WIRE
I10			B15		
I11			B19	FRONT DOOR LH WIRE	
I15			B26	ENGINE ROOM MAIN WIRE	
I16					

C 9

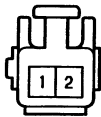

C10 (B) BLUE

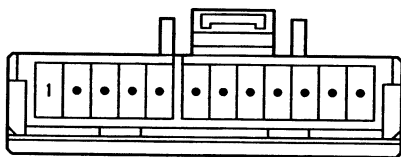

C11 (A)

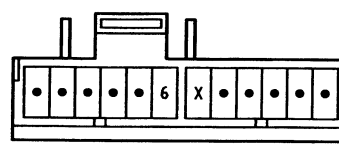

D 4, D 5 BLACK



D10, D11



D14, D15 GRAY



D16, D17

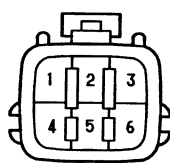

E 9, F10 BLACK



I11 BLACK

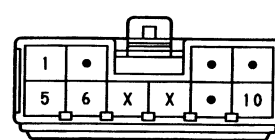

J 1 (A)

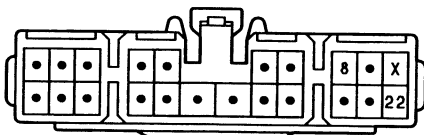

J 1 (B)

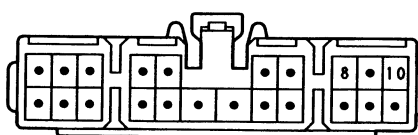

J 3

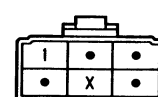



REAR WINDOW DEFOGGER

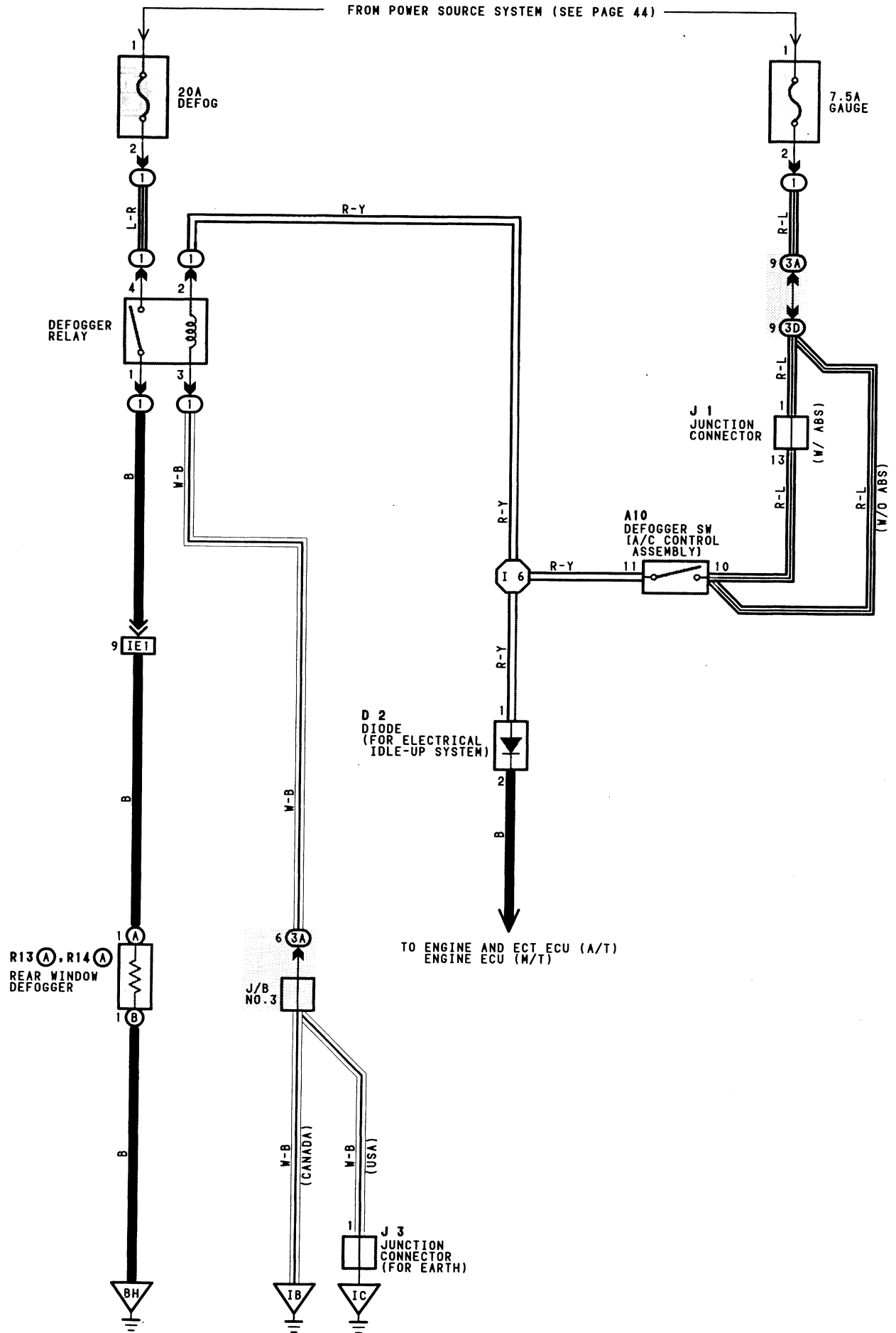

SERVICE HINTS

DEFOGGER RELAY

4-1:CLOSED WITH IGNITION SW ON AND DEFOGGER SW ON
A10 DEFOGGER SW (A/C CONTROL ASSEMBLY)
 10-GROUND:APPROX. 12VOLTS WITH IGNITION SW AT ON POSITION
 10-11 :CLOSED WITH DEFOGGER SW ON

○ : PARTS LOCATION

CODE	SEE PAGE	CODE	SEE PAGE	CODE	SEE PAGE
A10	22	J 1	22	R13	A 23
D 2	22	J 3	22	R14	B 23

○ : RELAY BLOCKS

CODE	SEE PAGE	RELAY BLOCKS (RELAY BLOCK LOCATION)
1	18	R/B NO.1 (LEFT KICK PANEL)

○ : JUNCTION BLOCK AND WIRE HARNESS CONNECTOR

CODE	SEE PAGE	JUNCTION BLOCK AND WIRE HARNESS (CONNECTOR LOCATION)
3A 3D	19	COWL WIRE AND J/B NO.3 (BEHIND COMBINATION METER)

□ : CONNECTOR JOINING WIRE HARNESS AND WIRE HARNESS

CODE	SEE PAGE	JOINING WIRE HARNESS AND WIRE HARNESS (CONNECTOR LOCATION)
IE1	28	ENGINE ROOM MAIN WIRE AND COWL WIRE (LEFT KICK PANEL)

▽ : GROUND POINTS

CODE	SEE PAGE	GROUND POINTS LOCATION
IB	28	LEFT KICK PANEL
IC	28	INSTRUMENT PANEL BRACE LH
BH	32	UNDER THE RIGHT REAR PILLAR

○ : SPLICE POINTS

CODE	SEE PAGE	WIRE HARNESS WITH SPLICE POINTS	CODE	SEE PAGE	WIRE HARNESS WITH SPLICE POINTS
I 6	30	COWL WIRE			

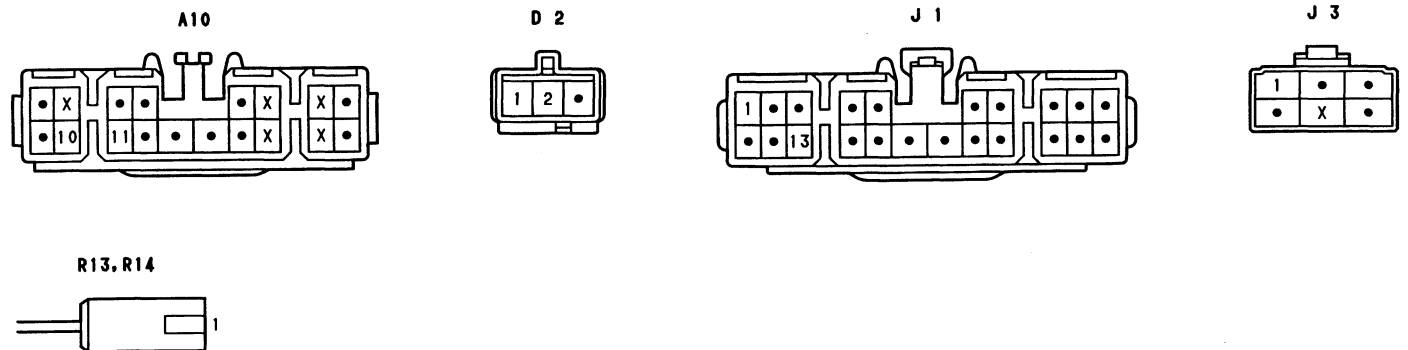

SYSTEM OUTLINE

WHEN THE IGNITION SW IS TURNED TO ACC POSITION THE CURRENT FROM THE RAD & CIG FUSE FLOWS TO TERMINAL 3 OF THE SHIFT LOCK ECU. IN THE ON POSITION, THE CURRENT FROM THE ECU-IG FUSE FLOWS TO TERMINAL 4 OF THE ECU.

1. SHIFT LOCK MECHANISM

WITH THE IGNITION SW ON, WHEN A SIGNAL THAT THE BRAKE PEDAL IS DEPRESSED (STOP LIGHT SW ON) AND A SIGNAL THAT THE SHIFT LEVER IS PUT IN "P" RANGE (CONTINUITY BETWEEN P1 AND P OF THE SHIFT POSITION SW) IS INPUT TO THE ECU. THE ECU OPERATES AND CURRENT FLOWS FROM TERMINAL 4 OF THE ECU → TERMINAL SL+ OF THE SHIFT LOCK SOLENOID → SOLENOID → TERMINAL SL- → TERMINAL 1 OF THE ECU → GROUND. THIS CAUSES THE SHIFT LOCK SOLENOID TO TURN ON (PLATE STOPPER DISENGAGES) AND THE SHIFT LEVER CAN SHIFT INTO OTHER RANGE THAN THE "P" RANGE.

2. KEY INTER LOCK MECHANISM

WITH THE IGNITION SW IN ON OR ACC POSITION, WHEN THE SHIFT LEVER IS PUT IN "P" RANGE (NO CONTINUITY BETWEEN P2 AND P OF LOCK CONTROL SW). THE CURRENT FLOWING FROM TERMINAL 2 OF THE ECU → KEY INTER LOCK SOLENOID IS CUT OFF. THIS CAUSES THE KEY INTER LOCK SOLENOID TO TURN OFF (LOCK LEVER DISENGAGES FROM LOCK POSITION) AND THE IGNITION KEY CAN BE TURNED FROM ACC TO LOCK POSITION. IF THE IGNITION IS LEFT IN ACC OR ON POSITION WITH THE SHIFT LEVER IN OTHER THAN "P" RANGE, THEN AFTER APPROX. ONE HOUR THE ECU OPERATES TO RERELEASE THE LOCK.

SERVICE HINTS

S 7 SHIFT LOCK ECU

3-GROUND: APPROX. 12VOLTS WITH IGNITION SW AT ACC OR ON POSITION
 4-GROUND: APPROX. 12VOLTS WITH IGNITION SW AT ON POSITION
 1-GROUND: ALWAYS CONTINUITY
 5-GROUND: APPROX. 12VOLTS WITH BRAKE PEDAL DEPRESSED

○ : PARTS LOCATION

CODE	SEE PAGE	CODE	SEE PAGE	CODE	SEE PAGE
J 1	22	K 2	22	S 9	A 22
J 3	22	S 7	22		B 22

○ : RELAY BLOCKS

CODE	SEE PAGE	RELAY BLOCKS (RELAY BLOCK LOCATION)
1	18	R/B NO.1 (LEFT KICK PANEL)
2	18	R/B NO.2 (ENGINE COMPARTMENT LEFT)

○ : JUNCTION BLOCK AND WIRE HARNESS CONNECTOR

CODE	SEE PAGE	JUNCTION BLOCK AND WIRE HARNESS (CONNECTOR LOCATION)
3A	19	COWL WIRE AND J/B NO.3 (BEHIND COMBINATION METER)
3D		

□ : CONNECTOR JOINING WIRE HARNESS AND WIRE HARNESS

CODE	SEE PAGE	JOINING WIRE HARNESS AND WIRE HARNESS (CONNECTOR LOCATION)
IE3	28	ENGINE ROOM MAIN WIRE AND COWL WIRE (LEFT KICK PANEL)

▽ : GROUND POINTS

CODE	SEE PAGE	GROUND POINTS LOCATION
IC	28	INSTRUMENT PANEL BRACE LH

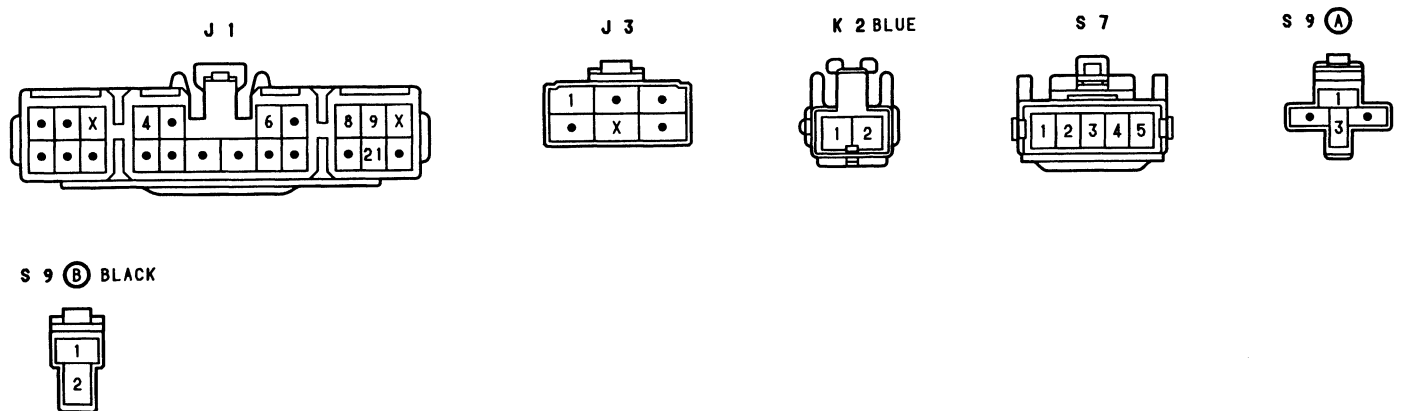



ABS (ANTI-LOCK BRAKE SYSTEM)

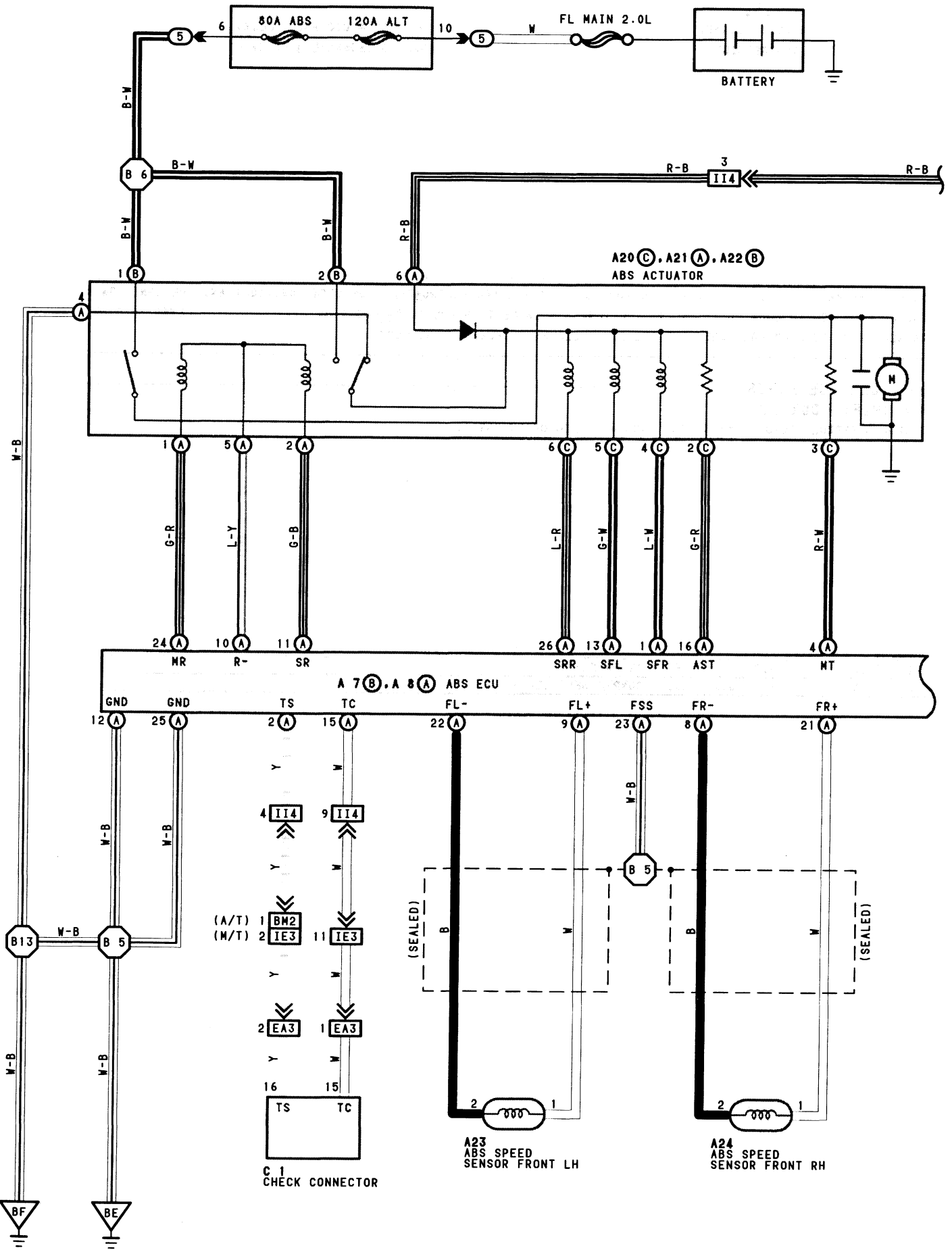

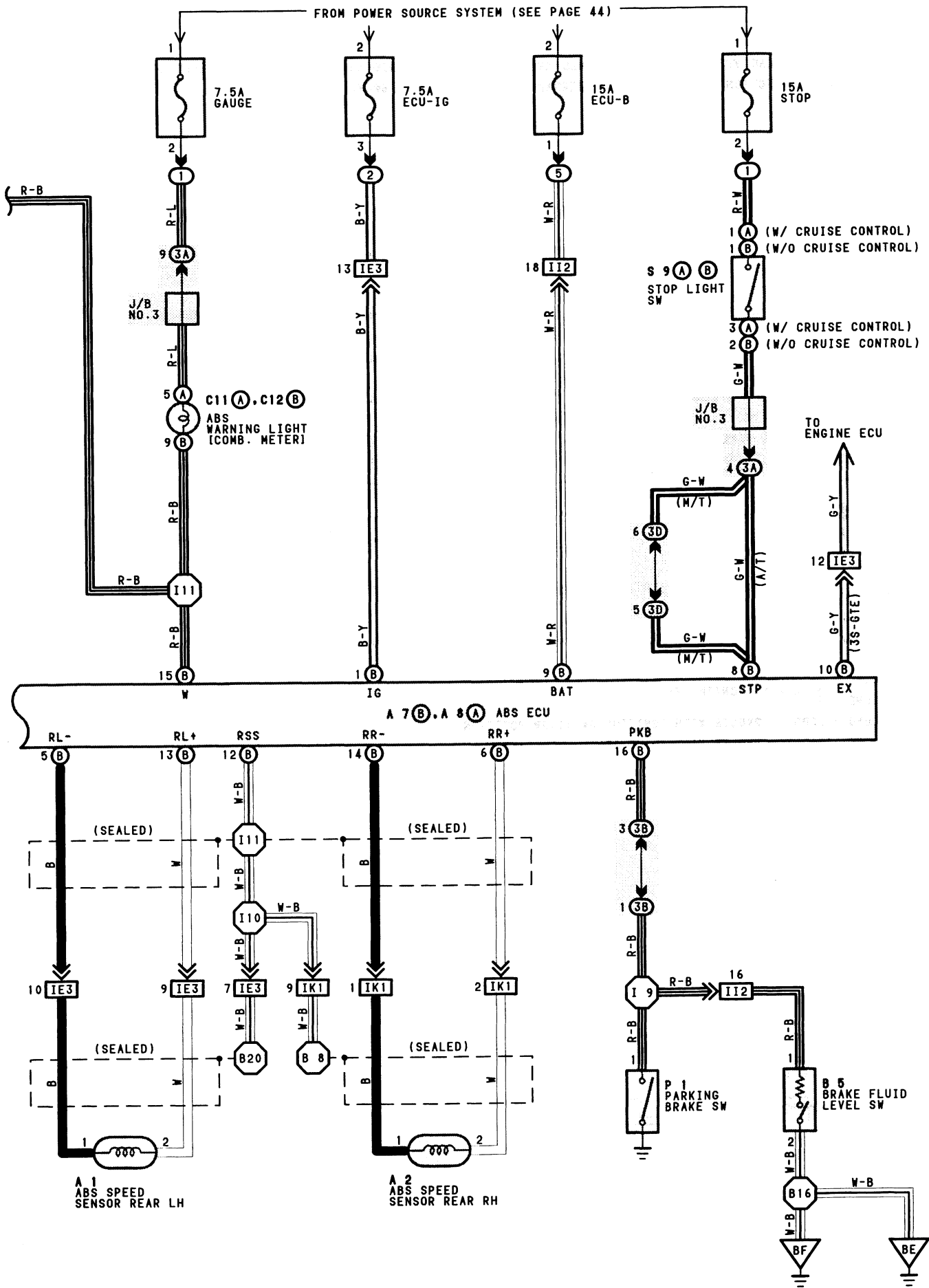



ABS(ANTI-LOCK BRAKE SYSTEM)

SYSTEM OUTLINE

THIS SYSTEM CONTROLS THE RESPECTIVE BRAKE FLUID PRESSURES ACTING ON THE DISC BRAKE CYLINDERS OF THE RIGHT FRONT WHEEL, LEFT FRONT WHEEL AND REAR WHEELS WHEN THE BRAKES ARE APPLIED IN A PANIC STOP SO THAT THE WHEELS DO NOT LOCK. THIS RESULTS IN IMPROVED DIRECTIONAL STABILITY AND STEERABILITY DURING PANIC BRAKING.

1. INPUT SIGNALS

(1) SPEED SENSOR SIGNAL

THE SPEED OF THE WHEELS IS DETECTED AND INPUT TO TERMINALS FL+, FR+, RL+ AND RR+ OF THE ABS ECU.

(2) STOP LIGHT SW SIGNAL

A SIGNAL IS INPUT TO TERMINAL STP OF THE ABS ECU WHEN BRAKE PEDAL IS OPERATED.

(3) PARKING BRAKE SW SIGNAL

A SIGNAL IS INPUT TO TERMINAL PKB OF THE ABS ECU WHEN THE PARKING BRAKE IS OPERATED.

2. SYSTEM OPERATION

DURING SUDDEN BRAKING THE ABS ECU WHICH HAS SIGNALS INPUT FROM EACH SENSOR, CONTROLS THE CURRENT FLOWING TO THE SOLENOID INSIDE THE ACTUATOR AND LETS THE HYDRAULIC PRESSURE ACTING ON EACH WHEEL CYLINDER ESCAPE TO THE RESERVOIR. THE PUMP INSIDE THE ACTUATOR IS ALSO OPERATING AT THIS TIME AND IT RETURNS THE BRAKE FLUID FROM THE RESERVOIR TO THE MASTER CYLINDER. THUS PREVENTING LOCKING OF THE VEHICLE WHEELS.

IF THE ECU JUDGES THAT THE HYDRAULIC PRESSURE ACTING ON THE WHEEL CYLINDER IS INSUFFICIENT, THE CURRENT ACTING ON THE SOLENOID IS CONTROLLED AND THE HYDRAULIC PRESSURE IS INCREASED. HOLDING OF THE HYDRAULIC PRESSURE IS ALSO CONTROLLED BY THE COMPUTER, BY THE SAME METHOD AS ABOVE, BY REPEATED PRESSURE REDUCTION, HOLDING AND INCREASE ARE REPLATED TO MAINTAIN VEHICLE STABILITY AND TO IMPROVE STEERABILITY DURING SUDDEN BRAKING.

SERVICE HINTS

A 7(A), A 8(B) ABS ECU

(CONNECT THE ECU CONNECTOR)

(A) 2 - GROUND : } APPROX. 12VOLTS WITH IGNITION SW AT ON POSITION AND CHECK CONNECTOR T8-E1 NOT CONNECTED
(A) 15 - GROUND : }

(A) 11 - GROUND, (A) 13 - GROUND : }
(A) 14 - GROUND, (A) 16 - GROUND : } APPROX. 12VOLTS WITH IGNITION SW AT ON POSITION ABS WARNING LIGHT GOES OFF
(A) 26 - GROUND, (B) 15 - GROUND : }

(A) 12 - GROUND : } ALWAYS CONTINUITY
(A) 25 - GROUND : }

(B) 1 - GROUND : APPROX. 12VOLTS WITH IGNITION SW AT ON POSITION

(B) 8 - GROUND : APPROX. 12VOLTS WITH BRAKE PEDAL DEPRESSED

(B) 9 - GROUND : ALWAYS APPROX. 12VOLTS

(B) 16 - GROUND : APPROX. 12VOLTS WITH ENGINE RUNNING AND PARKING BRAKE LEVER RETURNED

(DISCONNECT THE ECU CONNECTOR)

(A) 1 - (A) 16 : }
(A) 13 - (A) 16 : } APPROX. 6Ω
(A) 14 - (A) 16 : }

(A) 16 - (A) 26 : }
(A) 8 - (A) 21 : } APPROX. 0.8 - 1.3Ω
(A) 9 - (A) 22 : }

(A) 10 - (A) 11 : APPROX. 60 - 100Ω

(A) 10 - (A) 24 : APPROX. 50 - 80Ω

(B) 5 - (B) 13 : } APPROX. 1.1 - 1.5KΩ
(B) 6 - (B) 14 : }

A 1 GRAY



A 2 GRAY



A 7 (B) DARK GRAY

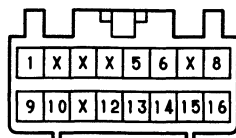

A 8 (A) DARK GRAY

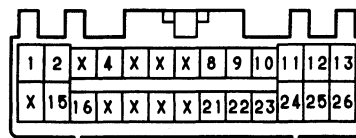

A20 (C) GRAY

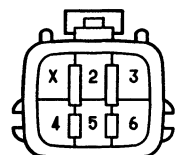

○ : PARTS LOCATION

CODE	SEE PAGE	CODE	SEE PAGE	CODE	SEE PAGE
A 1	20(5S-FE), 21(3S-GTE)	A22	B 23	C12	B 22
A 2	20(5S-FE), 21(3S-GTE)	A23	23	P 1	22
A 7	B 22	A24	23	S 9	A 22
A 8	A 22	B 5	23		B 22
A20	C 23	C 1	20(5S-FE), 21(3S-GTE)		
A21	A 23	C11	A 22		

○ : RELAY BLOCKS

CODE	SEE PAGE	RELAY BLOCKS (RELAY BLOCK LOCATION)
1	18	R/B NO.1 (LEFT KICK PANEL)
2		R/B NO.2 (ENGINE COMPARTMENT LEFT)
5	17	R/B NO.5 (FRONT LUGGAGE COMPARTMENT RIGHT)

○ : JUNCTION BLOCK AND WIRE HARNESS CONNECTOR

CODE	SEE PAGE	JUNCTION BLOCK AND WIRE HARNESS (CONNECTOR LOCATION)
3A	19	COWL WIRE AND J/B NO.3 (BEHIND COMBINATION METER)
3B		
3D		

□ : CONNECTOR JOINING WIRE HARNESS AND WIRE HARNESS

CODE	SEE PAGE	JOINING WIRE HARNESS AND WIRE HARNESS (CONNECTOR LOCATION)
EA3	24(5S-FE)	ENGINE WIRE AND ENGINE ROOM MAIN WIRE (R/B NO.2 INNER)
	26(3S-GTE)	
IE3	28	ENGINE ROOM MAIN WIRE AND COWL WIRE (LEFT KICK PANEL)
II2	30	LUGGAGE ROOM WIRE AND COWL WIRE (RIGHT KICK PANEL)
II4	30	COWL WIRE AND LUGGAGE ROOM WIRE (RIGHT KICK PANEL)
IK1	30	FLOOR WIRE AND COWL WIRE (RIGHT KICK PANEL)
BM2	32	COWL WIRE AND ENGINE ROOM MAIN WIRE (ROOM PARTITION BOARD LEFT)

▽ : GROUND POINTS

CODE	SEE PAGE	GROUND POINTS LOCATION
BE	32	FRONT RIGHT FENDER
BF	32	FRONT LEFT FENDER

○ : SPLICE POINTS

CODE	SEE PAGE	WIRE HARNESS WITH SPLICE POINTS	CODE	SEE PAGE	WIRE HARNESS WITH SPLICE POINTS
I 9	30	COWL WIRE	B 8	32	FLOOR WIRE
II0			B13	32	LUGGAGE ROOM WIRE
II1					
B 5	32	LUGGAGE ROOM WIRE	B20	32	ENGINE ROOM MAIN WIRE
B 6					

A21 (A) GRAY

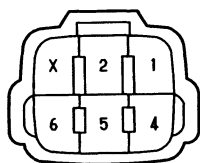

A22 (B) GRAY

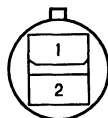

A23, A24 GRAY



B 5 BLACK



C 1 DARK GRAY

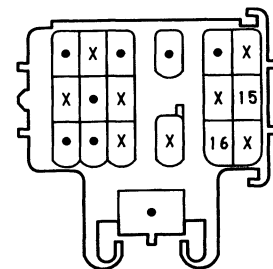

C11 (A)

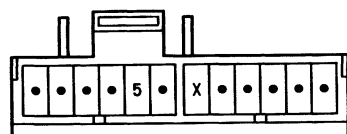

C12 (B) GRAY

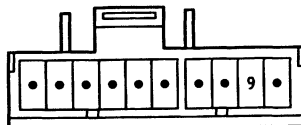

P 1



S 9 (A) BLACK



S 9 (B)





C 1 DARK GRAY

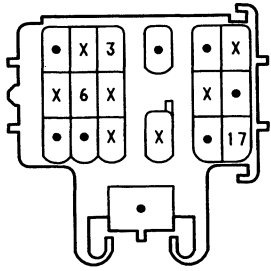

C10 (B) BLUE

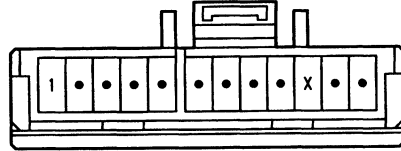

C11 (A)

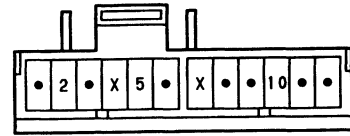

C13

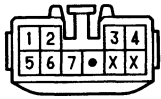

C17

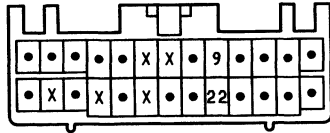

E 1 BLACK



E 3 GREEN



E 6 (A) DARK GRAY

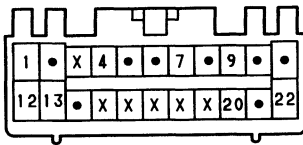

E 7 (C) DARK GRAY

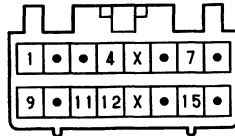

E 8 (B) DARK GRAY

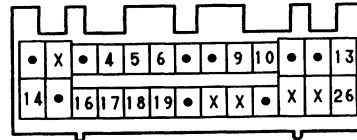

I 1 GRAY



J 3

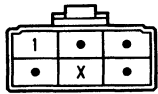

N 1 GRAY

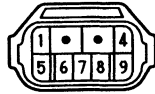

O 4



S 2 GRAY



S 9 (A)

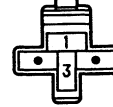

S 9 (B) BLACK

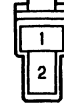

T 2 BLACK



SYSTEM OUTLINE

PREVIOUS AUTOMATIC TRANSMISSIONS HAVE SELECTED EACH GEAR SHIFT USING MECHANICALLY CONTROLLED THROTTLE HYDRAULIC PRESSURE, GOVERNOR HYDRAULIC PRESSURE AND LOCK-UP HYDRAULIC PRESSURE. THE ECT, HOWEVER, ELECTRICALLY CONTROLS THE LINE PRESSURE AND LOCK-UP PRESSURE ETC., THROUGH THE SOLENOID VALVE. ECT ECU CONTROL OF THE SOLENOID VALVE BASED ON THE INPUT SIGNALS FROM EACH SENSOR MAKES SMOOTH DRIVING POSSIBLE BY SHIFT SELECTION FOR EACH GEAR WHICH IS MOST APPROPRIATE TO THE DRIVING CONDITIONS AT THAT TIME.

1. GEAR SHIFT OPERATION

DURING DRIVING, THE ECU SELECTS THE SHIFT FOR EACH GEAR WHICH IS MOST APPROPRIATE TO THE DRIVING CONDITIONS, BASED ON INPUT SIGNALS FROM THE EFI WATER TEMP. SENSOR TO TERMINAL THW OF THE ECU, AND ALSO THE INPUT SIGNALS TO TERMINAL SP2 OF THE ECU FROM THE SPEED SENSOR DEVOTED TO THE ECT. CURRENT IS THEN OUTPUT TO THE ECT SOLENOIDS. WHEN SHIFTING TO 1ST SPEED, CURRENT FLOWS FROM TERMINAL S1 OF THE ECU → TERMINAL 3 OF THE ECT SOLENOIDS → GROUND, AND CONTINUITY TO THE NO.1 SOLENOID CAUSES THE SHIFT.

FOR 2ND SPEED, CURRENT FLOWS FROM TERMINAL S1 OF THE ECU → TERMINAL 3 OF THE ECT SOLENOIDS → GROUND, AND FROM TERMINAL S2 OF THE ECU → TERMINAL 1 OF THE ECT SOLENOIDS → GROUND, AND CONTINUITY TO SOLENOIDS NO.1 AND NO.2 CAUSES THE SHIFT.

FOR 3RD SPEED, THERE IS NO CONTINUITY TO NO.1 SOLENOID, ONLY TO NO.2, CAUSING THE SHIFT.

SHIFTING INTO 4TH SPEED (OVERDRIVE) TAKES PLACE WHEN THERE IS NO CONTINUITY TO EITHER NO.1 OR NO.2 SOLENOID.

2. LOCK-UP OPERATION

WHEN THE ECT ECU JUDGES FROM EACH SIGNAL THAT LOCK-UP OPERATION CONDITIONS HAVE BEEN MET, CURRENT FLOWS FROM TERMINAL SL OF THE ECT ECU → TERMINAL 2 OF THE ECT SOLENOIDS → GROUND, CAUSING CONTINUITY TO THE LOCK-UP SOLENOID AND CAUSING LOCK-UP OPERATION.

3. STOP LIGHT SW CIRCUIT

IF THE BRAKE PEDAL IS DEPRESSED (STOP LIGHT SW ON) WHEN DRIVING IN LOCK-UP CONDITION, A SIGNAL IS INPUT TO TERMINAL B/K OF THE ECU, THE ECU OPERATES AND CONTINUITY TO THE LOCK-UP SOLENOID IS CUT.

4. OVERDRIVE CIRCUIT

- O/D MAIN SW ON

WHEN THE O/D MAIN SW IS TURNED ON (O/D OFF INDICATOR LIGHT TURNS OFF), A SIGNAL IS INPUT TO TERMINAL OD2 OF THE ECU AND ECU OPERATION CAUSES GEAR SHIFT WHEN THE CONDITIONS FOR OVERDRIVE ARE MET.

- O/D MAIN SW OFF

WHEN THE OVERDRIVE SW IS TURNED TO OFF, THE CURRENT FLOWING THROUGH THE O/D OFF INDICATOR LIGHT FLOWS THROUGH THE O/D MAIN SW TO GROUND. CAUSING THE INDICATOR LIGHT TO LIGHT UP. AT THE SAME TIME, A SIGNAL IS INPUT TO TERMINAL OD2 OF THE ECU AND ECU OPERATION PREVENTS SHIFT INTO OVERDRIVE.

SERVICE HINTS

E 6 (A).E 7 (C).E 8 (B) ENGINE AND ECT ECU

- (A) 4-(B) 14:10-14VOLTS (BRAKE PEDAL IS DEPRESSED)
UNDER 1VOLTS (BRAKE PEDAL IS DEPRESSED)
- (C) 4-(B) 14:0.1-1.1VOLTS (IGNITION SW ON AND COOLANT TEMP. 80°C(176°C))
- (C) 12-(C) 9:8-14VOLTS (IGNITION SW ON AND THROTTLE VALVE FULLY OPEN)
- (C) 11-(C) 9:0.8-1.2VOLTS (IGNITION SW ON AND THROTTLE VALVE FULLY CLOSED)
3.2-4.2VOLTS (IGNITION SW ON AND THROTTLE VALVE FULLY OPEN)
- (C) 1-(C) 9:4.5-5.5VOLTS (IGNITION SW ON)
- (A) 20-(B) 14:10-14VOLTS (IGNITION SW ON)
- (A) 7-(B) 14:10-14VOLTS (IGNITION SW ON AND O/D MAIN SW TURNED ON)
UNDER 1VOLTS (IGNITION SW ON AND O/D MAIN SW TURNED OFF)
- (A) 9-(B) 14:UNDER 1VOLTS (IGNITION SW ON, CRUISE CONTROL SW OFF AND STARTING STILL)
0 ↔ 10-14VOLTS REPEAT (IGNITION SW ON, CRUISE CONTROL SW OFF AND VEHICLE MOVING)
- (B) 17-(B) 14:UNDER 1VOLTS (IGNITION SW ON AND STARTING STILL)
0 ↔ 4.5-5.5VOLTS REPEAT (IGNITION SW ON AND VEHICLE MOVING)
- (A) 22-(B) 14:10-14VOLTS (IGNITION SW ON AND NEUTRAL START SW P OR N POSITION)
UNDER 1VOLTS (IGNITION SW ON AND EX. NEUTRAL START SW P OR N POSITION)
- (B) 18-(B) 14:10-14VOLTS (IGNITION SW ON AND NEUTRAL START SW 2 POSITION)
UNDER 1VOLTS (IGNITION SW ON AND EX. NEUTRAL START SW 2 POSITION)
- (B) 19-(B) 14:10-14VOLTS (IGNITION SW ON AND NEUTRAL START SW L POSITION)
UNDER 1VOLTS (IGNITION SW ON AND EX. NEUTRAL START SW L POSITION)
- (A) 12, (A) 13-(B) 14:10-14VOLTS (IGNITION SW ON)
- (A) 1-(B) 14:10-14VOLTS (ALL CONDITIONS)

RESISTANCE AT ECU WIRING CONNECTORS

(DISCONNECT WIRING CONNECTOR)

- ⊖ 12-⊖ 9: INFINITY (THROTTLE VALVE OPEN)
2.3K Ω OR LESS (THROTTLE VALVE FULLY CLOSED)
- ⊖ 11-⊖ 9: 3.3-10.0K Ω (THROTTLE VALVE FULLY OPEN)
0.2- 0.8K Ω (THROTTLE VALVE FULLY CLOSED)
- ⊖ 1-⊖ 9: 0.2- 0.4K Ω
- ⊖ 4-⊖ 9: 0.2- 0.4K Ω (COOLANT TEMP. 80°C, 176°F)
- ⊖ 4, ⊖ 5, ⊖ 6-GROUND: 11-15 Ω (ALL CONDITIONS)

○ : PARTS LOCATION

CODE	SEE PAGE	CODE	SEE PAGE	CODE	SEE PAGE
C 1	20(5S-FE)	E 3	20(5S-FE)	N 1	20(5S-FE)
C10	B 22	E 6	A 20(5S-FE)	O 4	22(5S-FE)
C11	A 22	E 7	C 20(5S-FE)	S 2	20(5S-FE)
C13	22(5S-FE)	E 8	B 20(5S-FE)	S 9	A 22
C17	22	I 1	20(5S-FE)		B 22
E 1	20(5S-FE)	J 3	22	T 2	20(5S-FE)

○ : RELAY BLOCKS

CODE	SEE PAGE	RELAY BLOCKS (RELAY BLOCK LOCATION)
1	18	R/B NO.1 (LEFT KICK PANEL)
2	18	R/B NO.2 (ENGINE COMPARTMENT LEFT)

○ : JUNCTION BLOCK AND WIRE HARNESS CONNECTOR

CODE	SEE PAGE	JUNCTION BLOCK AND WIRE HARNESS (CONNECTOR LOCATION)
3A	19	COWL WIRE AND J/B NO.3 (BEHIND COMBINATION METER)
3D		

□ : CONNECTOR JOINING WIRE HARNESS AND WIRE HARNESS

CODE	SEE PAGE	JOINING WIRE HARNESS AND WIRE HARNESS (CONNECTOR LOCATION)
EA2	24(5S-FE)	ENGINE WIRE AND ENGINE ROOM MAIN WIRE (REAR LUGGAGE COMPARTMENT LEFT)
EA3	24(5S-FE)	ENGINE WIRE AND ENGINE ROOM MAIN WIRE (R/B NO.2 INNER)
EB1	24(5S-FE)	ENGINE WIRE AND R/B NO.2 (R/B NO.2 INNER)
IE1	28	ENGINE ROOM MAIN WIRE AND COWL WIRE (LEFT KICK PANEL)
BM2	32	COWL WIRE AND ENGINE ROOM MAIN WIRE (ROOM PARTITION BOARD LEFT)

▽ : GROUND POINTS

CODE	SEE PAGE	GROUND POINTS LOCATION
EA	24(5S-FE)	INTAKE MANIFOLD
IC	28	INSTRUMENT PANEL BRACE LH
ID	28	RIGHT KICK PANEL
BG	32	UNDER THE LEFT CENTER PILLAR
BI	32	BACK PANEL CENTER

○ : SPLICE POINTS

CODE	SEE PAGE	WIRE HARNESS WITH SPLICE POINTS	CODE	SEE PAGE	WIRE HARNESS WITH SPLICE POINTS
E 1	24(5S-FE)	ENGINE ROOM MAIN WIRE	E15	24(5S-FE)	ENGINE WIRE
E 2			I 2	30	COWL WIRE
E11	24(5S-FE)	ENGINE WIRE	I 4		
E14					



CRUISE CONTROL

FROM POWER SOURCE SYSTEM (SEE PAGE 44)

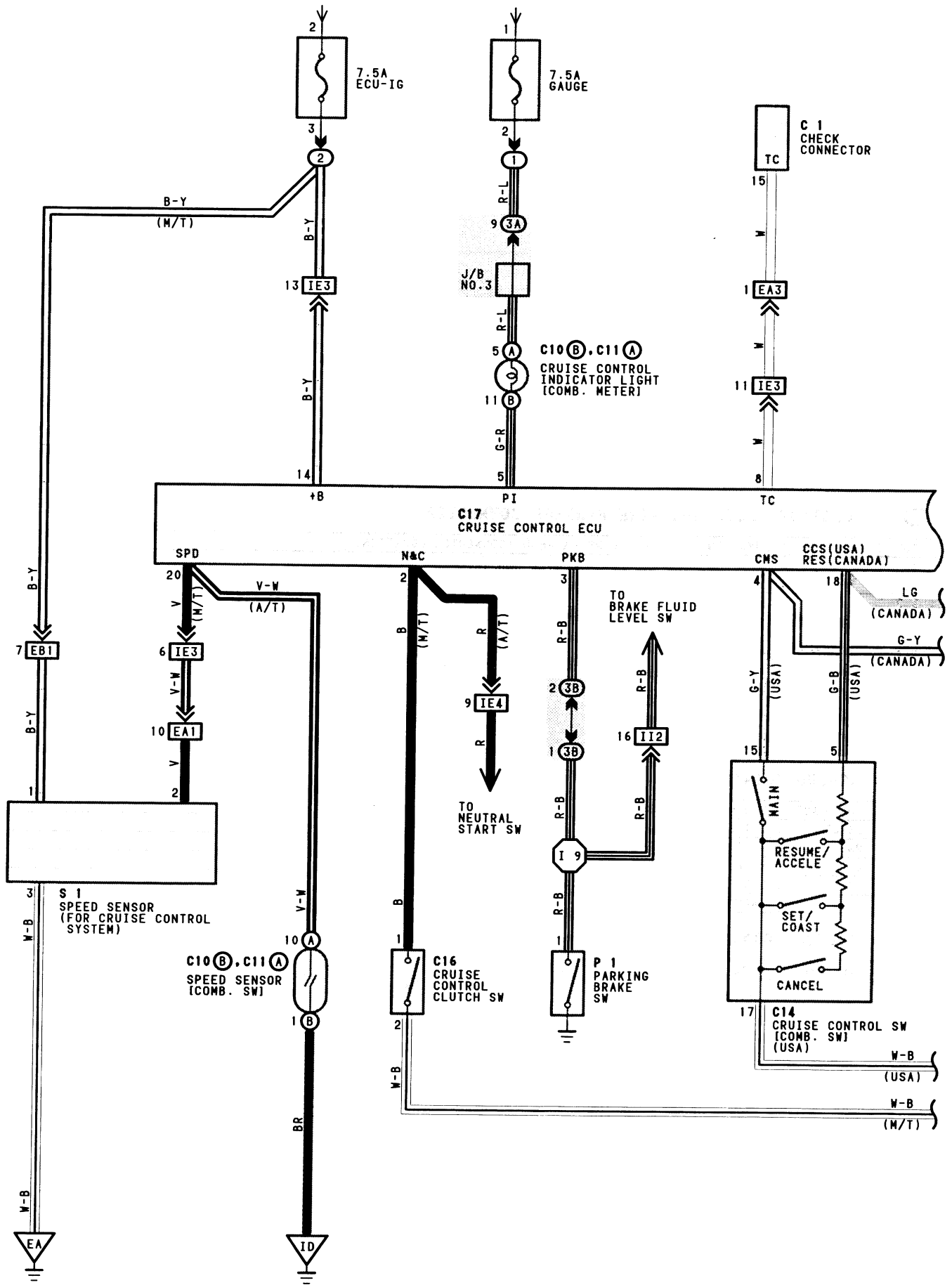

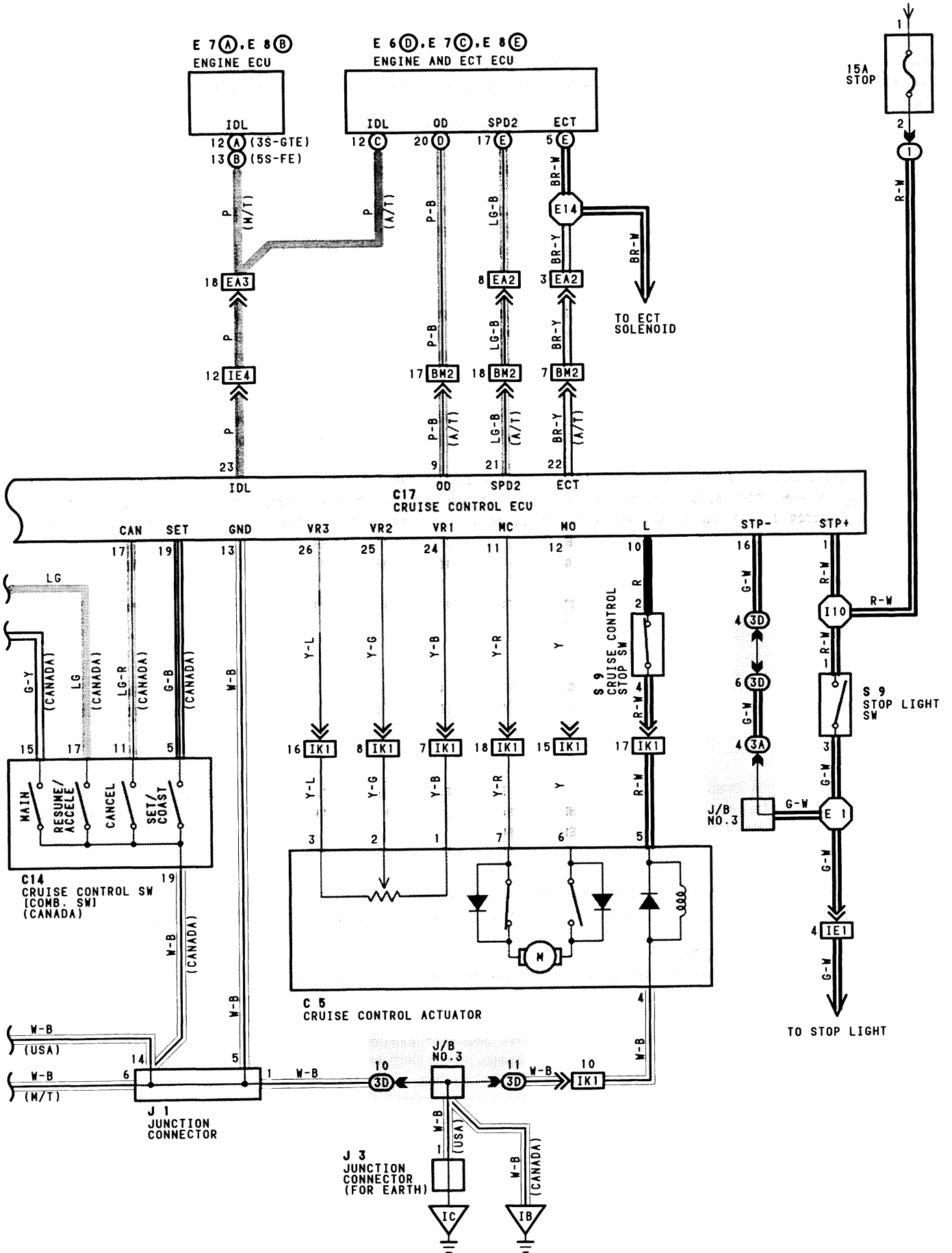



SYSTEM OUTLINE

CURRENT IS APPLIED AT ALL TIMES THROUGH STOP FUSE TO **TERMINAL 1** OF THE CRUISE CONTROL ECU AND **TERMINAL 1** OF STOP LIGHT SWITCH.

WITH THE IGNITION SWITCH TURNED TO ON, THE CURRENT FLOWS THROUGH GAUGE FUSE TO **TERMINAL (A) 5** OF CRUISE CONTROL INDICATOR LIGHT. THE CURRENT THROUGH ECU-IG FUSE FLOWS TO **TERMINAL 14** OF CRUISE CONTROL ECU AND **TERMINAL 1** OF CRUISE CONTROL SPEED SENSOR.

WHEN THE IGNITION SWITCH IS ON AND THE CRUISE CONTROL MAIN SWITCH IS TURNED ON, A SIGNAL IS INPUT FROM **TERMINAL 15** OF CRUISE CONTROL MAIN SWITCH TO **TERMINAL 4** OF CRUISE CONTROL ECU. AS A RESULT, THE CRUISE CONTROL ECU FUNCTIONS AND THE CURRENT TO **TERMINAL 14** OF CRUISE CONTROL ECU TO **TERMINAL 13** OF CRUISE CONTROL ECU → **GROUND**, AND THE CRUISE CONTROL SYSTEM IS IN A CONDITION READY FOR OPERATION.

AT THE SAME TIME, THE CURRENT THROUGH THE GAUGE FUSE FLOWS FROM **TERMINAL (A) 5** OF CRUISE CONTROL INDICATOR LIGHT → **TERMINAL (B) 11** → **TERMINAL 5** OF CRUISE CONTROL ECU → **TERMINAL 13** → TO **GROUND**, CAUSING THE CRUISE CONTROL INDICATOR LIGHT TO LIGHT UP, INDICATING THAT THE CRUISE CONTROL IS READY FOR OPERATION.

1. SET OPERATION

WHEN THE CRUISE CONTROL MAIN SWITCH IS TURNED ON AND THE SET SWITCH IS PUSHED WITH THE VEHICLE SPEED WITHIN THE SET LIMIT (APPROX. 40KM/H, 25MPH TO 200KM/H, 124MPH), A SIGNAL IS INPUT TO **TERMINAL 4** OF THE CRUISE CONTROL ECU AND THE VEHICLE SPEED AT THE TIME THE SET SWITCH IS RELEASED IS MEMORIZED IN THE ECU AS THE SET SPEED.

2. SET SPEED CONTROL

DURING CRUISE CONTROL DRIVING, THE ECU COMPARES THE SET SPEED MEMORIZED IN THE ECU WITH THE ACTUAL VEHICLE SPEED INPUT INTO **TERMINAL 20** AND **21 (A/T)** OF THE CRUISE CONTROL MAIN SWITCH FROM THE SPEED SENSOR, AND CONTROLS THE CRUISE CONTROL ACTUATOR TO MAINTAIN THE SET SPEED.

WHEN THE ACTUAL SPEED IS LOWER THAN THE SET SPEED, THE ECU CAUSES THE CURRENT TO THE CRUISE CONTROL ACTUATOR TO FLOW FROM **TERMINAL 12** → **TERMINAL 6** OF CRUISE CONTROL ACTUATOR → **TERMINAL 7** → **TERMINAL 11** OF CRUISE CONTROL ECU. AS A RESULT, THE MOTOR IN THE CRUISE CONTROL ACTUATOR IS ROTATED TO OPEN THE THROTTLE VALVE AND THE THROTTLE CABLE IS PULLED TO INCREASE THE VEHICLE SPEED. WHEN THE ACTUAL DRIVING SPEED IS HIGHER THAN THE SET SPEED, THE CURRENT TO CRUISE CONTROL ACTUATOR FLOWS FROM **TERMINAL 11** OF ECU → **TERMINAL 7** OF CRUISE CONTROL ACTUATOR → **TERMINAL 6** → **TERMINAL 12** OF CRUISE CONTROL ECU.

THIS CAUSES THE MOTOR IN THE CRUISE CONTROL ACTUATOR TO ROTATE TO CLOSE THE THROTTLE VALVE AND RETURN THE THROTTLE CABLE TO DECREASE THE VEHICLE SPEED.

3. COAST CONTROL

DURING THE CRUISE CONTROL DRIVING, WHILE THE COAST SWITCH IS ON, THE CRUISE CONTROL ACTUATOR RETURNS THE THROTTLE CABLE TO CLOSE THE THROTTLE VALVE AND DECREASE THE DRIVING SPEED. THE VEHICLE SPEED WHEN THE COAST SWITCH IS TURNED OFF IS MEMORIZED AND THE VEHICLE CONTINUES AT THE NEW SET SPEED.

4. ACCEL CONTROL

DURING CRUISE CONTROL DRIVING, WHILE THE ACCEL SWITCH IS TURNED ON, THE CRUISE CONTROL ACTUATOR PULLS THE THROTTLE CABLE TO OPEN THE THROTTLE VALVE AND INCREASE THE DRIVING SPEED. THE VEHICLE SPEED WHEN THE ACCEL SWITCH IS TURNED OFF IS MEMORIZED AND THE VEHICLE CONTINUES AT THE NEW SET SPEED.

5. RESUME CONTROL

UNLESS THE VEHICLE SPEED FALLS BELOW THE MINIMUM SPEED LIMIT (APPROX. 40KM/H) AFTER CANCELING THE SPEED BY THE CANCEL SWITCH, PUSHING THE RESUME SWITCH WILL CAUSE THE VEHICLE TO RESUME THE SPEED SET BEFORE CANCELLATION.

6. MANUAL CANCEL MECHANISM

IF ANY THE FOLLOWING OPERATIONS OCCURS DURING CRUISE CONTROL OPERATION, THE SAFETY MAGNET CLUTCH OF THE ACTUATOR TURNS OFF AND THE MOTOR ROTATES TO CLOSE THE THROTTLE VALVE AND THE CRUISE CONTROL IS RELEASED.

- DEPRESSING THE CLUTCH PEDAL (CRUISE CONTROL CLUTCH SWITCH ON). "SIGNAL INPUT TO **TERMINAL 2** OF ECU" (M/T)
SHIFT LEVER AT "N" RANGE (NEUTRAL START SW ON). "SIGNAL INPUT TO **TERMINAL 2** OF THE ECU" (A/T)
- DEPRESSING THE BRAKE PEDAL (STOP LIGHT SWITCH ON). "SIGNAL INPUT TO **TERMINAL 1** OF ECU"
- PULL UP THE PARKING BRAKE LEVER (PARKING BRAKE SWITCH ON). "SIGNAL INPUT TO **TERMINAL 3** OF ECU"
- PUSH THE CANCEL SWITCH (CANCEL SWITCH ON). "SIGNAL INPUT TO **TERMINAL 18** (USA) OR **17** (CANADA)"

7. AUTO CANCEL FUNCTION

A) IF ANY OF THE FOLLOWING OPERATE CONDITIONS OCCURS DURING CRUISE CONTROL OPERATION, THE SET SPEED IS ERASED, CURRENT FLOW TO SAFETY MAGNETIC CLUTCH IS STOPPED AND THE CRUISE CONTROL IS RELEASED. (MAIN SWITCH TURNS OFF). WHEN THIS OCCURS, THE IGNITION SWITCH MUST BE TURNED OFF ONCE BEFORE THE MAIN SWITCH WILL TURN ON.

- OVER CURRENT TO TRANSISTER DRIVING MOTOR AND/OR SAFETY MAGNETIC CLUTCH.
- WHEN THE CURRENT CONTINUED TO FLOW TO THE MOTOR IN SIDE THE ACTUATOR IN THE THROTTLE VALVE "OPEN" DIRECTION
- OPEN CIRCUIT IN SAFETY MAGNETIC CLUTCH.
- MOMENTARY INTERRUPTION OF VEHICLE SPEED SIGNAL.
- THE RESUME SWITCH IS ALREADY ON WHEN THE MAIN SWITCH IS TURNED ON.
- SHORT CIRCUIT IN CRUISE CONTROL SWITCH.
- MOTOR DOES NOT OPERATE DESPITE THE MOTOR DRIVE SIGNAL BEING OUTPUT.

B) IF ANY OF THE FOLLOWING CONDITIONS OCCUR DURING CRUISE CONTROL OPERATION, THE SET SPEED IS ERASED AND THE CRUISE CONTROL IS RELEASED. (THE POWER OF SAFETY MAGNETIC CLUTCH IS CUT OFF UNTIL THE SET SWITCH IS "ON" AGAIN.)

- WHEN THE VEHICLE SPEED FALLS BELOW THE MINIMUM LIMIT, APPROX. 40KM/H (25MPH)
- WHEN THE VEHICLE SPEED FALLS MORE THAN 16KM/H (10MPH) BELOW THE SET SPEED, E.G. ON AN UPWARD SLOPE.

C) IF ANY OF THE FOLLOWING CONDITIONS OCCURS DURING CRUISE CONTROL OPERATION, THE CRUISE CONTROL IS RELEASED.

- OPEN CIRCUIT FOR TERMINAL 16 OF CRUISE CONTROL ECU AND SPLICE POINT "E 1".

SERVICE HINTS

C 5 CRUISE CONTROL ACTUATOR

- 1-3: APPROX. 2K Ω
- 5-4: APPROX. 38.5 Ω

C14 CRUISE CONTROL SW (COMB. SW) (USA)

- 15-19: CONTINUITY WITH MAIN SW ON
- 5-19: APPROX. 418 Ω WITH CANCEL SW ON
- APPROX. 68 Ω WITH RESUME/ACCEL SW ON
- APPROX. 198 Ω WITH SET/COAST SW ON

C14 CRUISE CONTROL SW (COMB. SW) (CANADA)

- 15-19: CONTINUITY WITH MAIN SW ON
- 11-19: CONTINUITY WITH CANCEL SW ON
- 17-19: CONTINUITY WITH RESUME/ACCEL SW ON
- 5-19: CONTINUITY WITH SET/COAST SW ON

C17 CRUISE CONTROL ECU

- 14-GROUND: APPROX. 12VOLTS WITH IGNITION SW AT ON POSITION
- 1-GROUND: ALWAYS APPROX. 12VOLTS
- 3-GROUND: CONTINUITY WITH PARKING BRAKE LEVER PULLED UP (ONE OF THE CANCEL SW) OR BRAKE LEVEL WARNING SW ON
- 20-GROUND: PULSE EACH 40CM (DRIVER VEHICLE SLOWLY)
- 18-GROUND: APPROX. 418 Ω WITH CANCEL SW ON IN CONTROL SW (USA)
- APPROX. 68 Ω WITH RES/ACC SW ON IN CONTROL SW (USA)
- APPROX. 198 Ω WITH SET/COAST SW ON IN CONTROL SW (USA)
- 17-GROUND: CONTINUITY WITH CANCEL SW ON IN CONTROL SW (CANADA)
- 18-GROUND: CONTINUITY WITH RES/ACCEL SW ON IN CONTROL SW (CANADA)
- 19-GROUND: CONTINUITY WITH SET/COAST SW ON IN CONTROL SW (CANADA)
- 13-GROUND: ALWAYS CONTINUITY
- 2-GROUND: CONTINUITY WITH CLUTCH PEDAL DEPRESSED (M/T)
- CONTINUITY WITH SHIFT LEVER AT "P" OR "N" RANGE (A/T)
- 4-GROUND: CONTINUITY WITH CRUISE CONTROL MAIN SW ON

○ : PARTS LOCATION

CODE	SEE PAGE	CODE	SEE PAGE	CODE	SEE PAGE
C 1	20(5S-FE), 21(3S-GTE)	C17	22	J 1	22
C 5	20(5S-FE), 21(3S-GTE)	E 6	D 20(5S-FE)	J 3	22
C10	B 22	E 7	A 21(3S-GTE)	P 1	22
C11	A 22		C 20(5S-FE)	S 1	20
C14	22	E 8	B 20(5S-FE)	S 9	22
C16	22(3S-GTE M/T)		E 20(5S-FE)		

○ : RELAY BLOCKS

CODE	SEE PAGE	RELAY BLOCKS (RELAY BLOCK LOCATION)
1	18	R/B NO.1 (LEFT KICK PANEL)
2	18	R/B NO.2 (ENGINE COMPARTMENT LEFT)

○ : JUNCTION BLOCK AND WIRE HARNESS CONNECTOR

CODE	SEE PAGE	JUNCTION BLOCK AND WIRE HARNESS (CONNECTOR LOCATION)
3A	19	COWL WIRE AND J/B NO.3 (BEHIND COMBINATION METER)
3B		
3D		



CRUISE CONTROL

☐ : CONNECTOR JOINING WIRE HARNESS AND WIRE HARNESS

CODE	SEE PAGE	JOINING WIRE HARNESS AND WIRE HARNESS (CONNECTOR LOCATION)
EA1	24(5S-FE)	ENGINE WIRE AND ENGINE ROOM MAIN WIRE (REAR LUGGAGE COMPARTMENT LEFT)
	26(3S-GTE)	
EA2	24(5S-FE)	
EA3	24(5S-FE)	ENGINE WIRE AND ENGINE ROOM MAIN WIRE (R/B NO.2 INNER)
	26(3S-GTE)	
EB1	24(5S-FE)	ENGINE WIRE AND R/B NO.2 (R/B NO.2 INNER)
	26(3S-GTE)	
IE1	28	ENGINE ROOM MAIN WIRE AND COWL WIRE (LEFT KICK PANEL)
IE3		
IE4		
II2	30	LUGGAGE ROOM WIRE AND COWL WIRE (RIGHT KICK PANEL)
IK1	30	FLOOR WIRE AND COWL WIRE (RIGHT KICK PANEL)
BM2	32	COWL WIRE AND ENGINE ROOM MAIN WIRE (ROOM PARTITION BOARD LEFT)

▽ : GROUND POINTS

CODE	SEE PAGE	GROUND POINTS LOCATION
EA	24(5S-FE)	INTAKE MANIFOLD
	26(3S-GTE)	
IC	28	INSTRUMENT PANEL BRACE LH
ID	28	RIGHT KICK PANEL

○ : SPLICE POINTS

CODE	SEE PAGE	WIRE HARNESS WITH SPLICE POINTS	CODE	SEE PAGE	WIRE HARNESS WITH SPLICE POINTS
E 1	24(5S-FE)	ENGINE ROOM MAIN WIRE	I 9	30	COWL WIRE
	26(3S-GTE)		I10		
E14	24(5S-FE)	ENGINE WIRE			

C 1 DARK GRAY

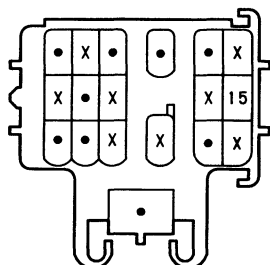

C 5 GRAY

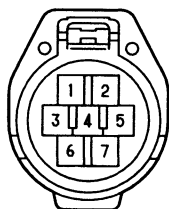

C10 (B) BLUE

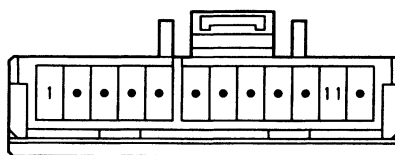

C11 (A)

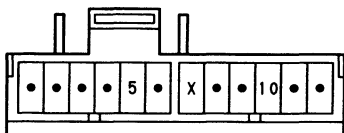

(USA) C14 BLACK

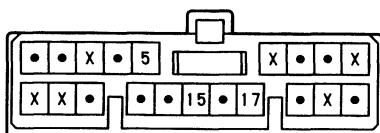

(CANADA) C14 BLACK

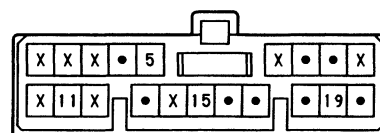

C16 WHITE



C17

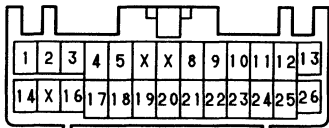

E 6 (D) DARK GRAY

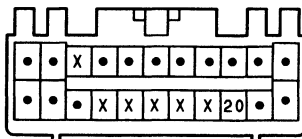

E 7 (A) DARK GRAY

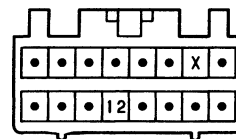

E 7 (C) DARK GRAY

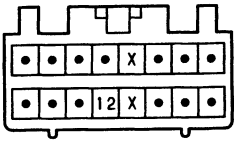

E 8 (B) DARK GRAY

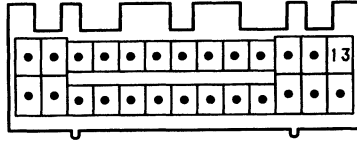

E 8 (E) DARK GRAY

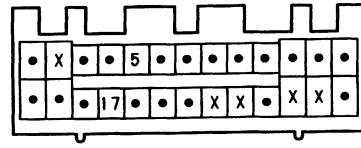

J 1

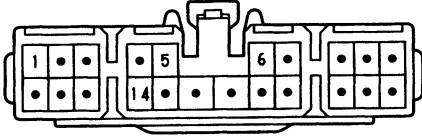

J 3

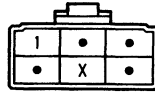

P 1 BLACK



S 1 GRAY



S 9





CIGARETTE LIGHTER AND CLOCK

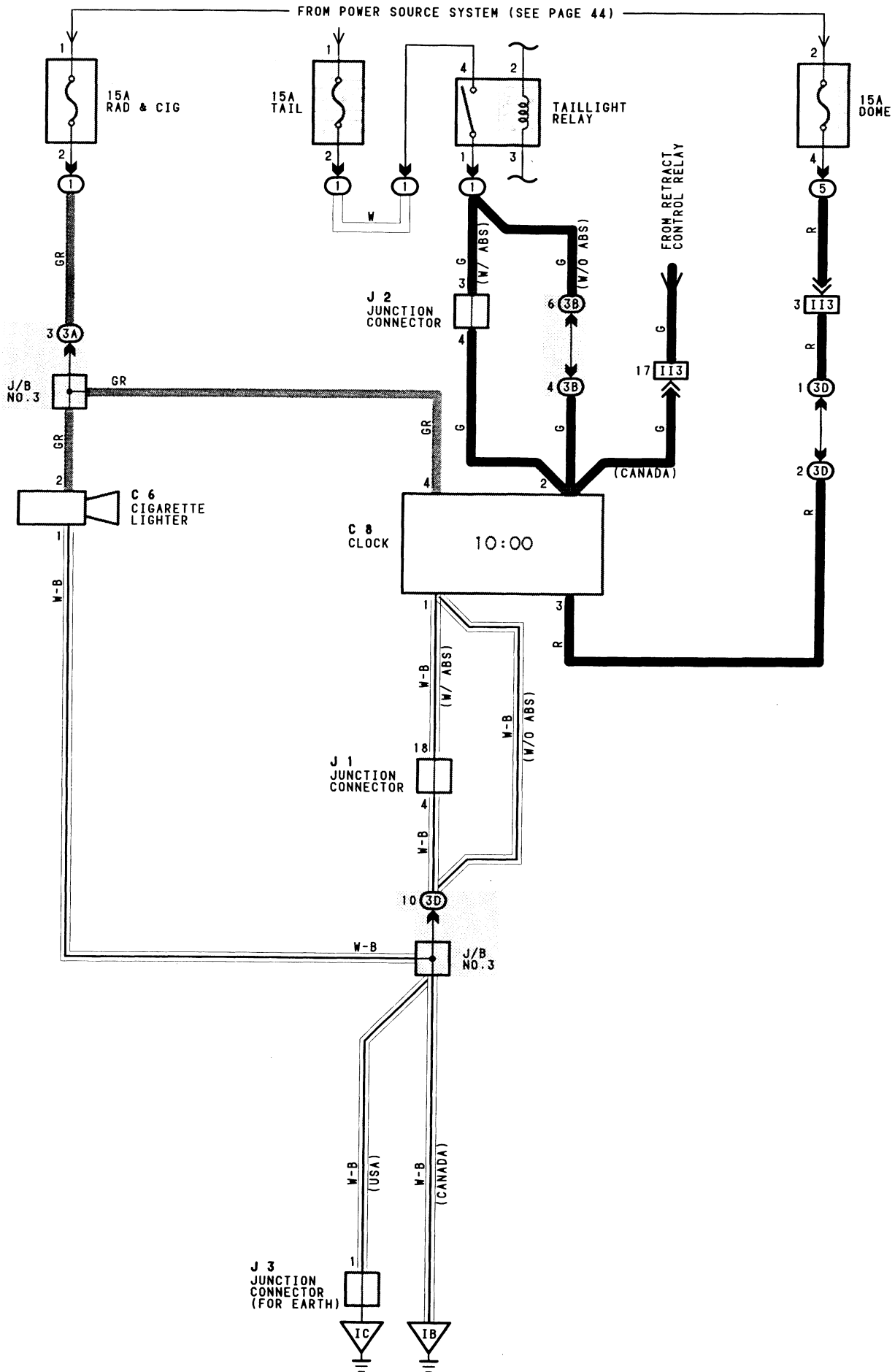

SERVICE HINTS

C 6 CIGARETTE LIGHTER

2-GROUND: APPROX. 12VOLTS WITH IGNITION SW AT ACC OR ON POSITION
 1-GROUND: ALWAYS CONTINUITY

C 8 CLOCK

3-GROUND: ALWAYS APPROX. 12VOLTS (POWER FOR CLOCK)
 4-GROUND: APPROX. 12VOLTS WITH IGNITION SW AT ACC OR ON POSITION (POWER FOR INDICATION)
 2-GROUND: APPROX. 12VOLTS WITH LIGHT CONTROL SW AT TAIL OR HEAD POSITION
 APPROX. 12VOLTS WITH ENGINE RUNNING (CANADA)
 1-GROUND: ALWAYS CONTINUITY

○ : PARTS LOCATION

CODE	SEE PAGE	CODE	SEE PAGE	CODE	SEE PAGE
C 6	22	J 1	22	J 3	22
C 8	22	J 2	22		

○ : RELAY BLOCKS

CODE	SEE PAGE	RELAY BLOCKS (RELAY BLOCK LOCATION)
1	18	R/B NO.1 (LEFT KICK PANNEL)
5	17	R/B NO.5 (FRONT LUGGAGE COMPARTMENT RIGHT)

○ : JUNCTION BLOCK AND WIRE HARNESS CONNECTOR

CODE	SEE PAGE	JUNCTION BLOCK AND WIRE HARNESS (CONNECTOR LOCATION)
3A	19	COWL WIRE AND J/B NO.3 (BEHIND COMBINATION METER)
3B		
3D		

□ : CONNECTOR JOINING WIRE HARNESS AND WIRE HARNESS

CODE	SEE PAGE	JOINING WIRE HARNESS AND WIRE HARNESS (CONNECTOR LOCATION)
I13	30	LUGGAGE ROOM WIRE AND COWL WIRE (RIGHT KICK PANEL)

▽ : GROUND POINTS

CODE	SEE PAGE	GROUND POINTS LOCATION
IB	28	LEFT KICK PANEL
IC	28	INSTRUMENT PANEL BRACE LH

C 6



C 8

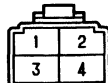

J 1

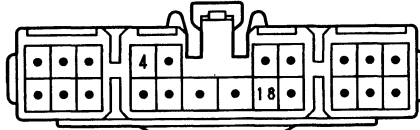

J 2



J 3

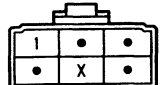



AUTO ANTENNA

FROM POWER SOURCE SYSTEM (SEE PAGE 44)

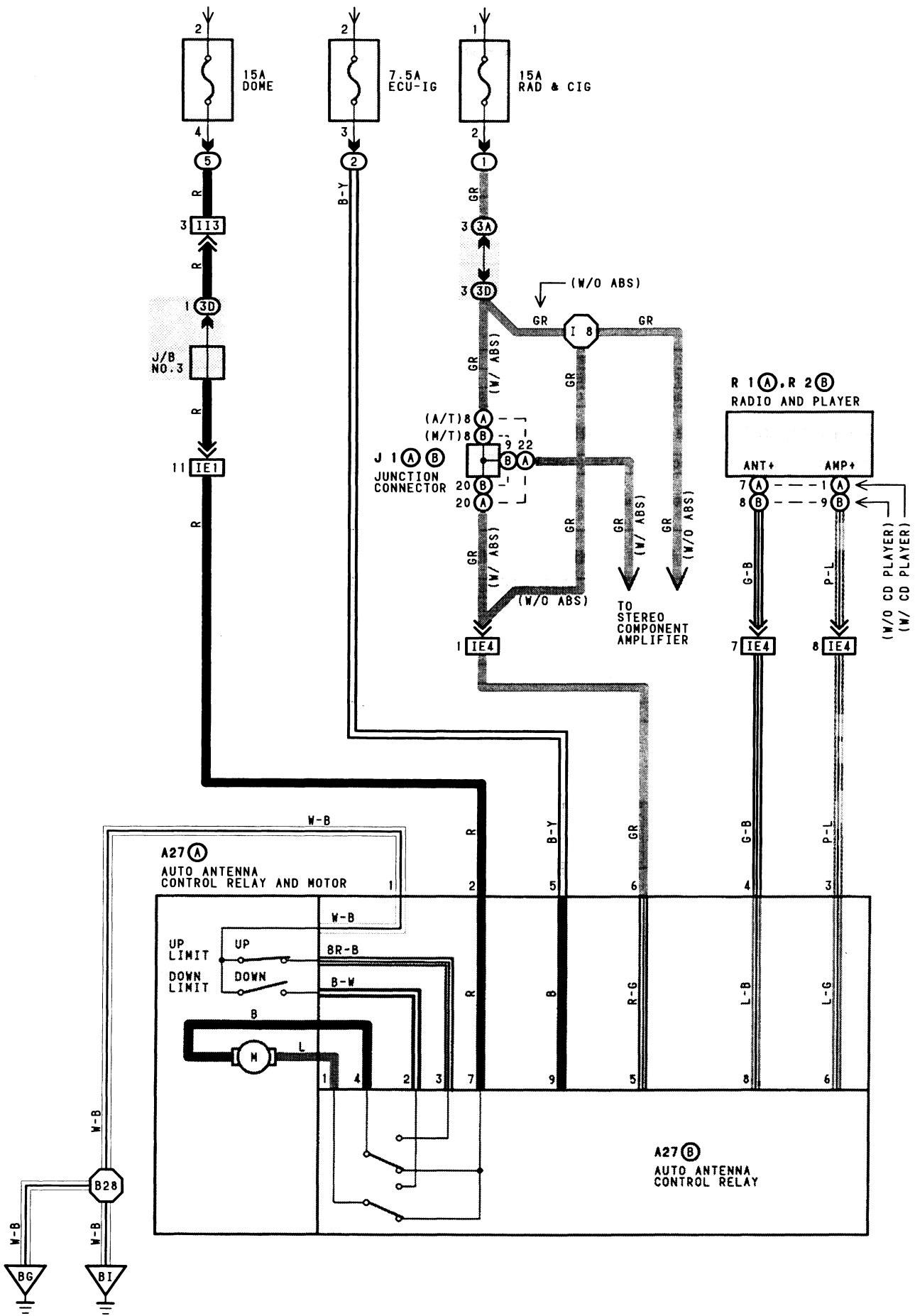

SERVICE HINTS

A27 Ⓑ AUTO ANTENNA CONTROL RELAY

- 9-GROUND: APPROX. 12VOLTS WITH IGNITION SW AT ON POSITION
- 5-GROUND: APPROX. 12VOLTS WITH IGNITION SW AT ACC OR ON POSITION
- 7-GROUND: ALWAYS APPROX. 12VOLTS
- 8-GROUND: APPROX. 12VOLTS WITH IGNITION SW AT ACC OR ON POSITION AND RADIO SW ON
- 3-GROUND: CONTINUITY (UPPER LIMIT SW ON) UNLESS ANTENNA AT UP STOP
- 2-GROUND: CONTINUITY (DOWN LIMIT SW ON) UNLESS ANTENNA AT DOWN STOP
- 4-3: CLOSED WITH IGNITION SW AT ACC OR ON POSITION AND RADIO SW ON AND PLAYER SW OFF UNTIL ANTENNA AT UPPERMOST POSITION
- 1-2: CLOSED WITH IGNITION SW AT ACC OR ON POSITION AND RADIO SW OFF AND PLAYER SW OFF UNTIL ANTENNA AT LOWERMOST POSITION
- 1-2: CLOSED WITH IGNITION SW OFF UNTIL ANTENNA AT LOWERMOST POSITION

○ : PARTS LOCATION

CODE	SEE PAGE	CODE	SEE PAGE	CODE	SEE PAGE
A27	A 23	J 1	A 22	R 1	A 22
	B 23		B 22	R 2	B 22

○ : RELAY BLOCKS

CODE	SEE PAGE	RELAY BLOCKS (RELAY BLOCK LOCATION)
1	18	R/B NO.1 (LEFT KICK PANEL)
2	18	R/B NO.2 (ENGINE COMPARTMENT LEFT)
5	17	R/B NO.5 (FRONT LUGGAGE COMPARTMENT RIGHT)

○ : JUNCTION BLOCK AND WIRE HARNESS CONNECTOR

CODE	SEE PAGE	JUNCTION BLOCK AND WIRE HARNESS (CONNECTOR LOCATION)
3A	19	COWL WIRE AND J/B NO.3 (BEHIND COMBINATION METER)
3D		

□ : CONNECTOR JOINING WIRE HARNESS AND WIRE HARNESS

CODE	SEE PAGE	JOINING WIRE HARNESS AND WIRE HARNESS (CONNECTOR LOCATION)
IE1	28	ENGINE ROOM MAIN WIRE AND COWL WIRE (LEFT KICK PANEL)
IE4		
II3	30	COWL WIRE AND LUGGAGE ROOM WIRE (RIGHT KICK PANEL)

▽ : GROUND POINTS

CODE	SEE PAGE	GROUND POINTS LOCATION
BI	32	BACK PANEL CENTER
B6	32	UNDER THE LEFT CENTER PILLAR

○ : SPLICE POINTS

CODE	SEE PAGE	WIRE HARNESS WITH SPLICE POINTS	CODE	SEE PAGE	WIRE HARNESS WITH SPLICE POINTS
I 8	30	COWL WIRE	B28	32	ENGINE ROOM MAIN WIRE

A27 Ⓐ



A27 Ⓑ

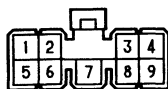

J 1 Ⓐ

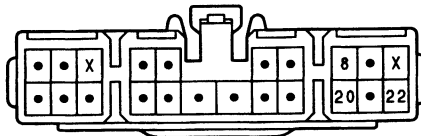

J 1 Ⓑ

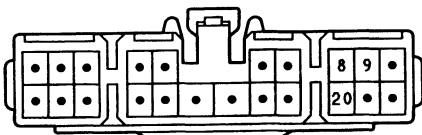

R 1 Ⓐ WHITE

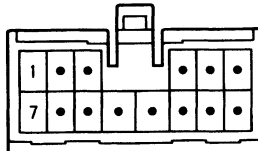

R 2 Ⓑ WHITE

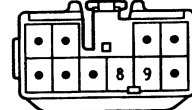



RADIO AND PLAYER (w/ CD PLAYER)

FROM POWER SOURCE SYSTEM (SEE PAGE 44)

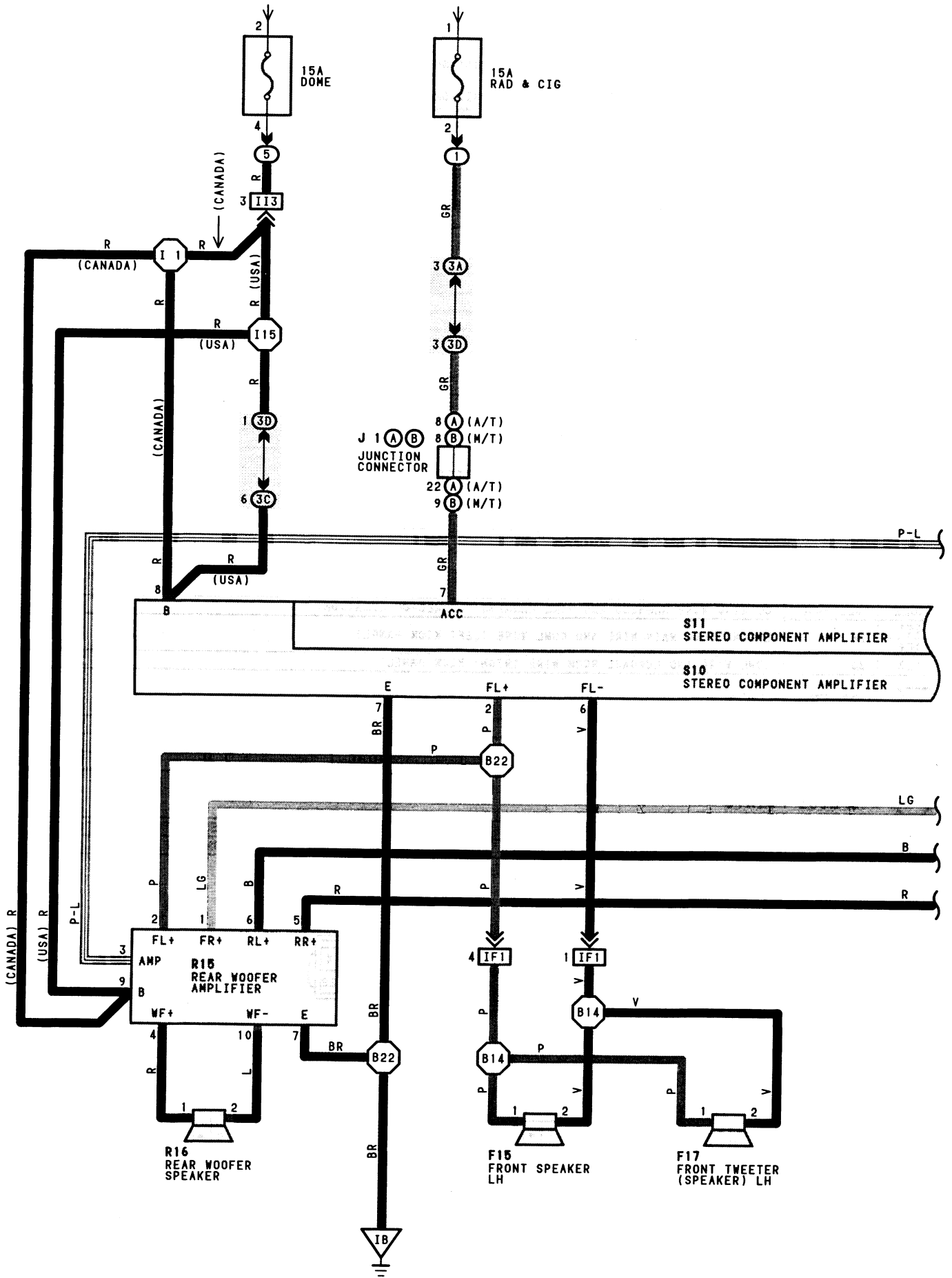

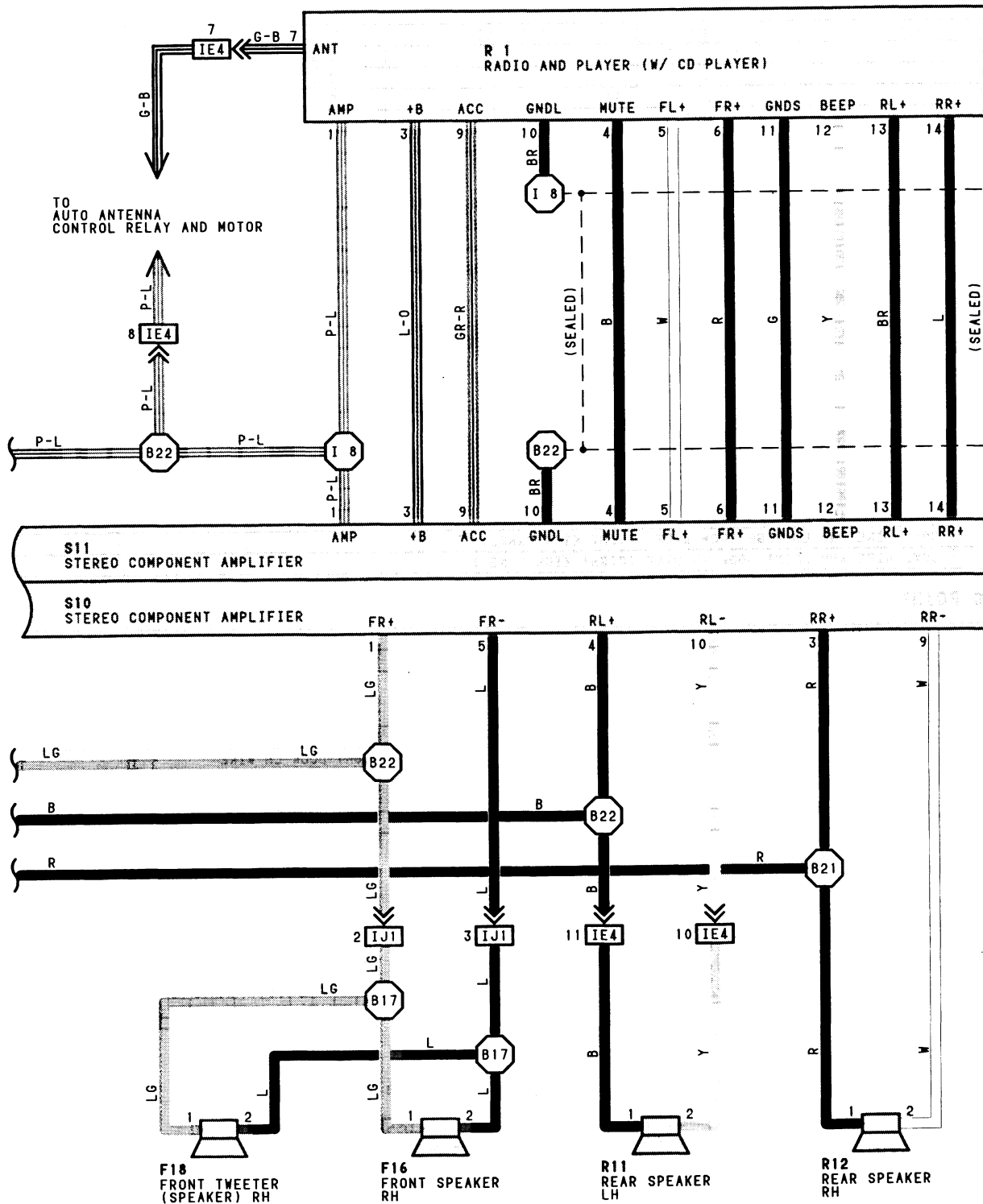



RADIO AND PLAYER (w/ CD PLAYER)

SERVICE HINTS

S10 STEREO COMPONENT AMPLIFIER

8-GROUND: ALWAYS APPROX. 12VOLTS

7-GROUND: ALWAYS CONTINUITY

S11 STEREO COMPONENT AMPLIFIER

7-GROUND: APPROX. 12VOLTS WITH IGNITION SW AT ON OR ACC POSITION

○ : PARTS LOCATION

CODE	SEE PAGE	CODE	SEE PAGE	CODE	SEE PAGE
F15	23	J 1 B	22	R16	23
F16	23	R 1	22	S10	23
F17	23	R11	23	S11	23
F18	23	R12	23		
J 1 A	22	R15	23		

○ : RELAY BLOCKS

CODE	SEE PAGE	RELAY BLOCKS (RELAY BLOCK LOCATION)
1	18	R/B NO.1 (LEFT KICK PANEL)
5	17	R/B NO.5 (FRONT LUGGAGE COMPARTMENT RIGHT)

○ : JUNCTION BLOCK AND WIRE HARNESS CONNECTOR

CODE	SEE PAGE	JUNCTION BLOCK AND WIRE HARNESS (CONNECTOR LOCATION)
3A	19	COWL WIRE AND J/B NO.3 (BEHIND COMBINATION METER)
3C		
3D		

□ : CONNECTOR JOINING WIRE HARNESS AND WIRE HARNESS

CODE	SEE PAGE	JOINING WIRE HARNESS AND WIRE HARNESS (CONNECTOR LOCATION)
IE4	28	ENGINE ROOM MAIN WIRE AND COWL WIRE (LEFT KICK PANEL)
IF1	28	COWL WIRE AND FRONT DOOR LH WIRE (LEFT KICK PANEL)
II3	30	COWL WIRE AND LUGGAGE ROOM WIRE (RIGHT KICK PANEL)
IJ1	30	COWL WIRE AND FRONT DOOR RH WIRE (RIGHT KICK PANEL)

▽ : GROUND POINTS

CODE	SEE PAGE	GROUND POINTS LOCATION
IB	28	LEFT KICK PANEL

○ : SPLICE POINTS

CODE	SEE PAGE	WIRE HARNESS WITH SPLICE POINTS	CODE	SEE PAGE	WIRE HARNESS WITH SPLICE POINTS
I 1	30	COWL WIRE	B17	32	FRONT DOOR LH WIRE
I 8			32	B21	COWL WIRE
I15				B22	
B14	32	FRONT DOOR RH WIRE			

F15, F16 GRAY



F17, F18



J 1 (A) (B)

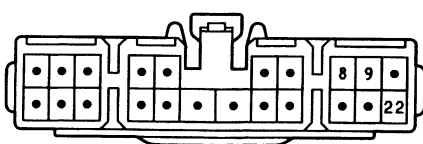

R 1 WHITE

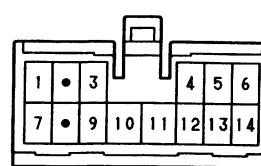

R11, R12, R16

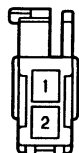

R15 WHITE

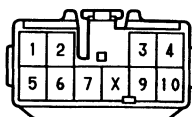

S10

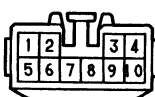

S11

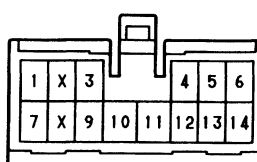



RADIO AND PLAYER (w/o CD PLAYER)

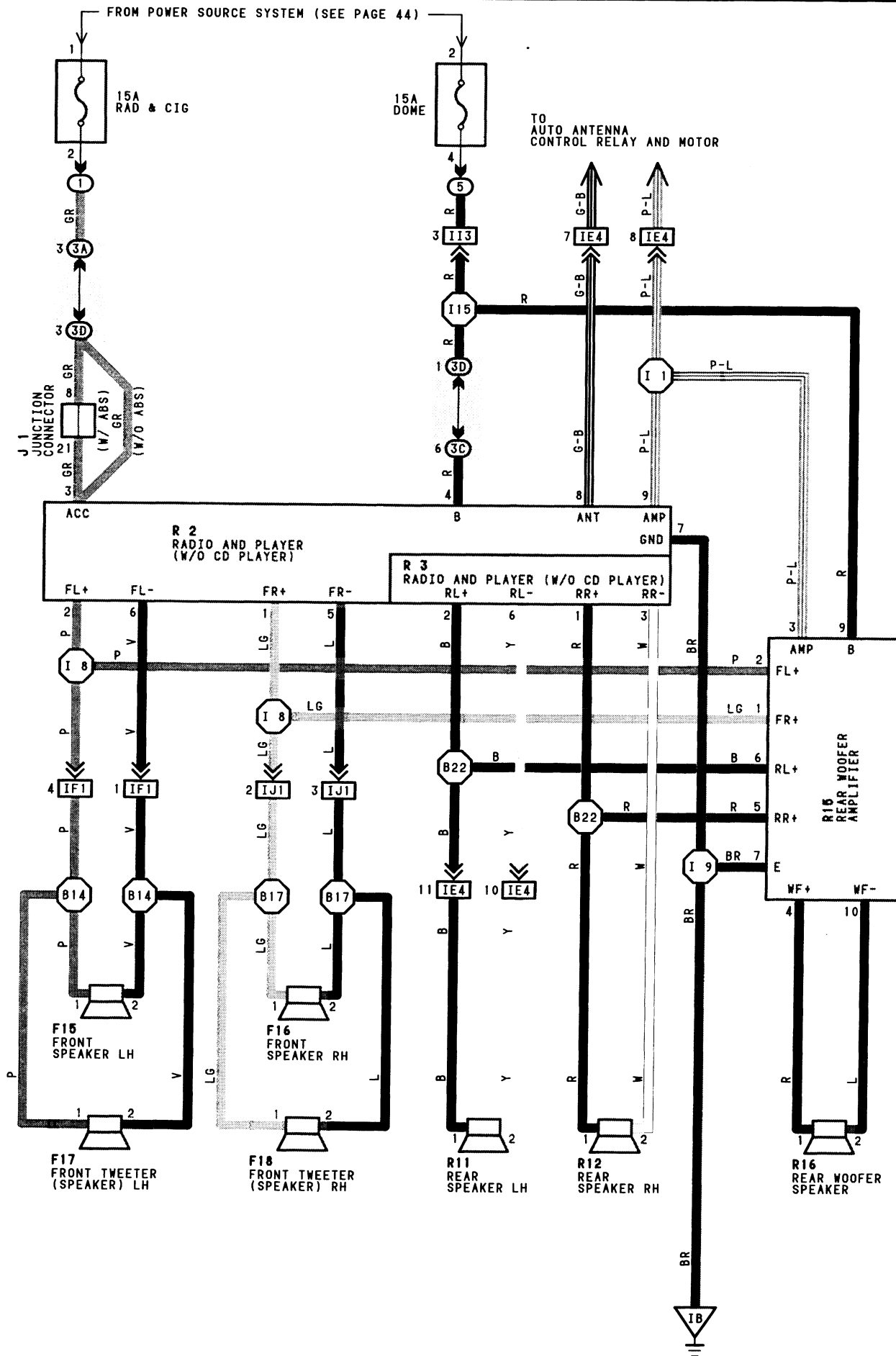

SERVICE HINTS

R 2 RADIO AND PLAYER

- 4-GROUND: ALWAYS APPROX. 12VOLTS
- 3-GROUND: APPROX. 12VOLTS WITH IGNITION SW AT ON OR ACC POSITION
- 7-GROUND: ALWAYS CONTINUITY

○ : PARTS LOCATION

CODE	SEE PAGE	CODE	SEE PAGE	CODE	SEE PAGE
F15	23	J 1	22	R12	23
F16	23	R 2	22	R15	23
F17	23	R 3	22	R16	23
F18	23	R11	23		

○ : RELAY BLOCKS

CODE	SEE PAGE	RELAY BLOCKS (RELAY BLOCK LOCATION)
1	18	R/B NO.1 (LEFT KICK PANEL)
5	17	R/B NO.5 (FRONT LUGGAGE COMPARTMENT RIGHT)

○ : JUNCTION BLOCK AND WIRE HARNESS CONNECTOR

CODE	SEE PAGE	JUNCTION BLOCK AND WIRE HARNESS (CONNECTOR LOCATION)
3A	19	COWL WIRE AND J/B NO.3 (BEHIND COMBINATION METER)
3C		
3D		

□ : CONNECTOR JOINING WIRE HARNESS AND WIRE HARNESS

CODE	SEE PAGE	JOINING WIRE HARNESS AND WIRE HARNESS (CONNECTOR LOCATION)
IE4	28	ENGINE ROOM MAIN WIRE AND COWL WIRE (LEFT KICK PANEL)
IF1	28	COWL WIRE AND FRONT DOOR LH WIRE (LEFT KICK PANEL)
II3	30	COWL WIRE AND LUGGAGE ROOM WIRE (RIGHT KICK PANEL)
IJ1	30	COWL WIRE AND FRONT DOOR RH WIRE (RIGHT KICK PANEL)

▽ : GROUND POINTS

CODE	SEE PAGE	GROUND POINTS LOCATION
IB	28	LEFT KICK PANEL

○ : SPLICE POINTS

CODE	SEE PAGE	WIRE HARNESS WITH SPLICE POINTS	CODE	SEE PAGE	WIRE HARNESS WITH SPLICE POINTS
I 1	30	COWL WIRE	B14	32	FRONT DOOR RH WIRE
I 8			B17	32	FRONT DOOR LH WIRE
I 9			B22	32	COWL WIRE
I15					

F15, F16 GRAY

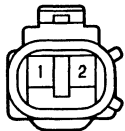

F17, F18



J 1

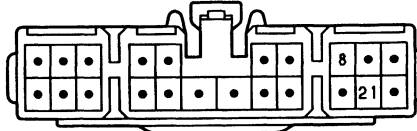

R 2 WHITE

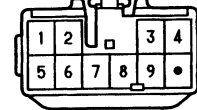

R 3 WHITE

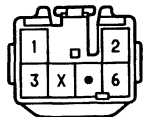

R11, R12



R15 WHITE

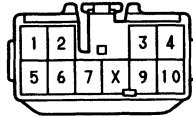

R16

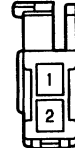



COMBINATION METER

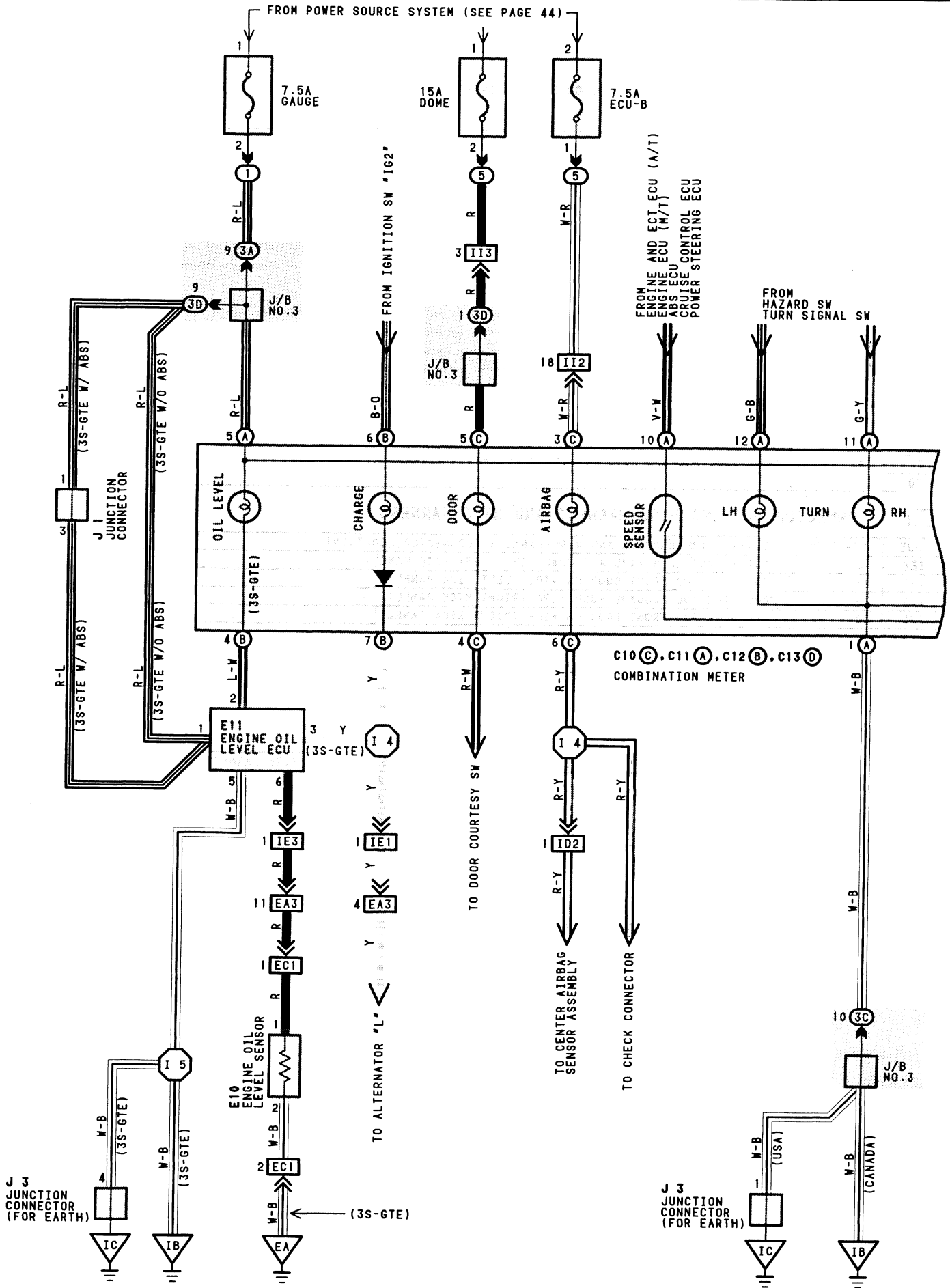

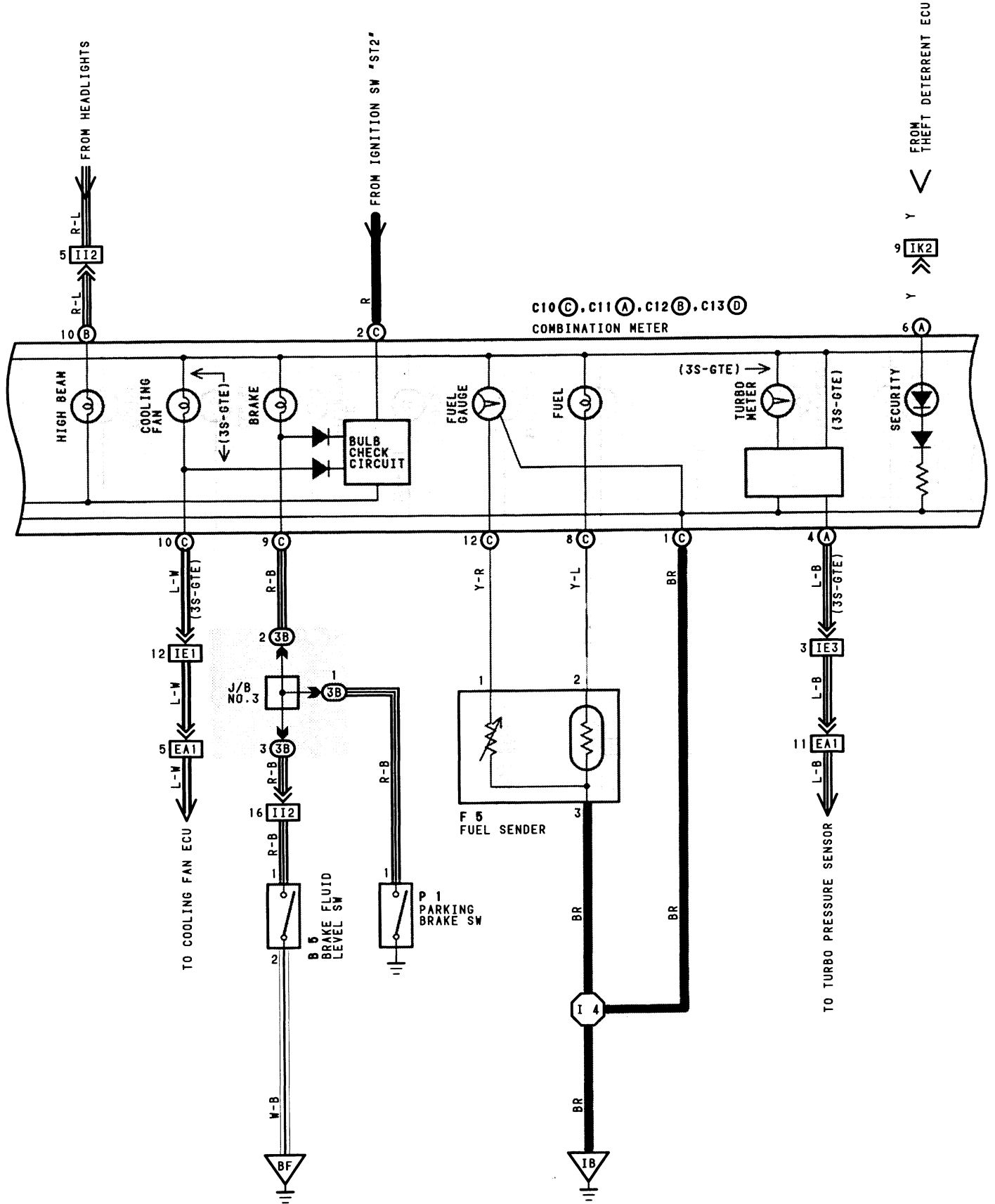



COMBINATION METER

C10 (C), C11 (A), C12 (B), C13 (D)
COMBINATION METER

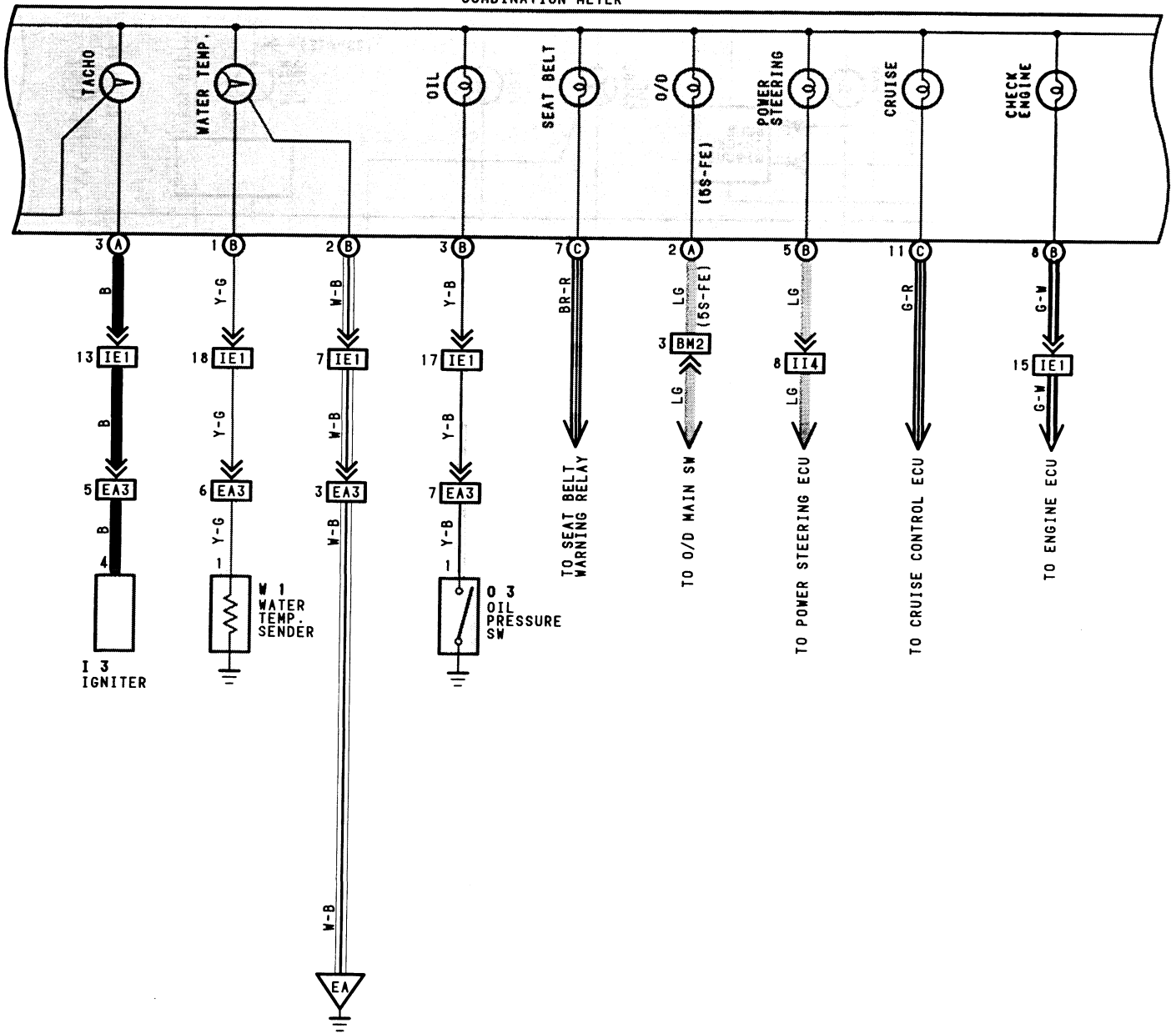

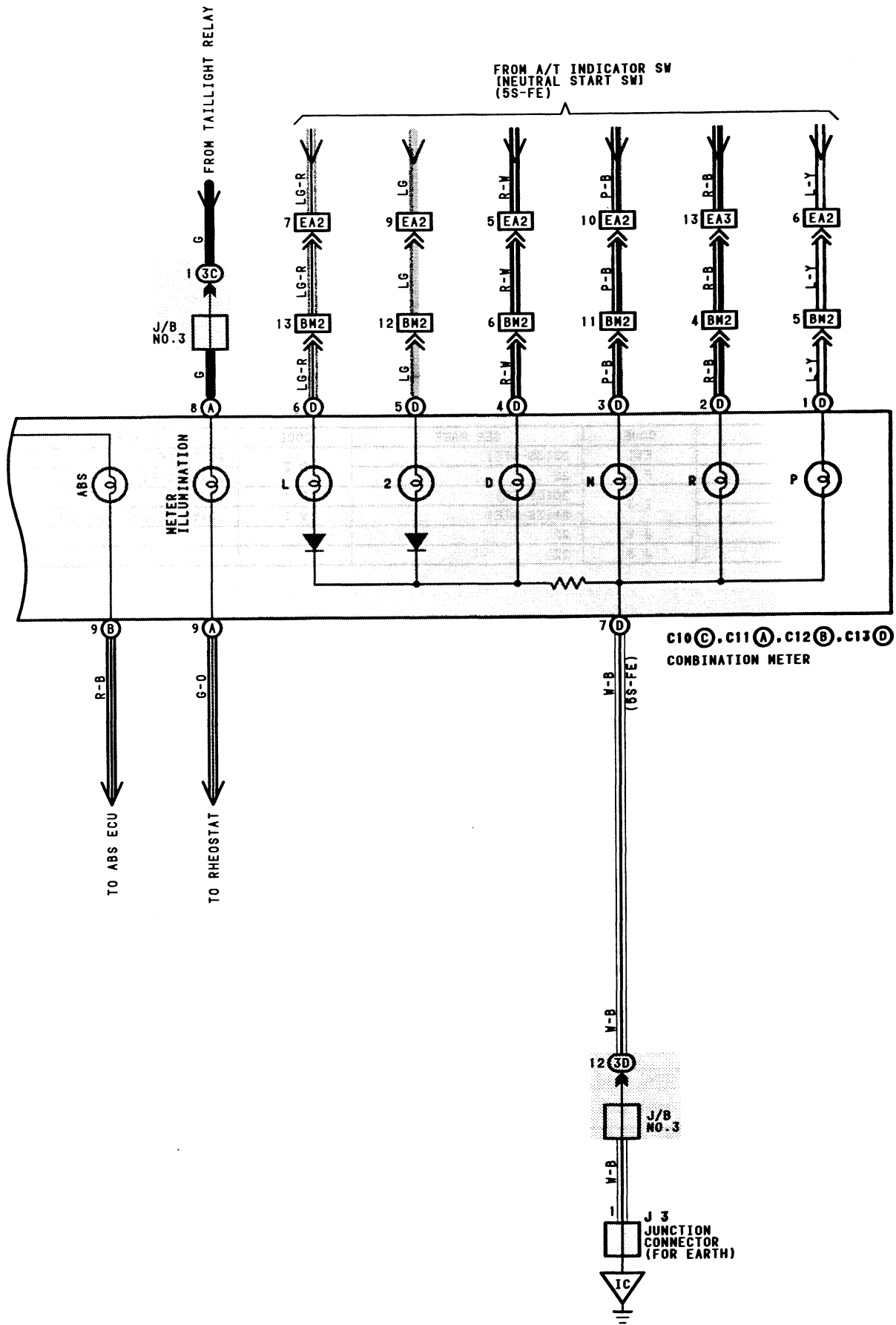



COMBINATION METER

SERVICE HINTS

B 5 BRAKE FLUID LEVEL SW

1-2:CLOSED WITH FLOAT DOWN

C10 (C), C11 (A), C12 (B) COMBINATION METER

(C) 3, (C) 5-GROUND:ALWAYS APPROX. 12VOLTS

(A) 5-GROUND:APPROX. 12VOLTS WITH IGNITION SW AT ON POSITION

(A) 1, (B) 3, (C) 1-GROUND:ALWAYS CONTINUITY

C13 (D) COMBINATION METER (5S-FE A/T)

(D) 7-GROUND:ALWAYS CONTINUITY

E11 ENGINE OIL LEVEL ECU (3S-GTE)

1-GROUND:APPROX. 12VOLTS WITH IGNITION SW AT ON POSITION

5-GROUND:ALWAYS CONTINUITY

O 3 OIL PRESSURE SW

1-GROUND:CLOSED WITH OIL PRESSURE BELOW 0.2KG/CM² (2.84PSI, 19.61KPA)

P 1 PARKING BRAKE SW

1-GROUND:CLOSED WITH PARKING BRAKE LEVER PULLED UP

W 1 WATER TEMP. SENSOR

1-GROUND:APPROX. 198.5Ω AT 50°C (122°F)

APPROX. 29.7Ω AT 105°C (221°F)

○ : PARTS LOCATION

CODE	SEE PAGE	CODE	SEE PAGE	CODE	SEE PAGE
B 5	23	E11	23(3S-GTE)	O 3	20(5S-FE)
C10	C 22	F 5	22	P 1	21(3S-GTE)
C11	A 22	I 3	20(5S-FE)	W 1	22
C12	B 22	J 1	21(3S-GTE)		20(5S-FE), 21(3S-GTE)
C13	D 22(5S-FE)	J 3	22		
E10	21(3S-GTE)				

○ : RELAY BLOCKS

CODE	SEE PAGE	RELAY BLOCKS (RELAY BLOCK LOCATION)
1	18	R/B NO.1 (LEFT KICK PANEL)
5	17	R/B NO.5 (FRONT LUGGAGE COMPARTMENT RIGHT)

○ : JUNCTION BLOCK AND WIRE HARNESS CONNECTOR

CODE	SEE PAGE	JUNCTION BLOCK AND WIRE HARNESS (CONNECTOR LOCATION)
3A	19	COWL WIRE AND J/B NO.3 (BEHIND COMBINATION METER)
3B		
3C		
3D		

□ : CONNECTOR JOINING WIRE HARNESS AND WIRE HARNESS

CODE	SEE PAGE	JOINING WIRE HARNESS AND WIRE HARNESS (CONNECTOR LOCATION)
EA1	24(5S-FE)	ENGINE WIRE AND ENGINE ROOM MAIN WIRE (REAR LUGGAGE COMPARTMENT LEFT)
	26(3S-GTE)	
EA2	24(5S-FE)	
EA3	24(5S-FE)	ENGINE WIRE AND ENGINE ROOM MAIN WIRE (R/B NO.2 INNER)
	26(3S-GTE)	
EC1	26(3S-GTE)	ENGINE NO.4 WIRE AND ENGINE WIRE (NEAR THE INTAKE MANIFOLD)
ID2	28	COWL WIRE AND COWL WIRE (BEHIND COMBINATION METER)
IE1	28	ENGINE ROOM MAIN WIRE AND COWL WIRE (LEFT KICK PANEL)
IE3		
II2	30	LUGGAGE ROOM WIRE AND COWL WIRE (RIGHT KICK PANEL)
II3	30	COWL WIRE AND LUGGAGE ROOM WIRE (RIGHT KICK PANEL)
II4		
IK2	30	FLOOR WIRE AND COWL WIRE (RIGHT KICK PANEL)
BM2	32	COWL WIRE AND ENGINE ROOM MAIN WIRE (ROOM PARTITION BOARD LEFT)

▽ : GROUND POINTS

CODE	SEE PAGE	GROUND POINTS LOCATION
EA	24(5S-FE)	INTAKE MANIFOLD
	26(3S-GTE)	
IB	28	LEFT KICK PANEL
IC	28	INSTRUMENT PANEL BRACE LH
BF	32	FRONT LEFT FENDER

○ : SPLICE POINTS

CODE	SEE PAGE	WIRE HARNESS WITH SPLICE POINTS	CODE	SEE PAGE	WIRE HARNESS WITH SPLICE POINTS
I 4	30	COWL WIRE	I 5	30	COWL WIRE

B 5 GRAY

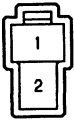

C10 C BLUE

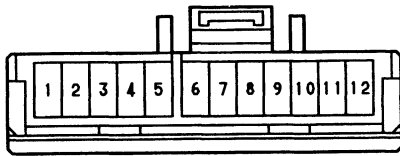

C11 A

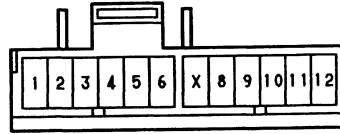

C12 B GRAY

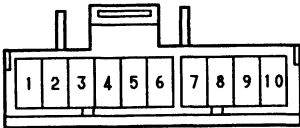

C13 D

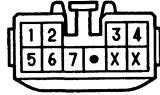

E10 DARK GRAY



E11

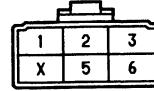

F 5

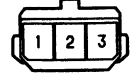

I 3 BLACK



J 1

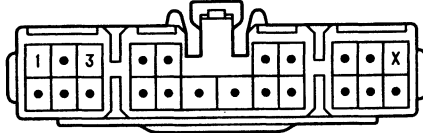

J 3

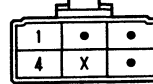

O 3 BLACK



P 1 BLACK



W 1 BLUE





RADIATOR FAN AND AIR CONDITIONER

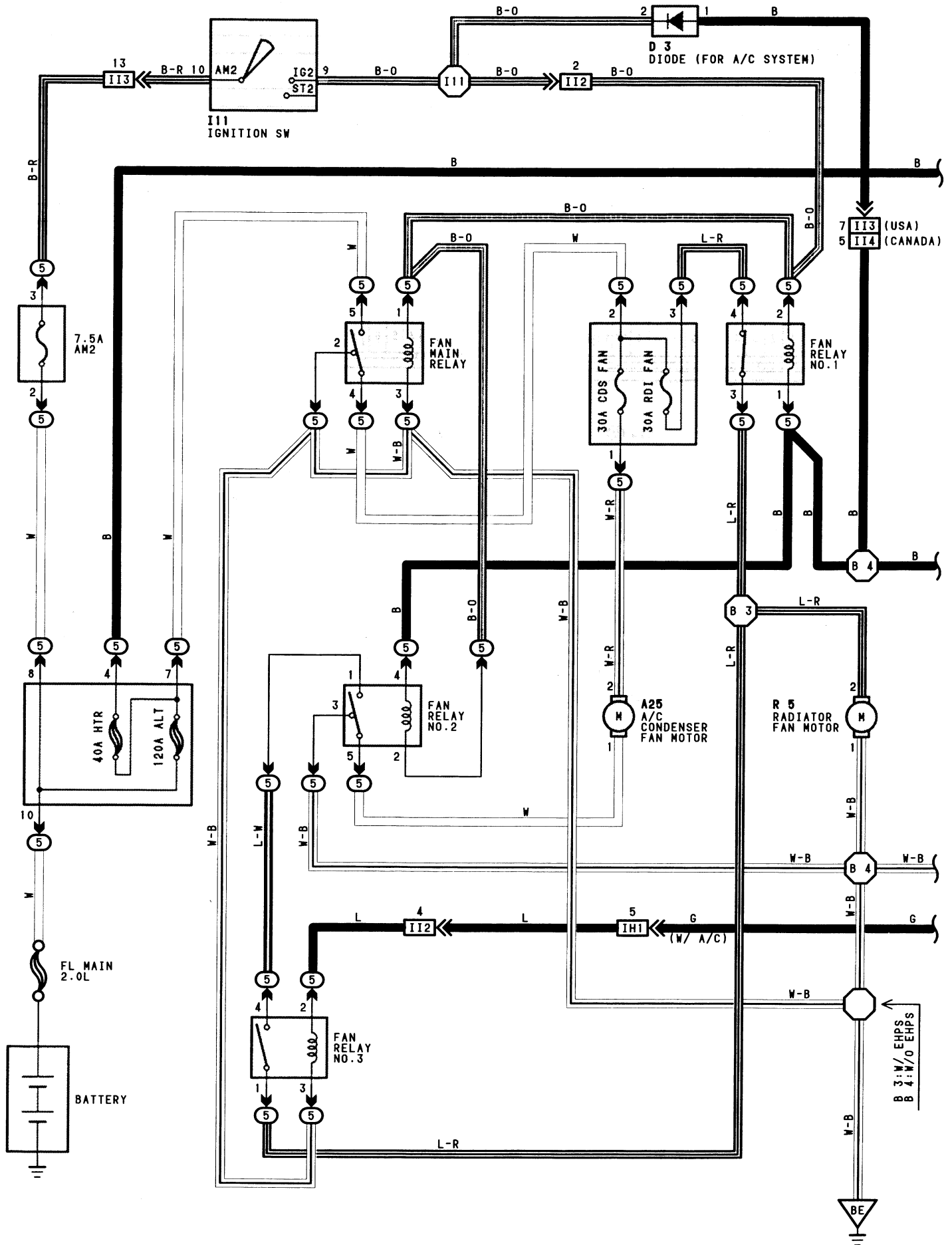

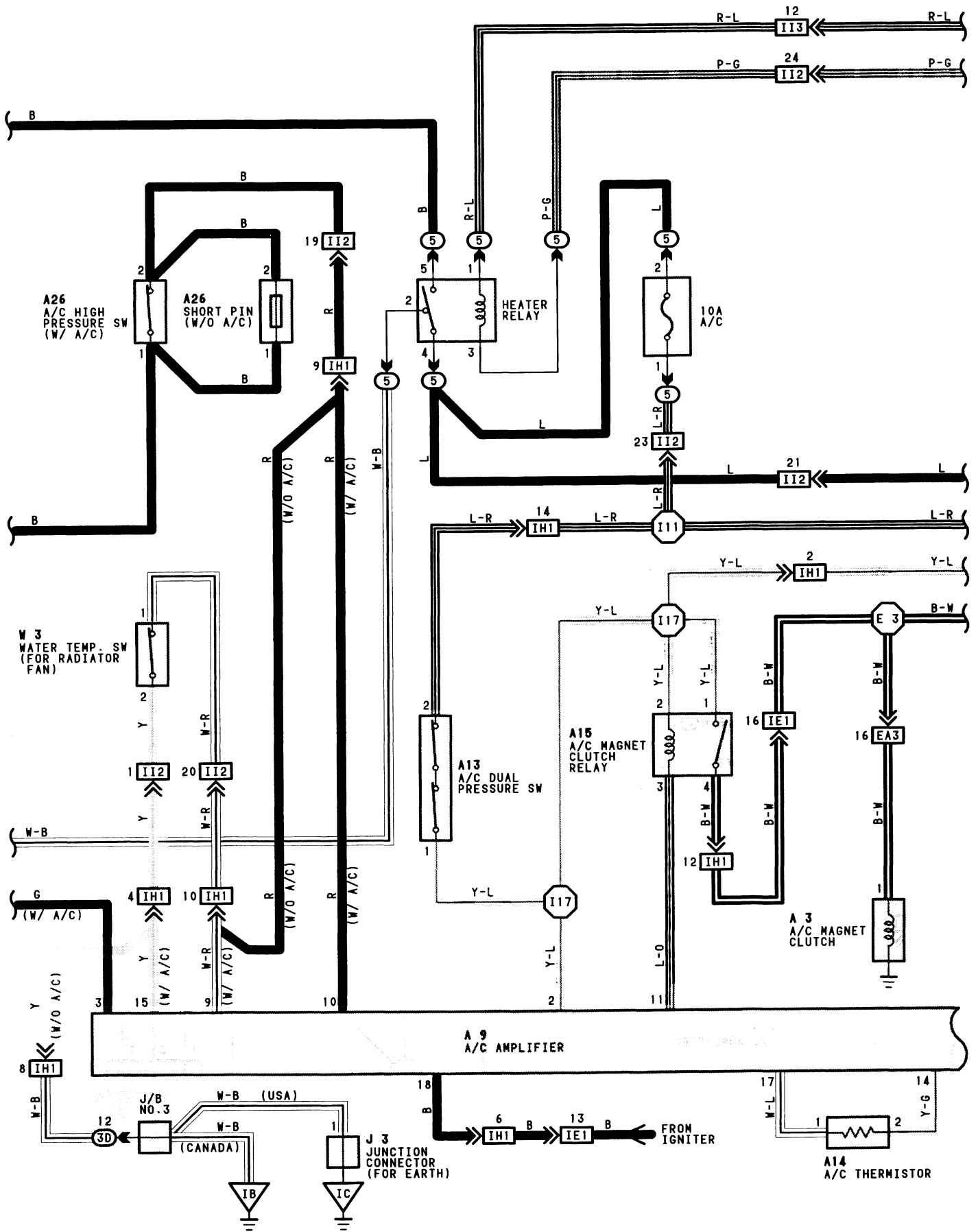



RADIATOR FAN AND AIR CONDITIONER

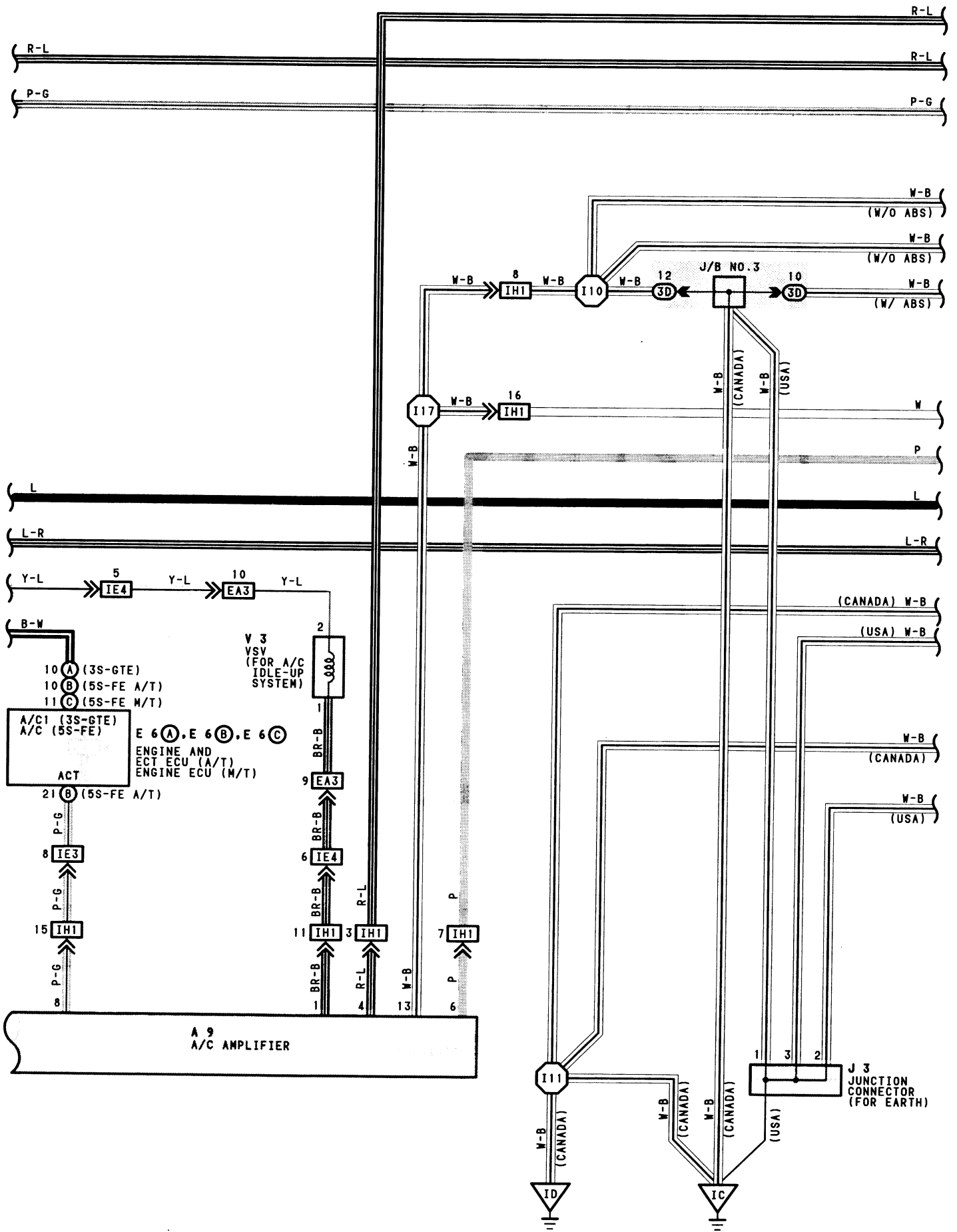

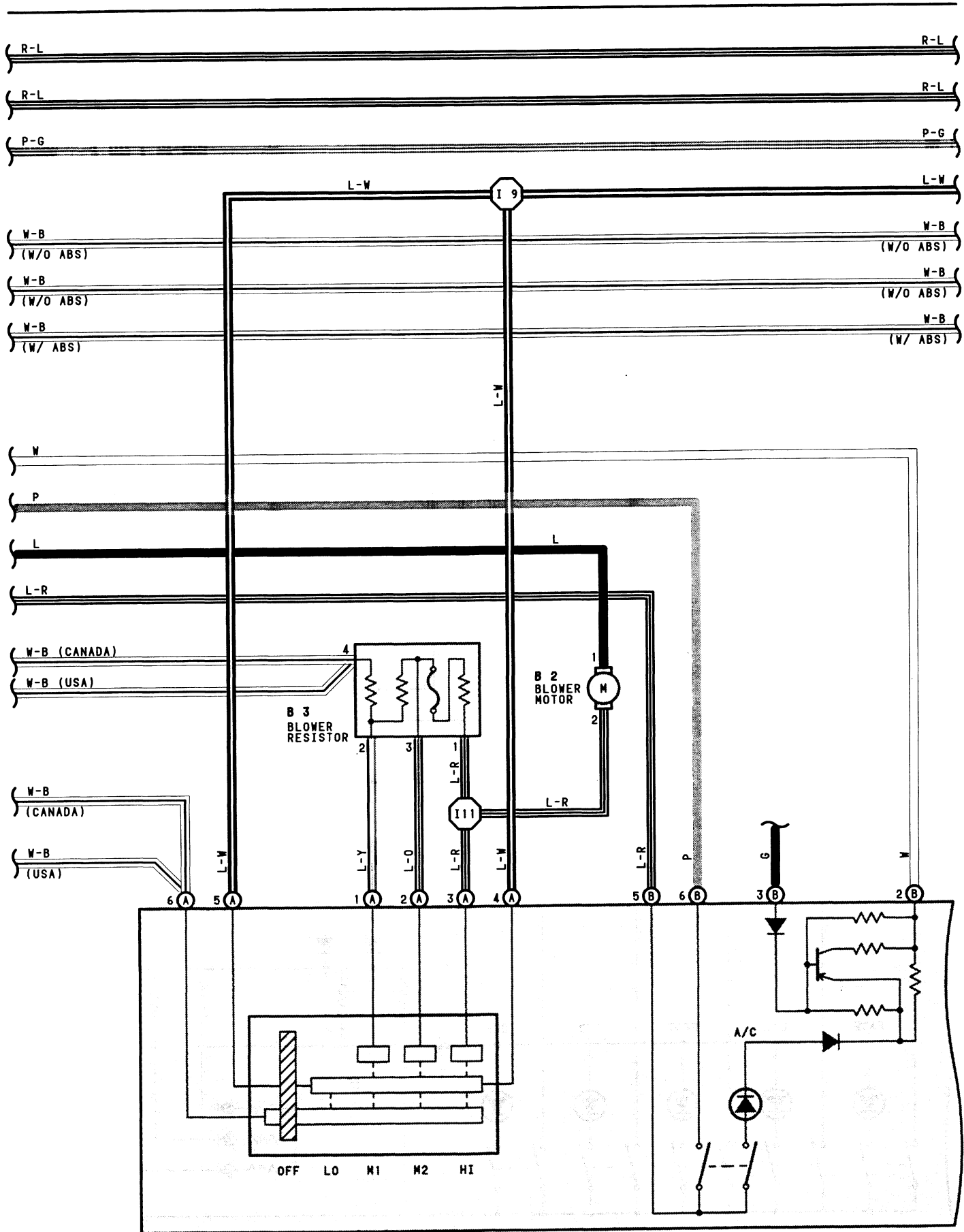

A10 (C), A11 (A), A12 (B)
A/C CONTROL ASSEMBLY



RADIATOR FAN AND AIR CONDITIONER

FROM POWER SOURCE SYSTEM (SEE PAGE 44)

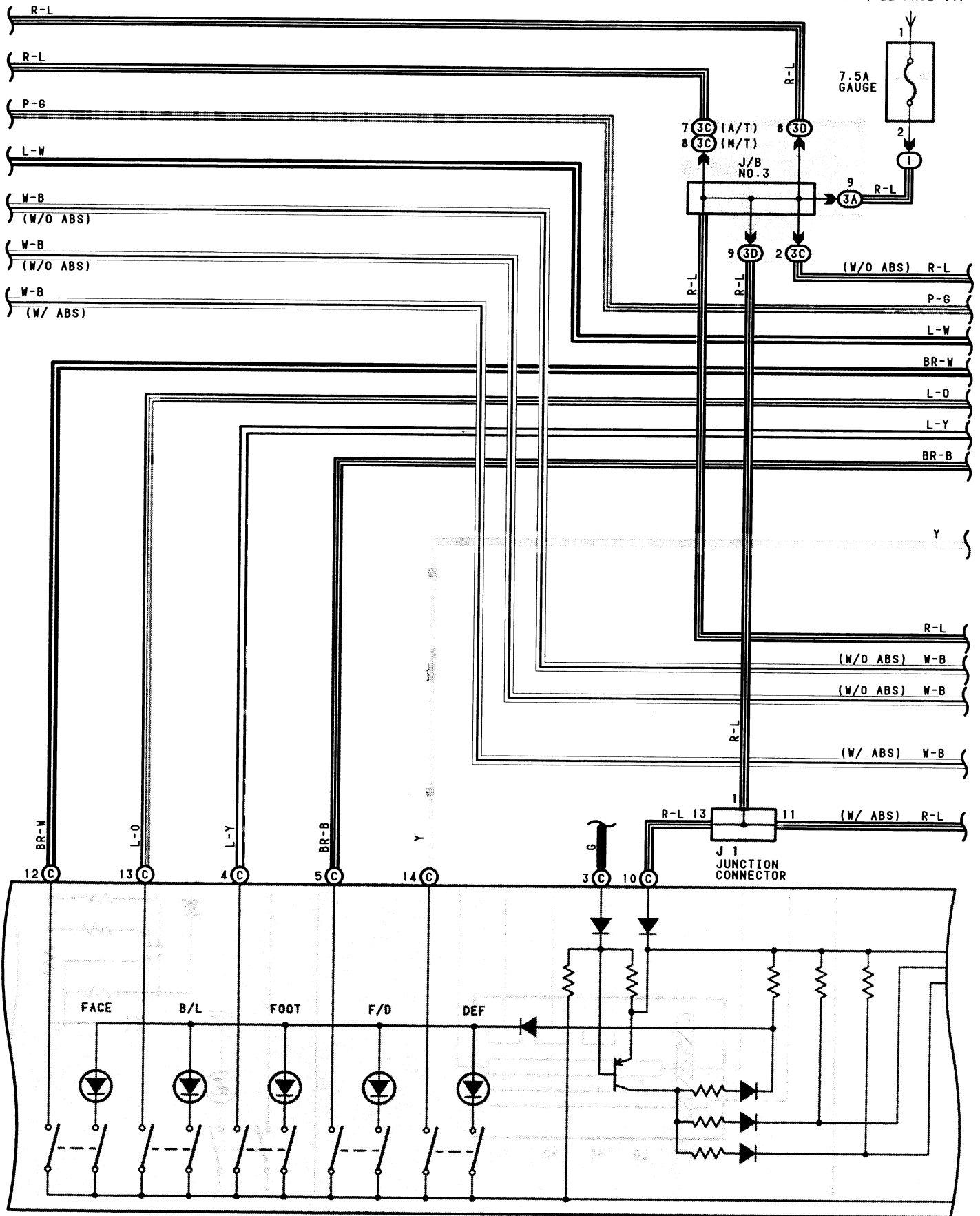

A10 (C), A11 (A), A12 (B)
A/C CONTROL ASSEMBLY

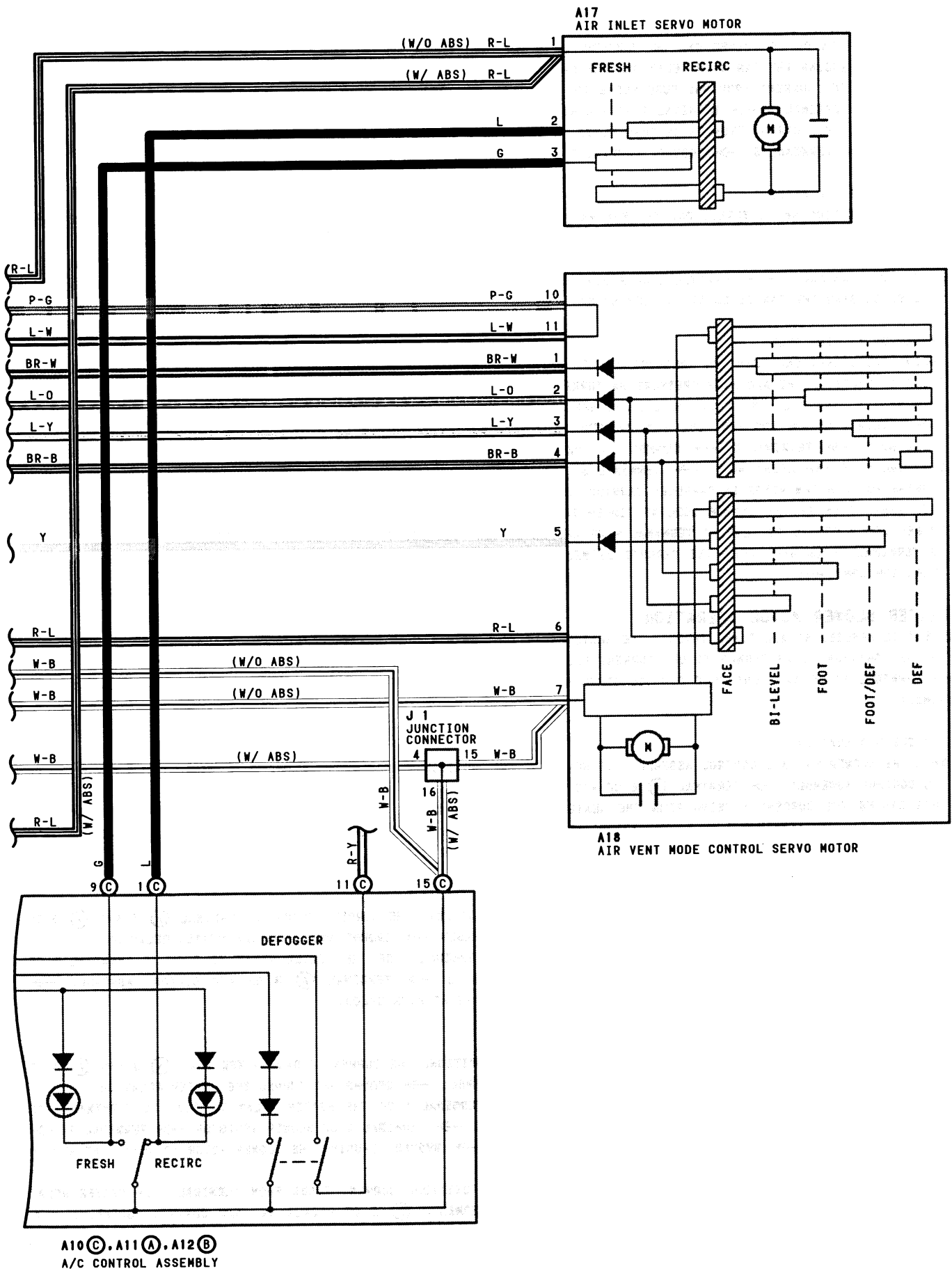



RADIATOR FAN AND AIR CONDITIONER

SYSTEM OUTLINE

1. COOLING FAN OPERATION

WHEN THE IGNITION SW IS TURNED ON, THE CURRENT FROM AM2 FUSE FLOWS TO TERMINAL 1 OF FAN MAIN RELAY → TERMINAL 3 → GROUND, CAUSING THE FAN MAIN RELAY OF EACH FAN TO TURN ON.

AT THAT TIME, THE CURRENT FROM AM2 FUSE FLOWS TO FAN RELAY NO.1 AND NO.2, AND FLOWS FROM TERMINAL 2 OF FAN RELAY NO.1 AND NO.2 → TERMINAL 1 → TERMINAL 2 OF A/C HIGH PRESSURE SW → TERMINAL 1 → TERMINAL 10 OF A/C AMPLIFIER. AT THE SAME TIME, THE CURRENT FROM GAUGE FUSE FLOWS TO TERMINAL 4 OF A/C AMPLIFIER → TERMINAL 3 → TERMINAL 2 OF FAN RELAY NO.3 → TERMINAL 3 → GROUND, CAUSING FAN RELAY NO.3 TO TURN ON.

• OPERATION AT LOW SPEED

WHEN THE IGNITION SW IS TURNED ON, THE FAN MAIN RELAY AND FAN RELAY NO.1, NO.2 AND NO.3 TURN ON, THE CURRENT FLOWS FROM ALT FUSE FLOWS TO TERMINAL 5 OF FAN MAIN RELAY → TERMINAL 4 → CDS FAN FUSE → TERMINAL 2 OF A/C CONDENSER FAN MOTOR → TERMINAL 1 → TERMINAL 5 OF FAN RELAY NO.2 → TERMINAL 1 → TERMINAL 4 OF FAN RELAY NO.3 → TERMINAL 1 → TERMINAL 2 OF RADIATOR FAN MOTOR → TERMINAL 1 → GROUND, FLOWING TO EACH FAN MOTOR IN SERIES, CAUSING THE FAN TO ROTATE AT LOW SPEED.

• OPERATION AT HIGH SPEED

DURING A/C OPERATION, WHEN THE PRESSURE OF A/C COMPRESSOR BECOMES HIGHER THAN NORMAL PRESSURE (MORE THAN 14.3KG/CM² 1401KPA. 203PSI), THE A/C HIGH PRESSURE SW TURNS OFF.

AS A RESULT, FAN RELAY NO.1 AND NO.2 TURNS OFF AND THE CURRENT FLOWS FROM ALT FUSE TO TERMINAL 5 OF FAN MAIN RELAY → TERMINAL 4 → CDS FAN FUSE → TERMINAL 2 OF A/C CONDENSER FAN MOTOR → TERMINAL 1 → TERMINAL 7 OF FAN RELAY NO.2 → TERMINAL 3 → GROUND, AT THE SAME TIME FROM TERMINAL 4 OF FAN MAIN RELAY TO RDI FAN FUSE → TERMINAL 4 OF FAN RELAY NO.1 → TERMINAL 3 → TERMINAL 2 OF RADIATOR FAN MOTOR → TERMINAL 1 → GROUND, FLOWING TO EACH FAN MOTOR IN PARALLEL CAUSING THE FAN TO ROTATE AT HIGH SPEED.

NOTE THAT, EVEN IF THE ENGINE COOLANT TEMPERATURE RISES ABOVE 90°C (194°F), THE WATER TEMP. SW (FOR RADIATOR FAN) TURNS OFF A SIGNAL IS SENT TO TERMINAL 9 OF A/C AMPLIFIER. BECAUSE CURRENT FLOW FROM TERMINAL 10 OF A/C AMPLIFIER TO TERMINAL 13 IS SHUT OFF, THE CIRCUIT BETWEEN THE A/C HIGH PRESSURE SW AND GROUND IS DEACTIVATED, SO THE SAME OPERATION CONTINUES.

2. HEATER BLOWER MOTOR OPERATION

CURRENT IS APPLIED AT ALL TIMES THROUGH THE HEATER FUSE TO TERMINAL 1 OF HEATER RELAY.

WHEN THE IGNITION SW IS TURNED ON, CURRENT FLOWS THROUGH GAUGE FUSE TO TERMINAL 5 OF HEATER RELAY → TERMINAL 3 → TERMINAL 10 OF AIR VENT MODE CONTROL SERVO MOTOR → TERMINAL 11 → TERMINAL (A) 4 AND (A) 5 OF A/C CONTROL ASSEMBLY.

• LOW SPEED OPERATION

WHEN THE BLOWER SW (A/C CONTROL ASSEMBLY) IS MOVED TO LOW POSITION, THE CURRENT FLOWS TO TERMINAL (A) 4 AND (A) 5 OF A/C CONTROL ASSEMBLY → TERMINAL (A) 6 OF A/C CONTROL ASSEMBLY → GROUND AND TURNS THE HEATER RELAY ON.

THIS CAUSES THE CURRENT FLOWING FROM THE HEATER FUSE TO TERMINAL 1 OF THE HEATER RELAY TO FLOW TO TERMINAL 2 OF HEATER RELAY → TERMINAL 1 OF BLOWER MOTOR → TERMINAL 2 → TERMINAL 1 OF BLOWER RESISTOR → TERMINAL 4 → GROUND, CAUSING THE BLOWER MOTOR TO ROTATE AT LOW SPEED.

• HIGH SPEED OPERATION

WHEN THE BLOWER SW (A/C CONTROL ASSEMBLY) IS MOVED TO HI POSITION, THE CURRENT FLOWS TO TERMINAL (A) 4 AND (A) 5 OF A/C CONTROL ASSEMBLY → TERMINAL (A) 6 OF A/C CONTROL ASSEMBLY → GROUND AND TURNS THE HEATER RELAY ON.

THIS CAUSES THE CURRENT FLOWING FROM THE HEATER FUSE TO TERMINAL 1 OF THE HEATER RELAY TO FLOW TO TERMINAL 2 OF HEATER RELAY → TERMINAL 1 OF BLOWER MOTOR → TERMINAL 2 → TERMINAL (A) 3 OF A/C CONTROL ASSEMBLY → TERMINAL (A) 6 → GROUND, CAUSING THE BLOWER MOTOR TO ROTATE AT HIGH SPEED.

• MEDIUM SPEED OPERATION (OPERATION AT M1, M2)

WHEN THE BLOWER SW (A/C CONTROL ASSEMBLY) IS MOVED TO M1 POSITION, THE CURRENT FLOWS TO TERMINAL (A) 4 AND (A) 5 OF A/C CONTROL ASSEMBLY → TERMINAL (A) 6 OF A/C CONTROL ASSEMBLY → GROUND AND TURNS THE HEATER RELAY ON.

THIS CAUSES THE CURRENT FLOWING FROM THE HEATER FUSE TO TERMINAL 1 OF THE HEATER RELAY TO FLOW TO TERMINAL 2 OF HEATER RELAY → TERMINAL 1 OF BLOWER MOTOR → TERMINAL 2 → TERMINAL 1 OF BLOWER RESISTOR → TERMINAL 2 → TERMINAL (A) 1 OF A/C CONTROL ASSEMBLY → TERMINAL (A) 6 → GROUND, CAUSING THE BLOWER MOTOR TO ROTATE AT MEDIUM LOW SPEED.

WHEN THE BLOWER SW (A/C CONTROL ASSEMBLY) IS MOVED TO M2 POSITION, CURRENT FLOWS FROM TERMINAL 1 OF HEATER RELAY → TERMINAL 1 OF BLOWER RESISTOR → TERMINAL 3 → TERMINAL (A) 2 OF BLOWER SW (A/C CONTROL ASSEMBLY) → TERMINAL (A) 6 → GROUND.

THIS CURRENT FLOW FROM BLOWER MOTOR TO GROUND IS GREATER THAN AT M1 POSITION, SO THE BLOWER MOTOR ROTATES AT MEDIUM HIGH SPEED.

3. OPERATION OF AIR INLET SERVO MOTOR

* SWITCHING FROM FRESH TO RECIRC

WITH THE IGNITION SW TURNED ON, THE CURRENT FLOWS FROM GAUGE FUSE TO TERMINAL 1 OF AIR INLET SERVO MOTOR.

WHEN THE RECIRC/FRESH SW IS SWITCHED TO THE RECIRC SIDE, THE CURRENT FLOWS FROM TERMINAL 1 OF AIR INLET SERVO MOTOR → TERMINAL 3 → TERMINAL ⓐ 9 OF A/C CONTROL ASSEMBLY → TERMINAL ⓐ 15 → GROUND, THE MOTOR ROTATES AND THE DAMPER MOVES TO THE RECIRC SIDE.

WHEN IT IS IN THE RECIRC POSITION, THE CURRENT IS CUT INSIDE THE SERVO MOTOR AND THE DAMPER STOPS AT THAT POSITION.

* SWITCHING FROM RECIRC TO FRESH

WITH IGNITION SW ON, WHEN THE RECIRC/FRESH SW IS SWITCHED TO THE FRESH SIDE, THE CURRENT FLOWS FROM TERMINAL 1 OF AIR INLET SERVO MOTOR → TERMINAL 2 → TERMINAL ⓐ 1 OF A/C CONTROL ASSEMBLY → TERMINAL ⓐ 15 → GROUND, THE MOTOR ROTATES AND THE DAMPER MOVES TO THE FRESH SIDE.

WHEN IT IS IN THE FRESH POSITION, THE CURRENT IS CUT INSIDE THE SERVO MOTOR AND THE DAMPER STOPS AT THAT POSITION.

4. OPERATION OF AIR VENT MODE CONTROL SERVO MOTOR

WITH IGNITION SW TURNED ON, THE CURRENT FLOWS FROM GAUGE FUSE TO TERMINAL 6 OF AIR VENT MODE CONTROL SERVO MOTOR → TERMINAL 7 → GROUND, AND THE DAMPER MOVES TO THE POSITION OF THE MODE SELECTION SW OF THE CONTROL ASSEMBLY SW.

WHEN THE MODE SELECTION SW OF A/C CONTROL ASSEMBLY IS MOVED TO DEF POSITION WITH THE DAMPER IN THE FACE POSITION, THE CURRENT FLOWS FROM TERMINAL 5 OF AIR VENT MODE CONTROL SERVO MOTOR TO TERMINAL ⓐ 14 OF A/C CONTROL ASSEMBLY → TERMINAL ⓐ 15 → GROUND.

AS A RESULT, THE SERVO MOTOR OPERATES UNTIL THE DAMPER REACHES DEF POSITION.

FOOT/DEF POSITION: THE CURRENT FLOWS FROM TERMINAL 4 OF SERVO MOTOR TO TERMINAL ⓐ 5 OF A/C CONTROL ASSEMBLY.

FOOT POSITION: THE CURRENT FLOWS FROM TERMINAL 3 OF SERVO MOTOR TO TERMINAL ⓐ 4 OF A/C CONTROL ASSEMBLY.

BI-LEVEL POSITION: THE CURRENT FLOWS FROM TERMINAL 2 OF SERVO MOTOR TO TERMINAL ⓐ 13 OF CONTROL ASSEMBLY.

5. AIR CONDITIONER OPERATION

THE A/C AMPLIFIER RECEIVES VARIOUS SIGNALS, THE ENGINE RPM SIGNAL FROM THE IGNITER OUTLET TEMPERATURE SIGNAL FROM THE A/C THERMISTOR AND CURRENT TEMPERATURE FROM THE WATER TEMP. SW, ETC.

WHEN THE ENGINE IS STARTED AND THE A/C SW (A/C CONTROL ASSEMBLY) IS TURNED ON, THE CURRENT FLOWS FROM A/C FUSE TO TERMINAL ⓑ 5 OF A/C CONTROL ASSEMBLY → TERMINAL ⓑ 6 → TERMINAL 6 OF A/C AMPLIFIER.

AT THIS TIME, THE A/C AMPLIFIER IS ACTIVATED AND CURRENT APPLIED FROM A/C FUSE TO TERMINAL 2 OF A/C MAGNET CLUTCH RELAY FLOWS FROM TERMINAL 3 OF A/C MAGNET CLUTCH RELAY → TERMINAL 11 OF A/C AMPLIFIER → TERMINAL 13 → GROUND. THIS CAUSES THE A/C MAGNET CLUTCH RELAY TO TURN ON, SO CURRENT APPLIED TO TERMINAL 1 OF A/C MAGNET CLUTCH RELAY FLOWS FROM TERMINAL 4 OF A/C MAGNET CLUTCH RELAY → TERMINAL 1 OF A/C MAGNET CLUTCH → GROUND, CAUSING THE A/C COMPRESSOR TO OPERATE.

WITH THE ACTIVATION OF A/C AMPLIFIER, CURRENT APPLIED FROM A/C FUSE TO TERMINAL 2 OF VSV (FOR A/C IDLE-UP) FLOWS FROM TERMINAL 1 OF VSV (FOR A/C IDLE-UP) → TERMINAL 1 OF A/C AMPLIFIER → TERMINAL 13 → GROUND, AND TURNS ON THE VSV TO AVOID LOWERING THE ENGINE RPM DURING AIR CONDITIONER OPERATION.

WHEN ANY OF THE FOLLOWING SIGNALS ARE INPUT TO THE A/C AMPLIFIER, THE AMPLIFIER OPERATES TO TURN OFF THE AIR CONDITIONER.

- * ENGINE HIGH RPM SIGNAL.
- * COOLANT HIGH TEMP. SIGNAL IS HIGH.
- * A SIGNAL THAT THE TEMPERATURE AT THE AIR OUTLET IS LOW.
- * A SIGNAL THAT THE REFRIGERANT PRESSURE IS ABNORMALLY HIGH OR LOW.



RADIATOR FAN AND AIR CONDITIONER

SERVICE HINTS

A14 A/C THERMISTOR

1-2: APPROX. 4852Ω AT 0°C (32°F)
 APPROX. 2341Ω AT 15°C (59°F)
 APPROX. 1500Ω AT 25°C (77°F)

A13 A/C DUAL PRESSURE SW

1-2: OPEN WITH PRESSURE LESS THAN 2.1KG/CM² (30PSI, 206KPA) OR ABOVE 27KG/CM² (384PSI, 2648KPA)

W 3 WATER TEMP. SW (FOR RADIATOR FAN)

1-2: OPEN ABOVE APPROX. 90°C (194°F)
 CLOSED BELOW APPROX. 83°C (181.4°F)

B 3 BLOWER RESISTOR

1-3: APPROX. 0.45Ω
 3-2: APPROX. 0.78Ω
 2-4: APPROX. 0.91Ω

A 9 A/C AMPLIFIER

4-GROUND: APPROX. 12VOLTS WITH IGNITION SW ON
 13-GROUND: ALWAYS CONTINUITY
 15-9 : CONTINUITY WITH WATER TEMP. SW CLOSED [BELOW APPROX. 83°C (181.4°F)]
 18-GROUND: APPROX. 12VOLTS WITH ENGINE RUNNING
 6-GROUND: APPROX. 12VOLTS WITH IGNITION SW ON AND A/C SW (A/C CONTROL ASSEMBLY) ON

A17 AIR INLET SERVO MOTOR

1-2: CLOSED WITH AIR INLET DAMPER AT RECIRC POSITION
 1-3: CLOSED WITH AIR INLET DAMPER AT FRESH POSITION

○ : PARTS LOCATION

CODE	SEE PAGE	CODE	SEE PAGE	CODE	SEE PAGE
A 3	20(5S-FE), 21(3S-GTE)	A17	22	E 6	B 20(5S-FE)
A 9	22	A18	22		C 20(5S-FE)
A10	C 22	A25	23	I11	22
A11	A 22	A26	23	J 1	22
A12	B 22	B 2	22	J 3	22
A13	22	B 3	22	R 5	23
A14	22	D 3	22	V 3	20(5S-FE), 21(3S-GTE)
A15	22	E 6	A 21(3S-GTE)	W 3	23

○ : RELAY BLOCKS

CODE	SEE PAGE	RELAY BLOCKS (RELAY BLOCK LOCATION)
1	18	R/B NO.1 (LEFT KICK PANEL)
5	17	R/B NO.5 (FRONT LUGGAGE COMPARTMENT RIGHT)

○ : JUNCTION BLOCK AND WIRE HARNESS CONNECTOR

CODE	SEE PAGE	JUNCTION BLOCK AND WIRE HARNESS (CONNECTOR LOCATION)
3A	19	COWL WIRE AND J/B NO.3 (BEHIND COMBINATION METER)
3C		
3D		

□ : CONNECTOR JOINING WIRE HARNESS AND WIRE HARNESS

CODE	SEE PAGE	JOINING WIRE HARNESS AND WIRE HARNESS (CONNECTOR LOCATION)
EA3	24(5S-FE) 26(3S-GTE)	ENGINE WIRE AND ENGINE ROOM MAIN WIRE (R/B NO.2 INNER)
IE1	28	ENGINE ROOM MAIN WIRE AND COWL WIRE (LEFT KICK PANEL)
IE3		
IE4		
IH1	28	COWL WIRE AND A/C SUB WIRE (INSTRUMENT PANEL RIGHT)
II2	30	LUGGAGE ROOM WIRE AND COWL WIRE (RIGHT KICK PANEL)
II3	30	COWL WIRE AND LUGGAGE ROOM WIRE (RIGHT KICK PANEL)
II4		

▽ : GROUND POINTS

CODE	SEE PAGE	GROUND POINTS LOCATION
IB	28	LEFT KICK PANEL
IC	28	INSTRUMENT PANEL BRACE LH
ID	28	RIGHT KICK PANEL
BE	32	FRONT RIGHT FENDER

○ : SPLICE POINTS

CODE	SEE PAGE	WIRE HARNESS WITH SPLICE POINTS	CODE	SEE PAGE	WIRE HARNESS WITH SPLICE POINTS
E 3	24(5S-FE)	ENGINE ROOM MAIN WIRE	I11	30	COWL WIRE
	26(3S-GTE)		I17	30	A/C SUB WIRE
I 9	30	COWL WIRE	B 3	32	LUGGAGE ROOM WIRE
I10			B 4		

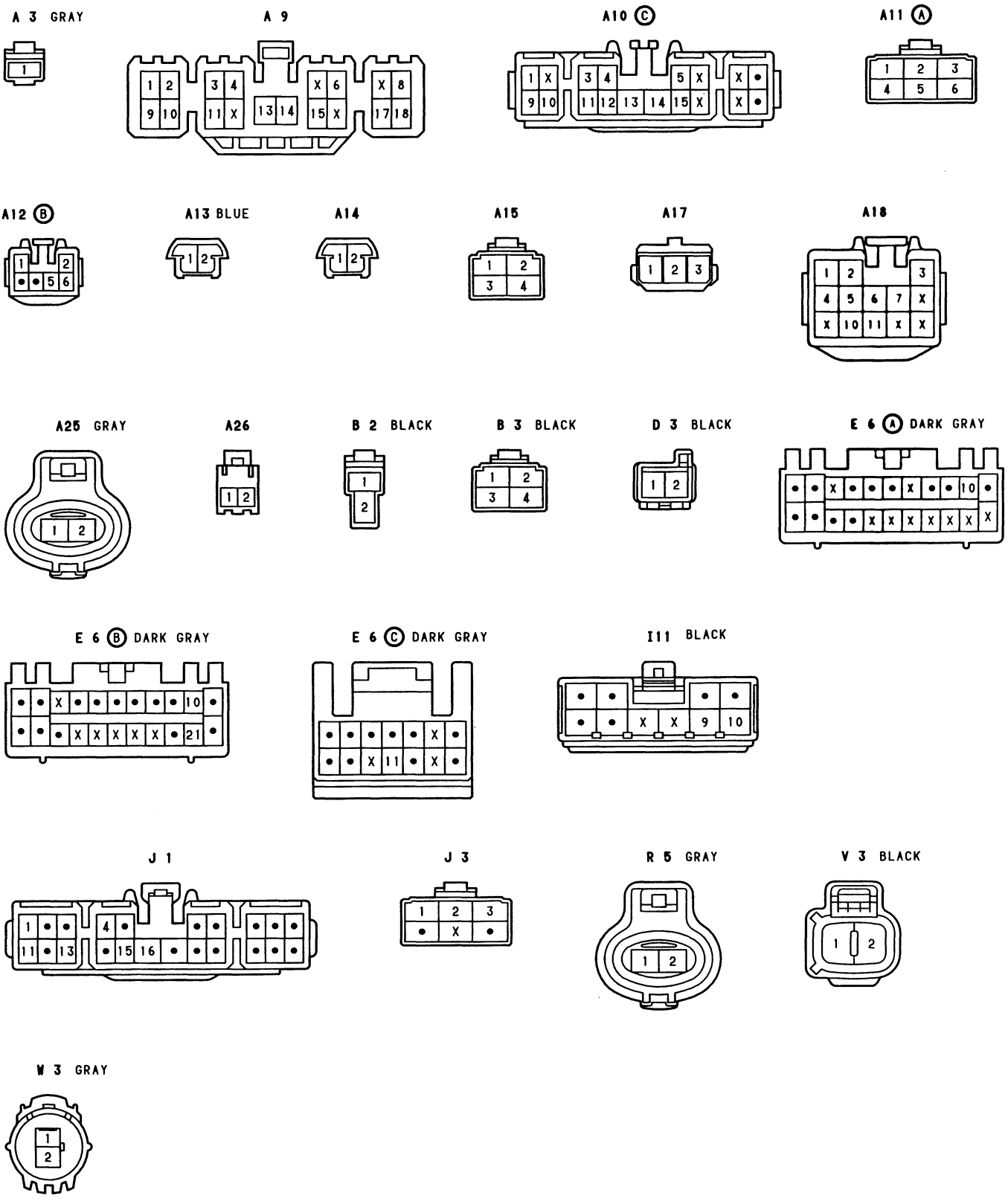

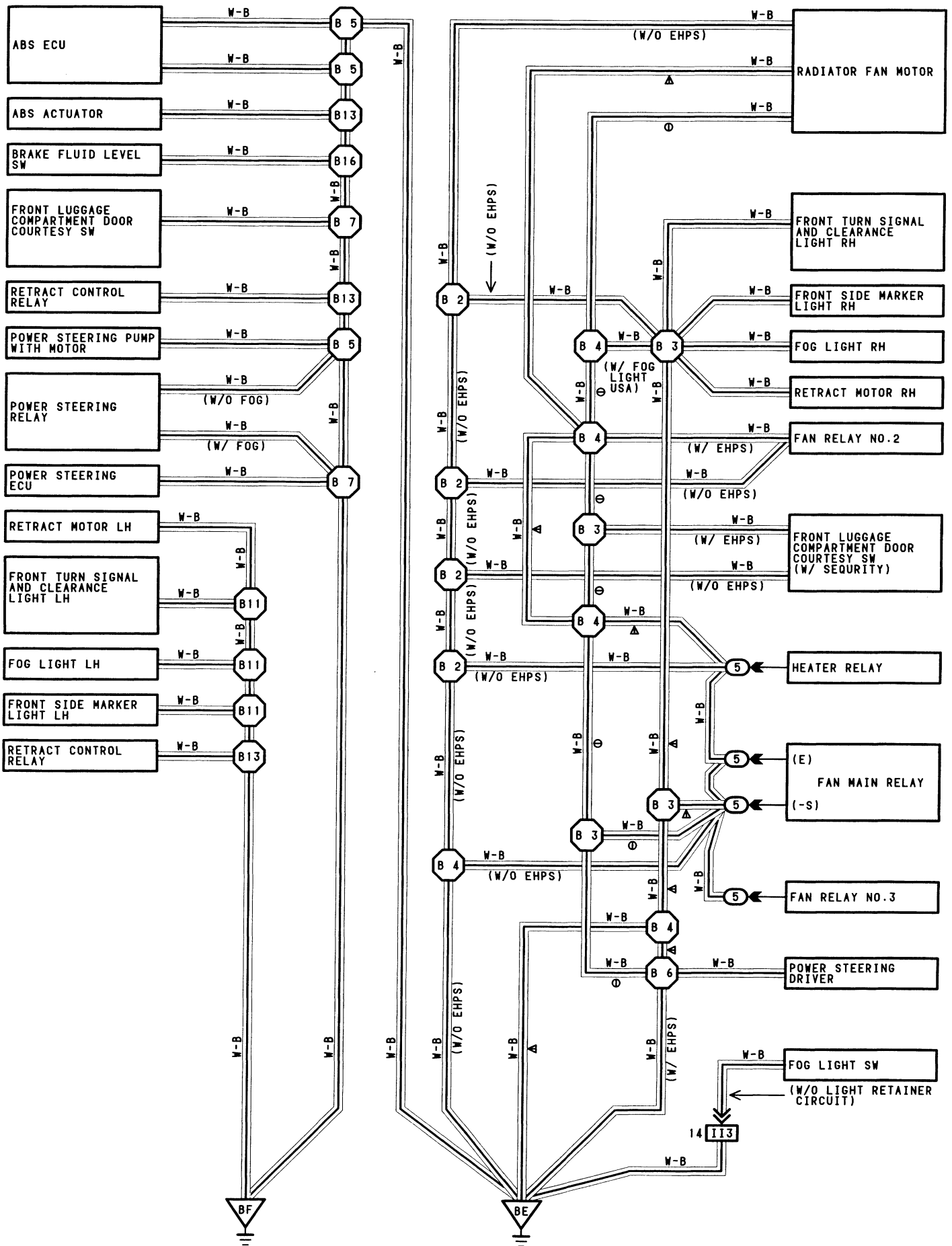

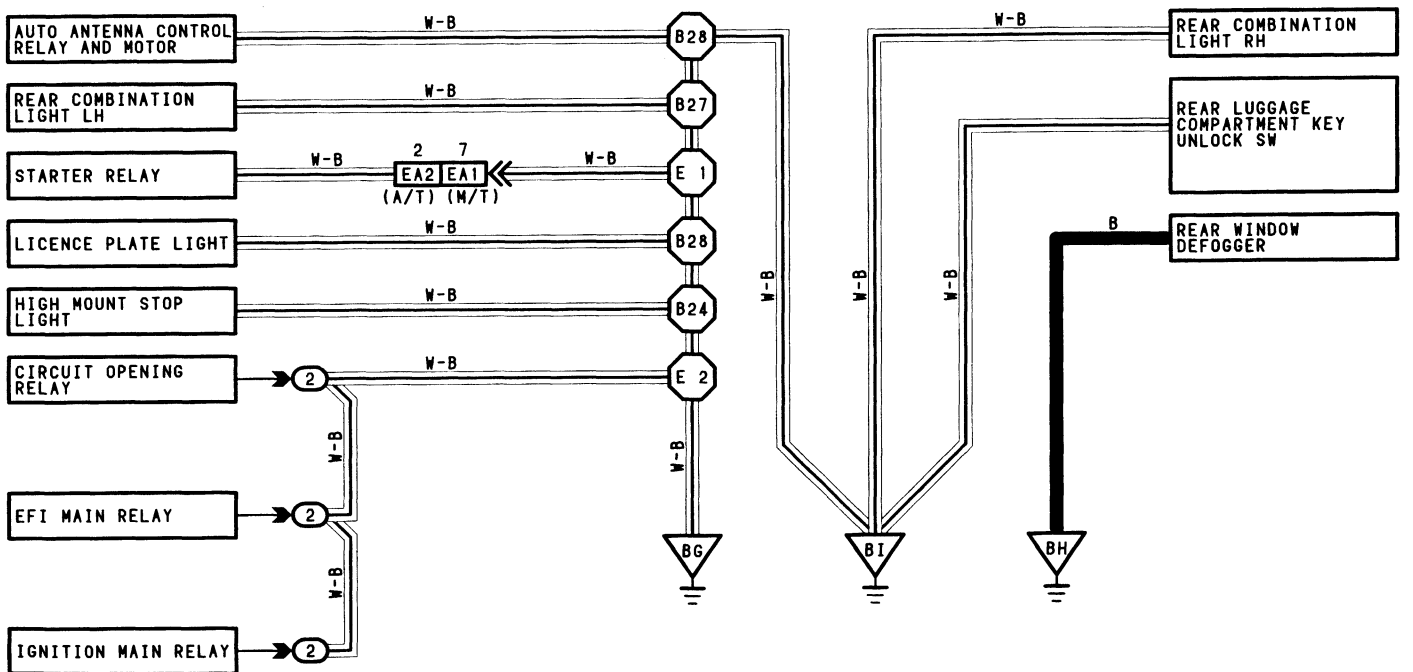
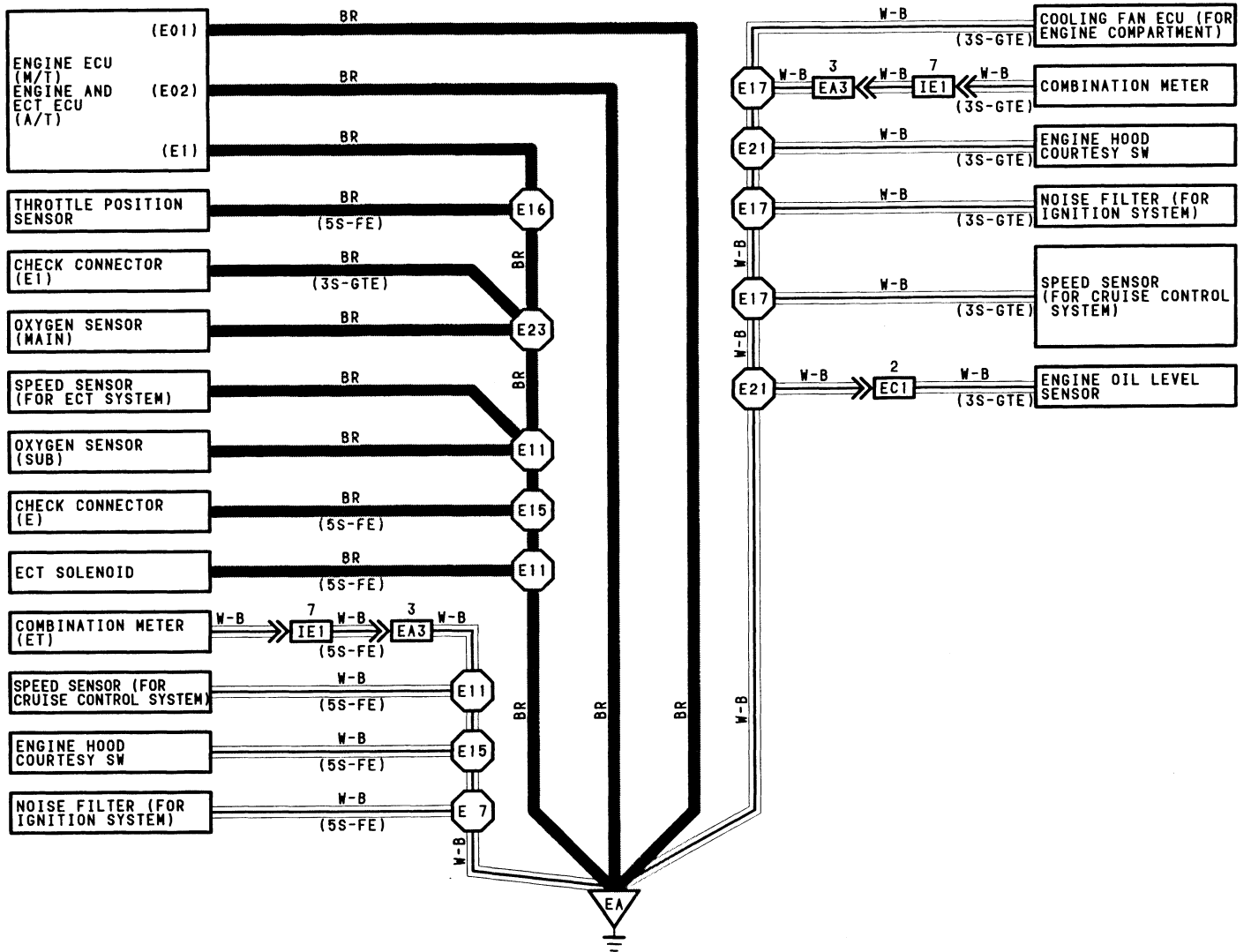

J GROUND POINT

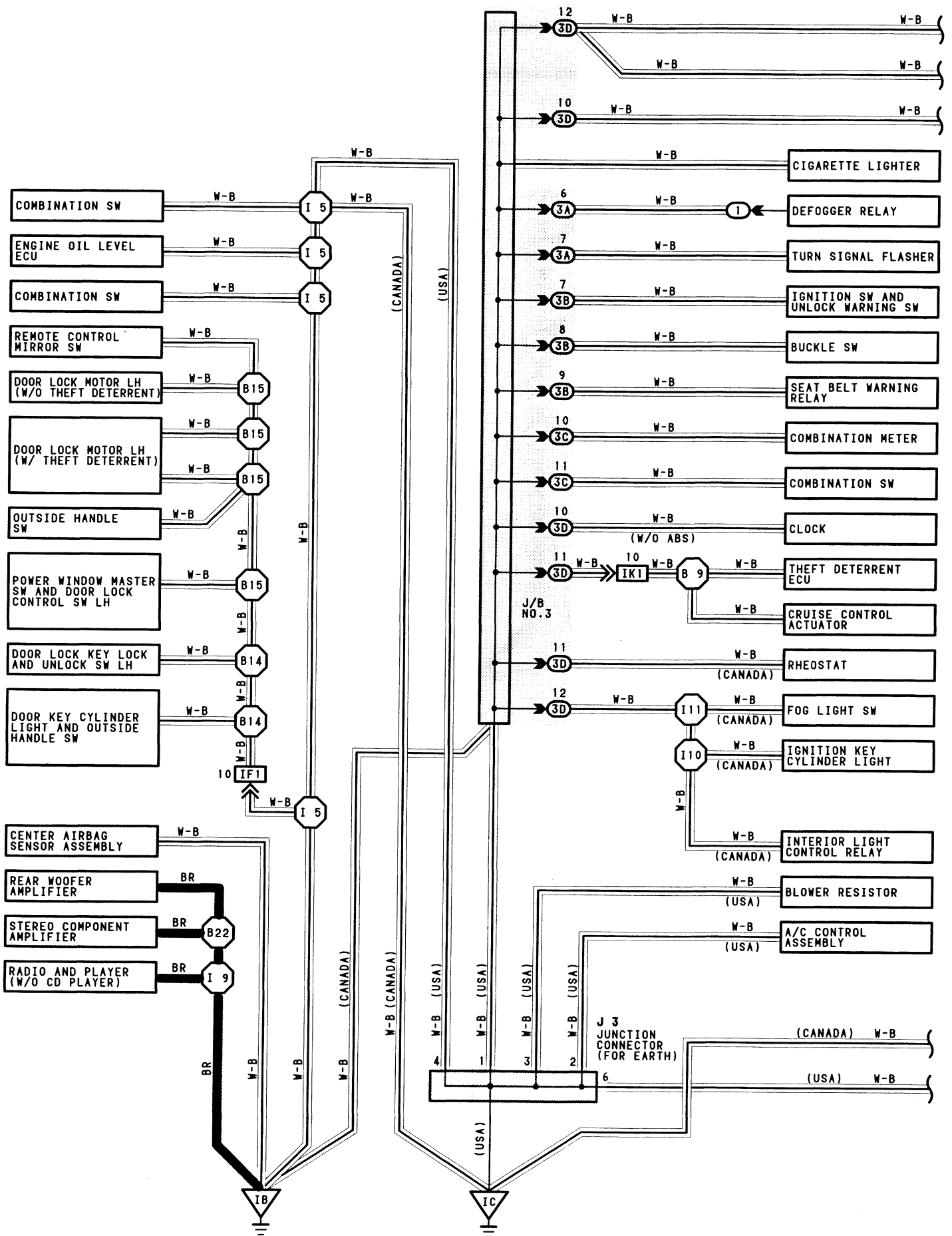

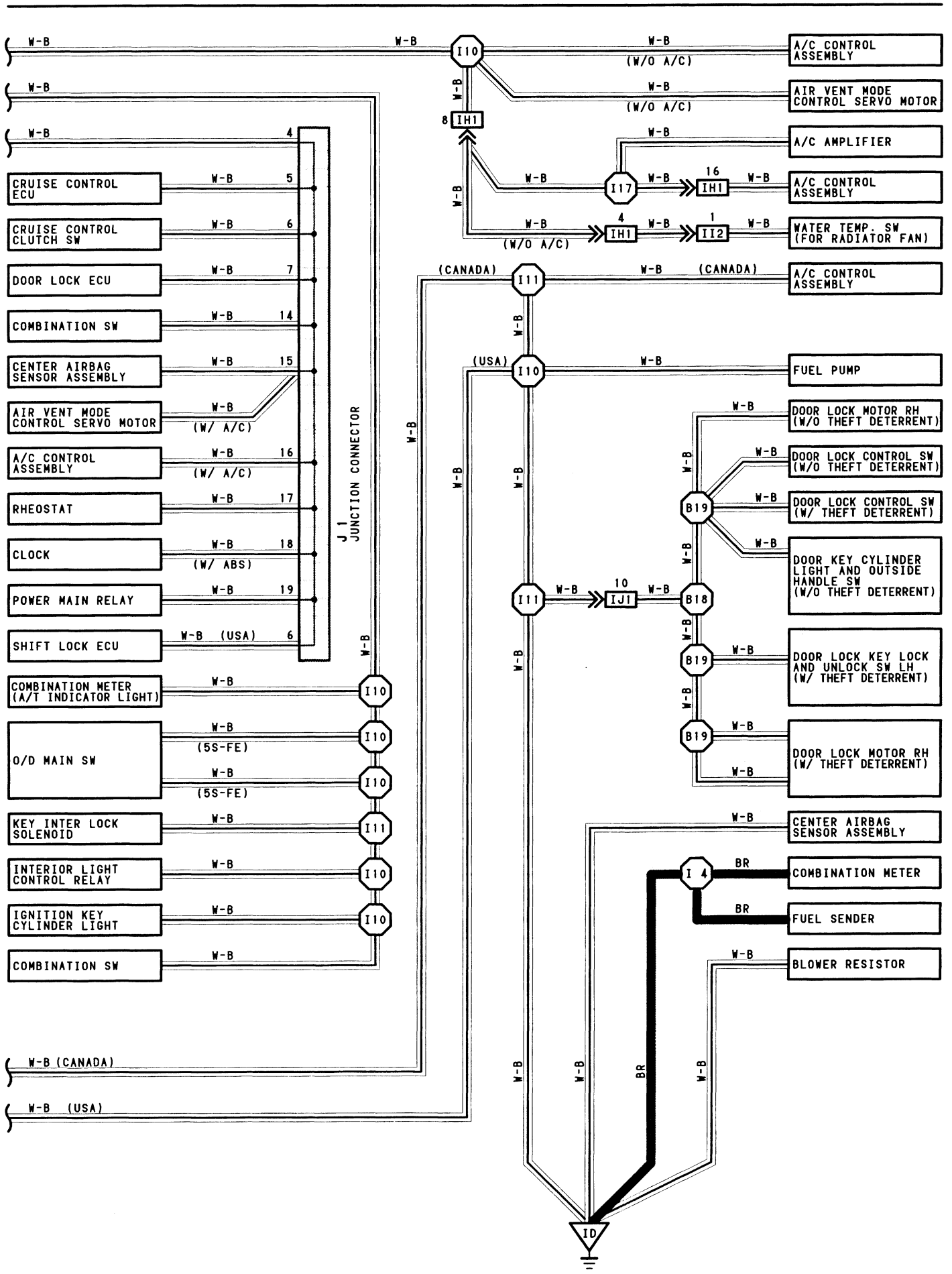

J GROUND POINT

○ : PARTS LOCATION

CODE	SEE PAGE	CODE	SEE PAGE	CODE	SEE PAGE
J 1	22	J 3	22		

○ : RELAY BLOCKS

CODE	SEE PAGE	RELAY BLOCKS (RELAY BLOCK LOCATION)
1	18	R/B NO.1 (LEFT KICK PANEL)
2	18	R/B NO.2 (ENGINE COMPARTMENT LEFT)
5	17	R/B NO.5 (FRONT LUGGAGE COMPARTMENT RIGHT)

○ : JUNCTION BLOCK AND WIRE HARNESS CONNECTOR

CODE	SEE PAGE	JUNCTION BLOCK AND WIRE HARNESS (CONNECTOR LOCATION)
3A	19	COWL WIRE AND J/B NO.3 (BEHIND COMBINATION METER)
3B		
3C		
3D		

□ : CONNECTOR JOINING WIRE HARNESS AND WIRE HARNESS

CODE	SEE PAGE	JOINING WIRE HARNESS AND WIRE HARNESS (CONNECTOR LOCATION)
EA1	24(5S-FE) 26(3S-GTE)	ENGINE WIRE AND ENGINE ROOM MAIN WIRE (REAR LUGGAGE COMPARTMENT LEFT)
EA2	24(5S-FE)	
EA3	24(5S-FE) 26(3S-GTE)	ENGINE WIRE AND ENGINE ROOM MAIN WIRE (R/B NO.2 INNER)
EC1	26(3S-GTE)	ENGINE NO.4 WIRE AND ENGINE WIRE (NEAR THE INTAKE MANIFOLD)
IE1	28	ENGINE ROOM MAIN WIRE AND COWL WIRE (LEFT KICK PANEL)
IF1	28	COWL WIRE AND FRONT DOOR LH WIRE (LEFT KICK PANEL)
IH1	28	COWL WIRE AND A/C SUB WIRE (INSTRUMENT PANEL RIGHT)
II2	30	LUGGAGE ROOM WIRE AND COWL WIRE (RIGHT KICK PANEL)
II3	30	COWL WIRE AND LUGGAGE ROOM WIRE (RIGHT KICK PANEL)
IJ1	30	COWL WIRE AND FRONT DOOR RH WIRE (RIGHT KICK PANEL)
IK1	30	FLOOR WIRE AND COWL WIRE (RIGHT KICK PANEL)

▽ : GROUND POINTS

CODE	SEE PAGE	GROUND POINTS LOCATION
EA	24(5S-FE) 26(3S-GTE)	INTAKE MANIFOLD
IB	28	LEFT KICK PANEL
IC	28	INSTRUMENT PANEL BRACE LH
ID	28	RIGHT KICK PANEL
BE	32	FRONT RIGHT FENDER
BF	32	FRONT LEFT FENDER
B6	32	UNDER THE LEFT CENTER PILLAR
BH	32	UNDER THE RIGHT REAR PILLAR
BI	32	BACK PANEL CENTER

○ : SPLICE POINTS

CODE	SEE PAGE	WIRE HARNESS WITH SPLICE POINTS	CODE	SEE PAGE	WIRE HARNESS WITH SPLICE POINTS		
E 1	24(5S-FE)	ENGINE ROOM MAIN WIRE	B 3	32	LUGGAGE ROOM WIRE		
	26(3S-GTE)		B 4				
E 2	24(5S-FE)	ENGINE WIRE	B 5				
	26(3S-GTE)		B 6				
E 7	24(5S-FE)	ENGINE WIRE	B 7				
E11			B 9			32	FLOOR WIRE
E15			B11			32	LUGGAGE ROOM WIRE
E16			B13	32	LUGGAGE ROOM WIRE		
E17			B14	32	FRONT DOOR RH WIRE		
E21	26(3S-GTE)	COWL WIRE	B15	32	LUGGAGE ROOM WIRE		
E23			B16	32	FRONT DOOR LH WIRE		
I 4	30	COWL WIRE	B18	32	COWL WIRE		
I 5			B19	32	ENGINE ROOM MAIN WIRE		
I 9			B22	32	LUGGAGE ROOM WIRE		
I10			B24	32	LUGGAGE ROOM WIRE		
I11			B27	32	LUGGAGE ROOM WIRE		
I17	30	A/C SUB WIRE	B28	32	LUGGAGE ROOM WIRE		
B 2	32	LUGGAGE ROOM WIRE					

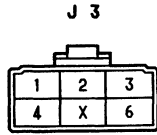
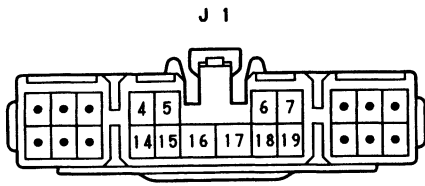

K OVER ALL ELECTRICAL WIRING DIAGRAM

HOW TO READ THIS SECTION

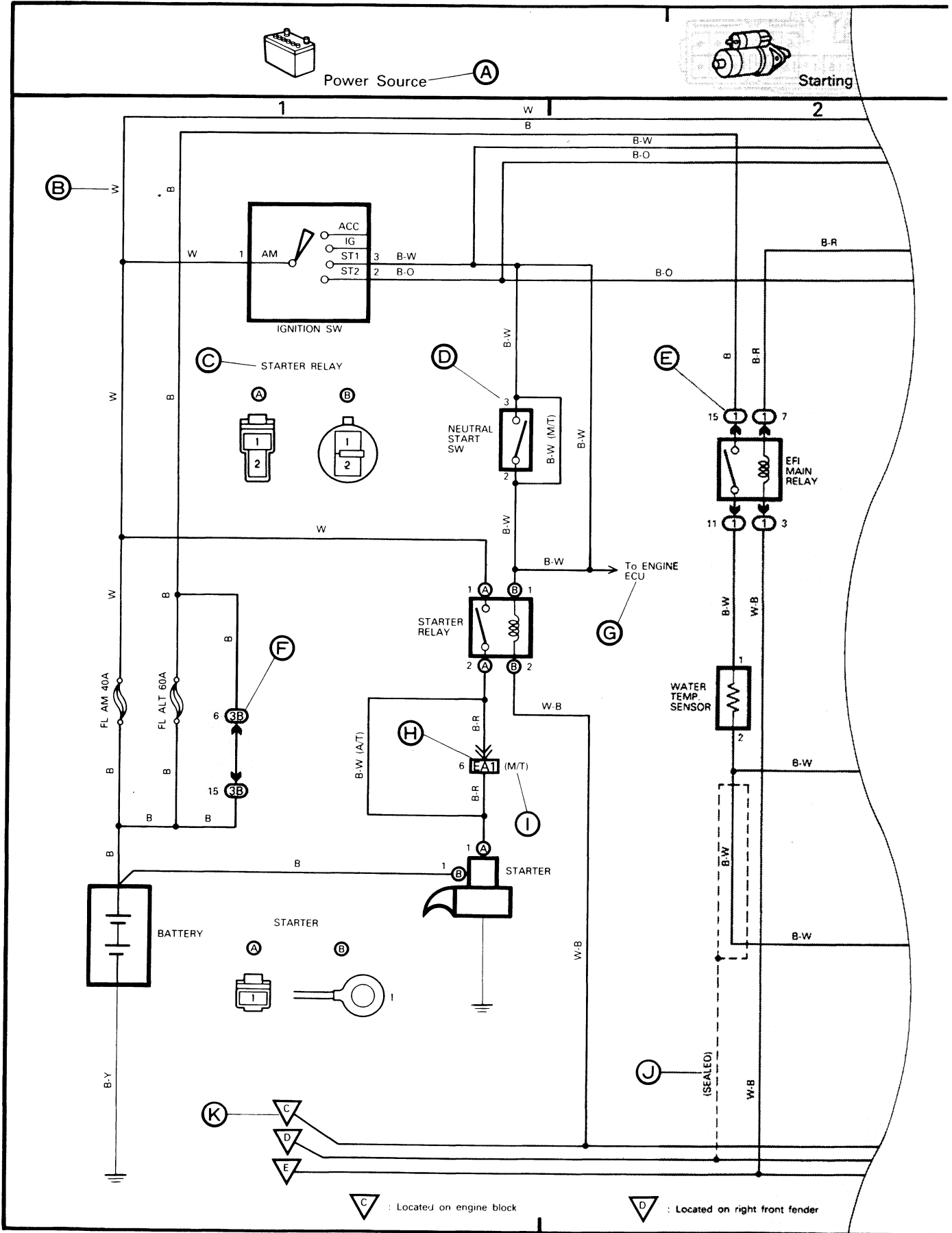

(A): System Title

(B): Indicates the wiring color.

Wire colors are indicated by an alphabetical code.

B = Black	L = Blue	R = Red
BR = Brown	LG = Light Green	V = Violet
G = Green	O = Orange	W = White
GR = Gray	P = Pink	Y = Yellow

The first letter indicates the basic wire color and the second letter indicates the color of the stripe.

Example: L - Y

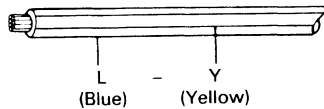

(C): Indicates the connector to be connected to a part (the numeral indicates the pin No.)

(D): Indicates the pin number of the connector. The numbering system is different for female and male connectors.

Example: Numbered in order from upper left to lower right Numbered in order from upper right to lower left



The numbering system for the overall wiring diagram is the same as above.

(E): Indicates a Relay Block. No shading is used and only the Relay Block No. is shown to distinguish it from the J/B.

Example: ① Indicates Relay Block No. 1.

(F): Junction Block (The number in the circle is the J/B No. and the connector code is shown beside it). Junction Blocks are shaded to clearly separate them from other parts (different junction blocks are shaded differently for further clarification).

Example:

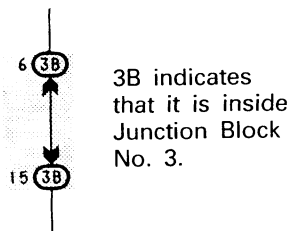

(G): Indicates related system.

(H): Indicates the wiring harness and wiring harness connector. The wiring harness with male terminal is shown with arrows (↘). Outside numerals are pin numbers.

- All connectors are shown from the open end, and the lock is on top.

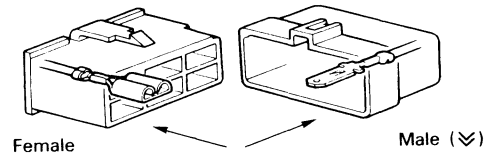

























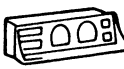

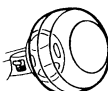

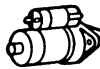

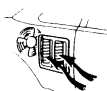
(I): () are used to indicate different wiring and connector, etc. when the vehicle model, engine type, or specification is different.

(J): Indicates a sealed wiring harness.

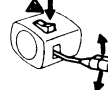

(K): Indicates a ground point.

SYSTEMS	LOCATION	SYSTEMS	LOCATION
ABS (Anti-Lock Brake System)	 13-2	Ignition	 1-3
Air Conditioner, Cooler and Heater	 21-4	Interior Lights	 9-2
Auto Antenna	 16-2	Power Source	 1~21, -1
Automatic Transmission Indicator	 2-2	Power Windows	 12-3
Back-up Lights	 2-3	Radiator Fan and Condenser Fan	 21-2
Charging	 1-4	Radio and Player	 17-2 (w/ CD) 18-2 (w/o CD)
Cigarette Lighter	 16-3	Rear Window Defogger	 16-4
Clock	 16-3	Remote Control Mirrors	 12-2
Combination Meter	 20-2	Shift Lock	 14-4
Cruise Control	 10-2	SRS Airbag	 14-2
Door Locks	 19-2	Starting	 1-2
EHPS (Electro Hydraulic Power Steering)	 15-2	Stop Lights	 10-6
Engine Compartment Cooling Fan	 2-4	Taillights and Illumination	 6-2
Engine Control and ECT	 3-2 (3S-GTE) 4-2 (5S-FE A/T w/ ECT) 5-2 (5S-FE M/T)	Theft Deterrent System	 19-4
Fog Lights	 8-2	Turn Signal and Hazard	 11-2
Front Wiper and Washer	 8-3	Unlock and Seat Belt Warning	 9-4
Headlight	 7-2		
Horn	 11-4		

MR2 ELECTRICAL WIRING DIAGRAM-1991 Model (Page 1 to Page 22)



Power Source

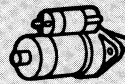

Starting

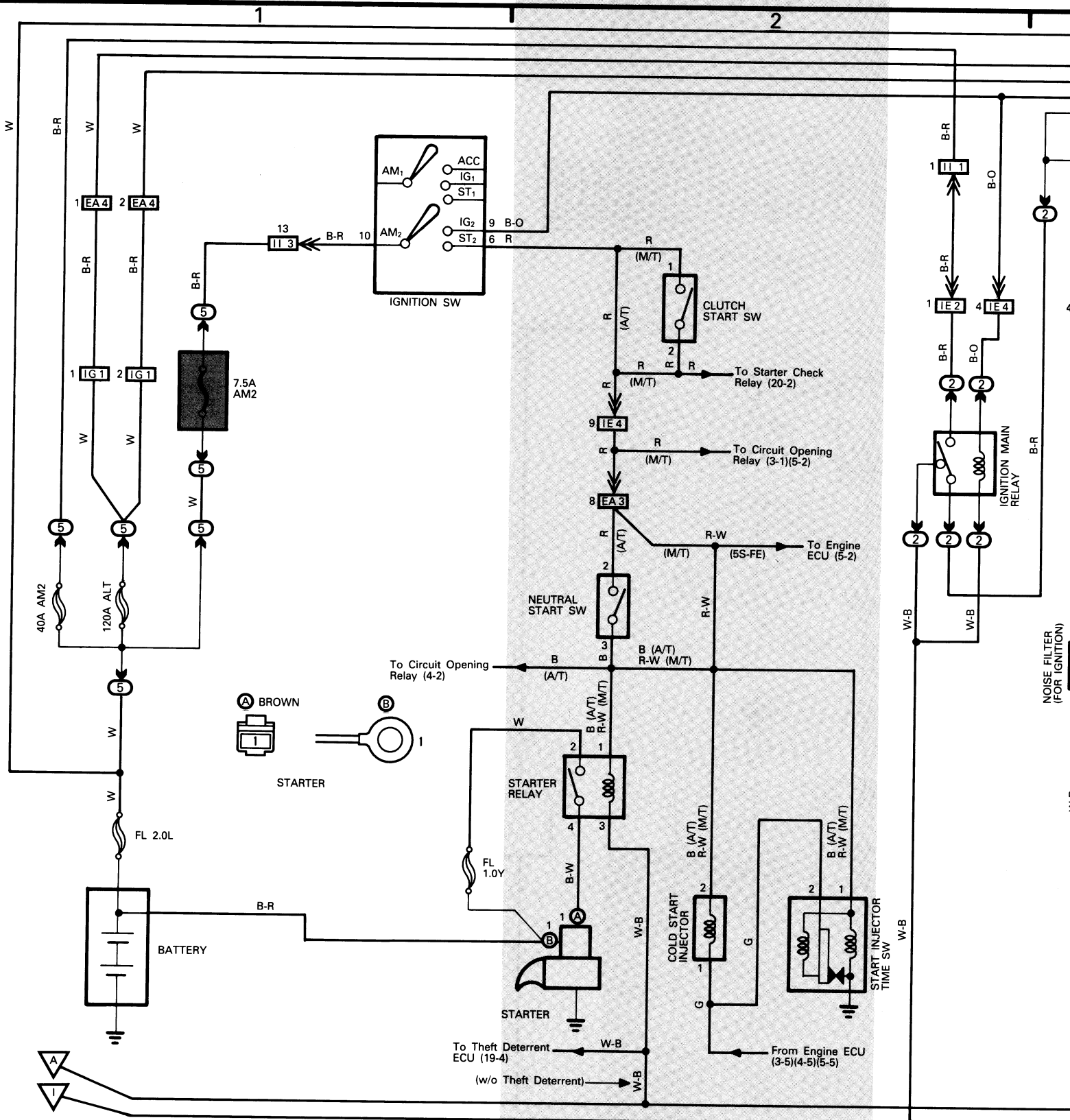

Ground points

= Located on intake manifold

= Located on back panel center

* See last fold-out page for connector to J/B, and connector between wire harness.



Ignition



Charging

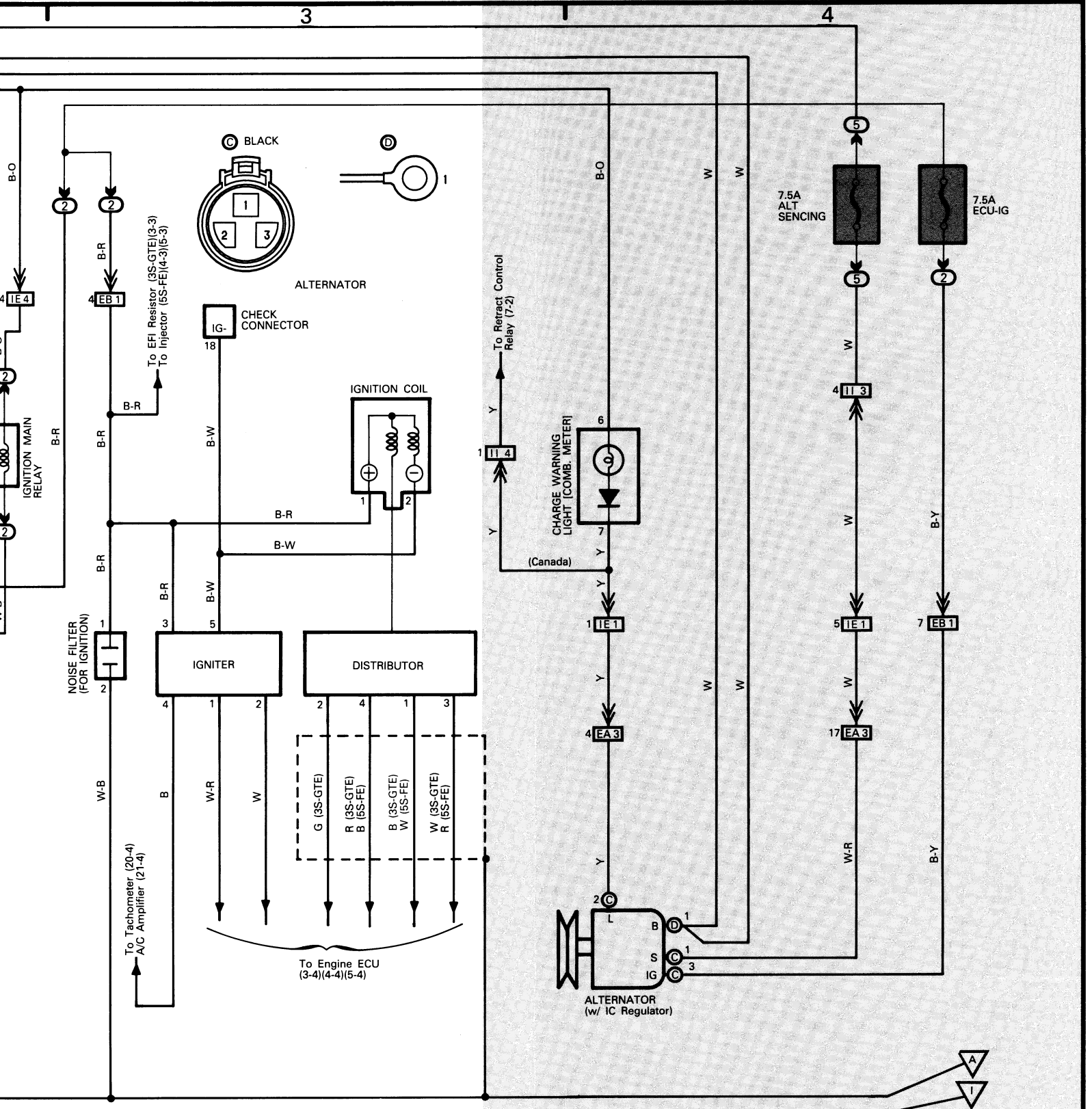

2 MR2 (Cont'd)

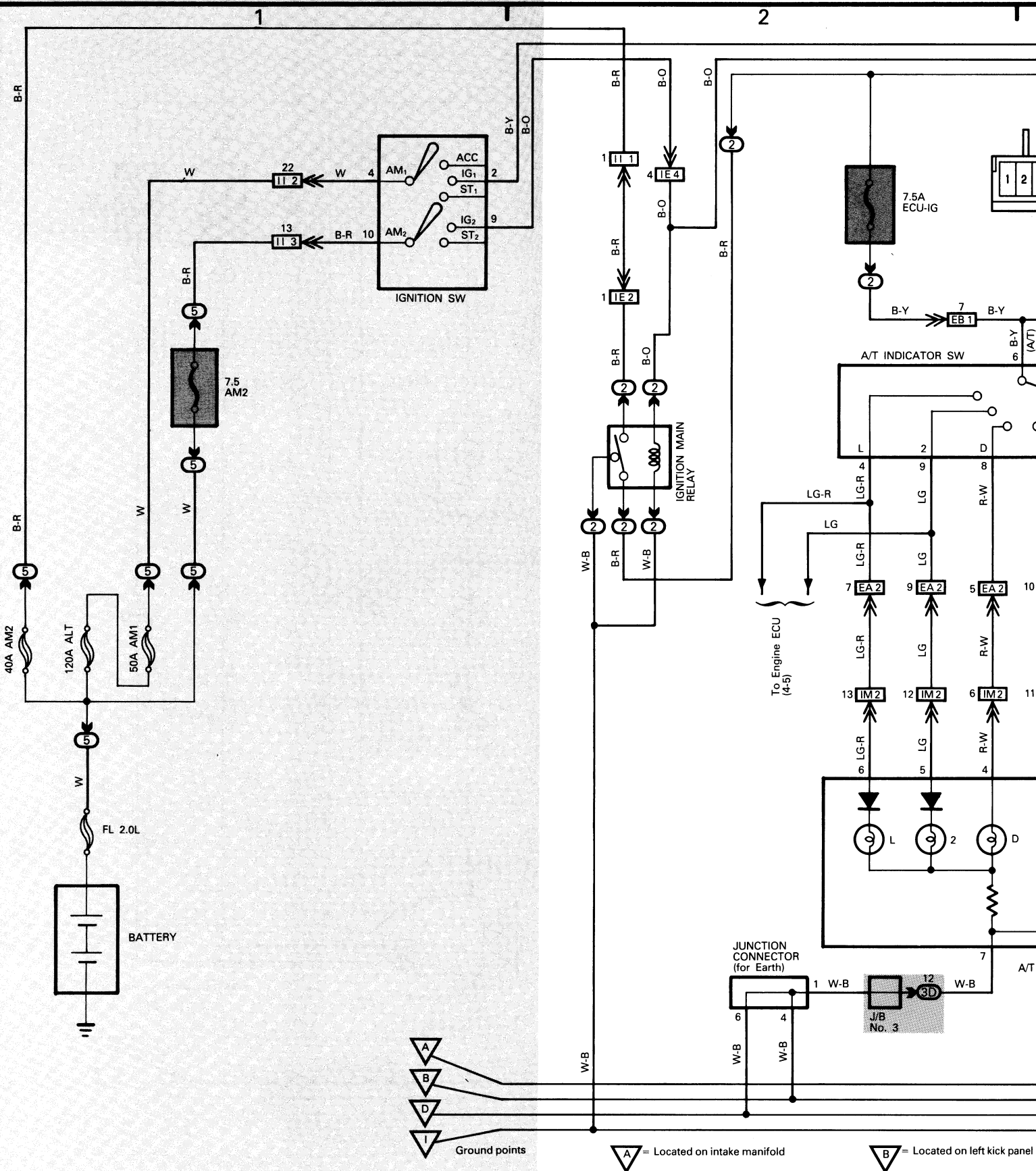
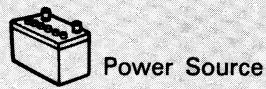

Indicator



Back-up Lights



Engine Compartment Cooling Fan

3

4

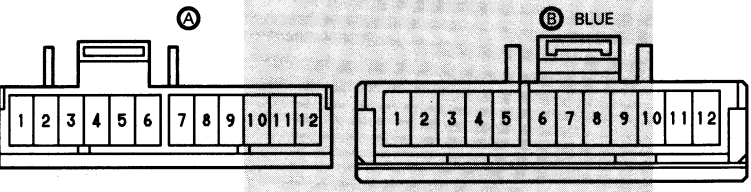

COOLING FAN WARNING LIGHT

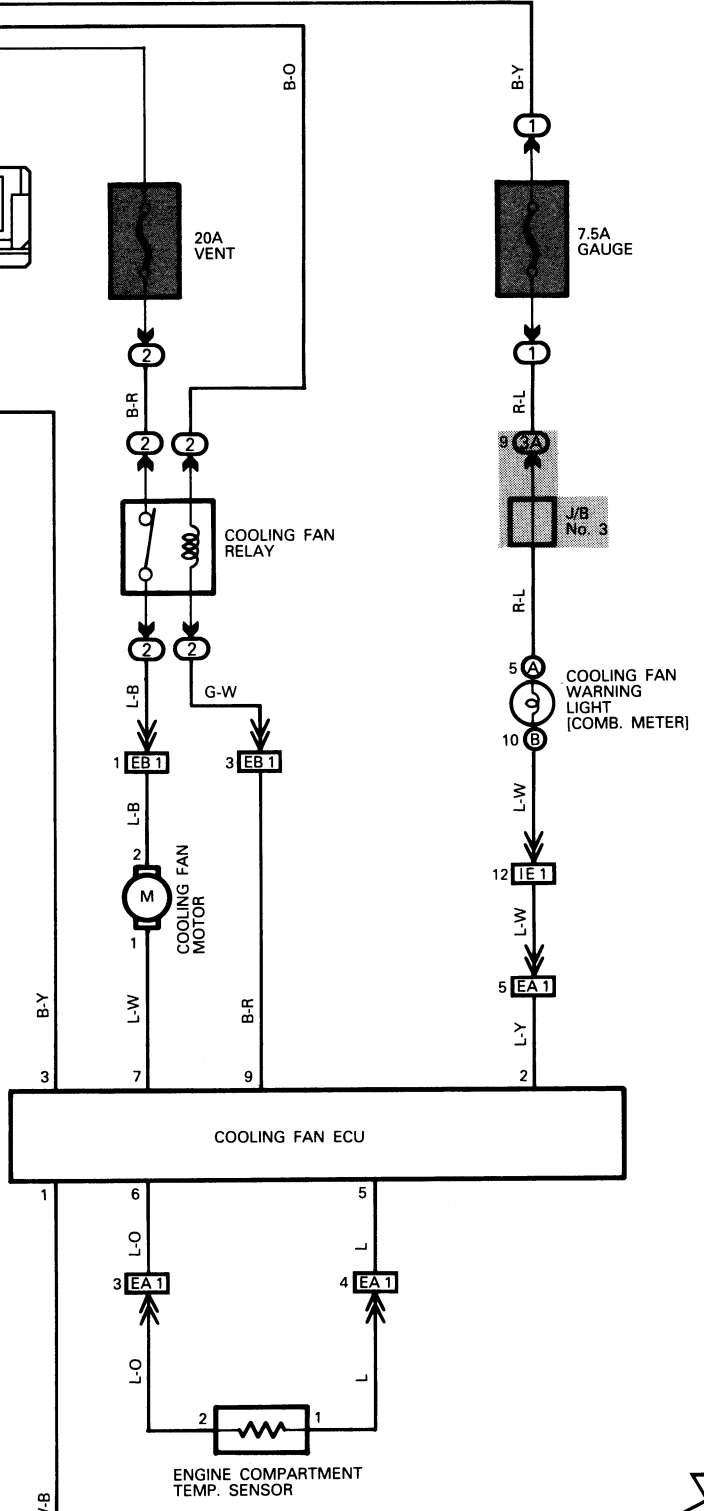
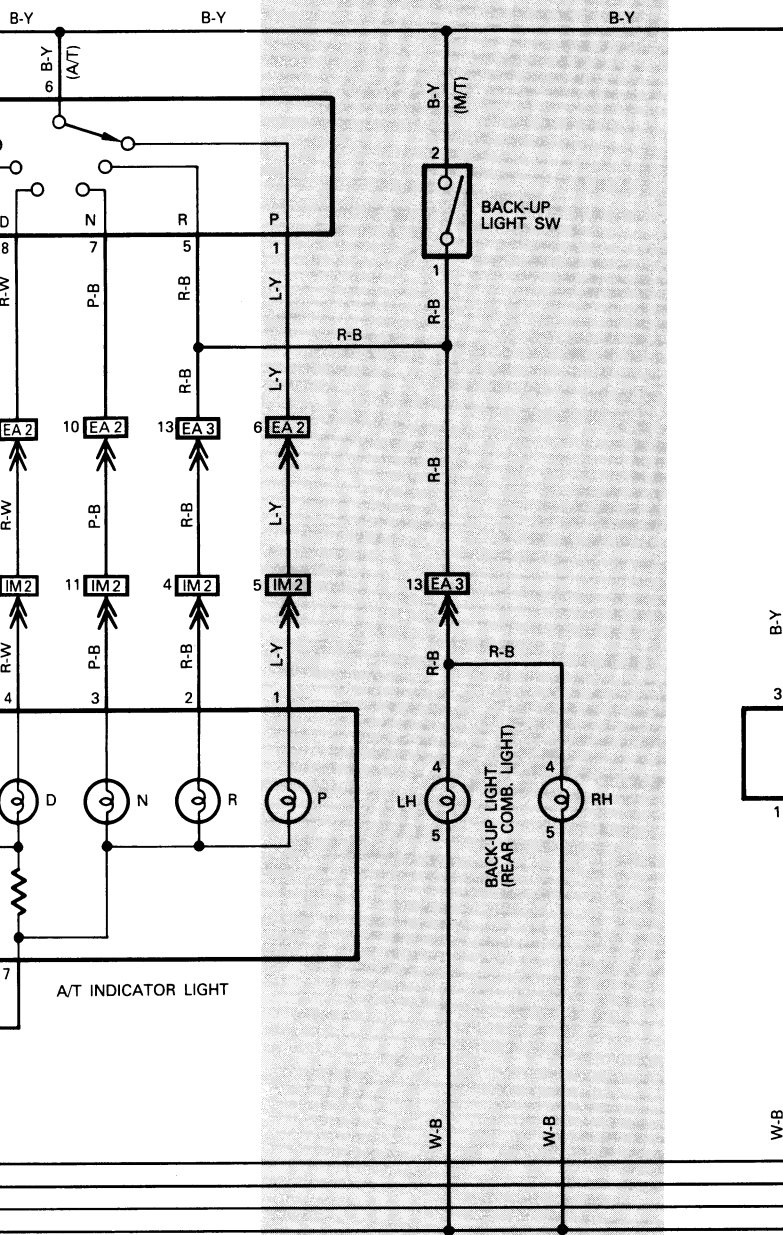

left kick panel

= Located on right kick panel

= Located on back panel center

* See last fold-out page for connector to J/B, and connector between wire harness.



MR2 (Cont'd)



Power Source

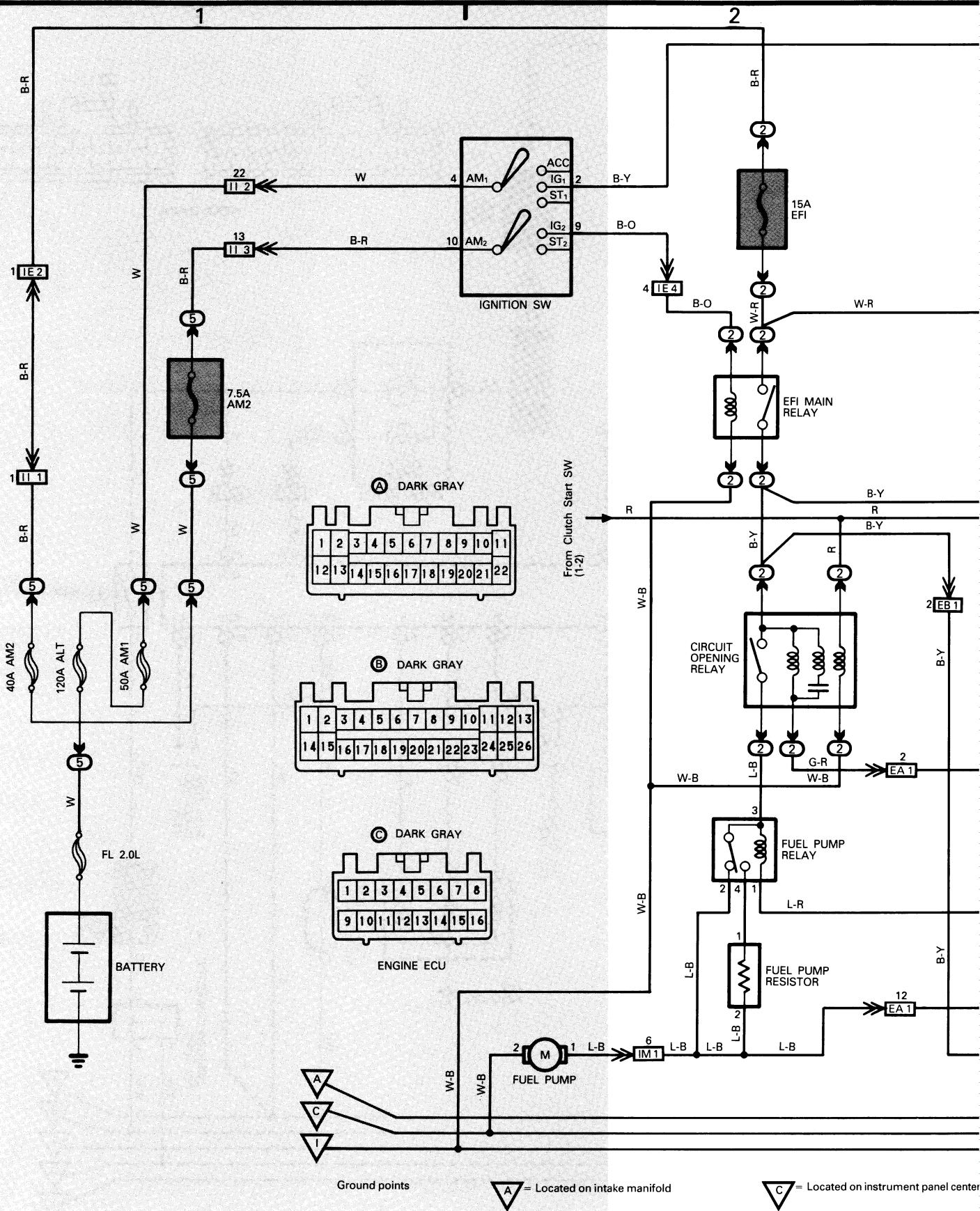



3

4

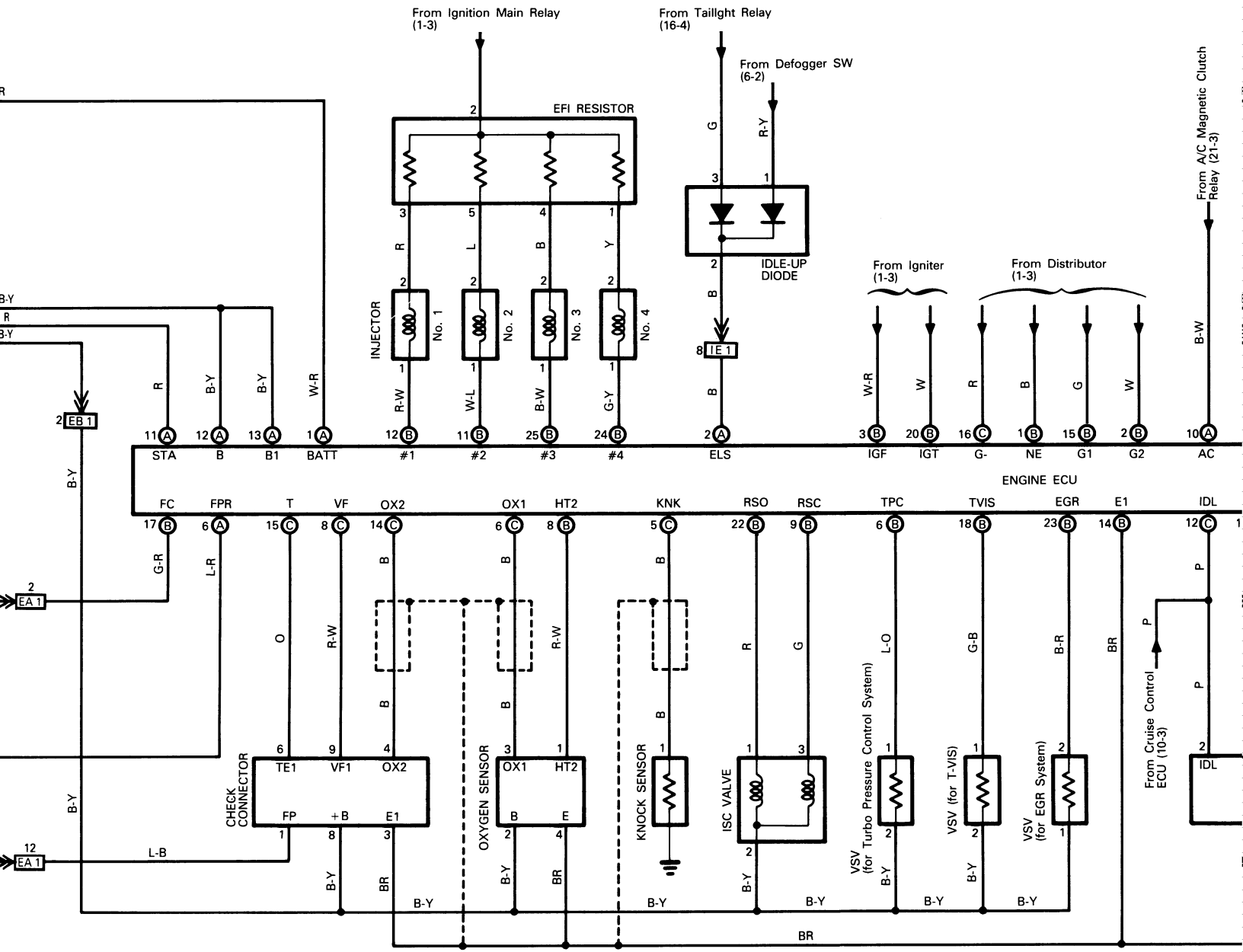

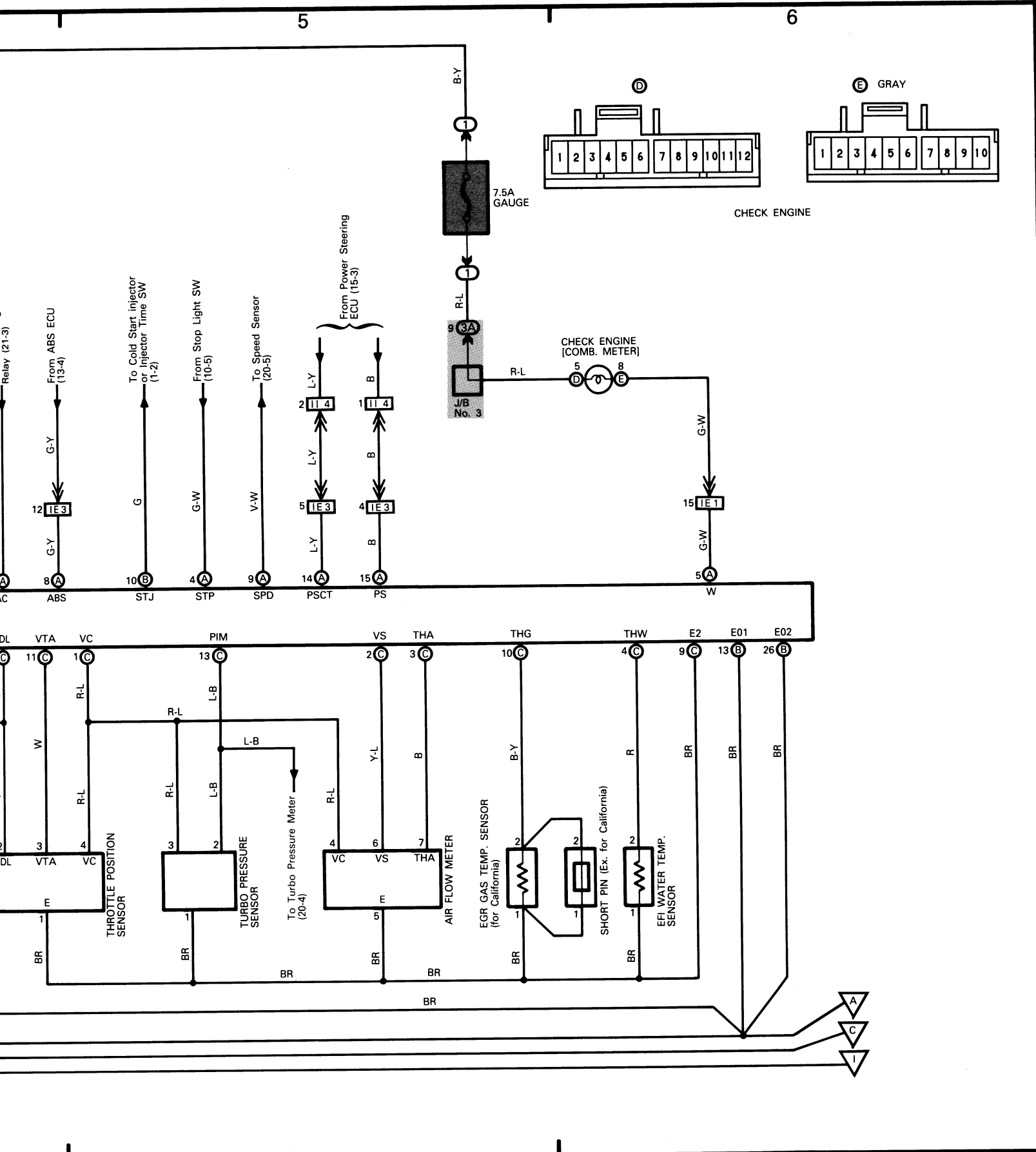

4 MR2 (Cont'd)



Power Source

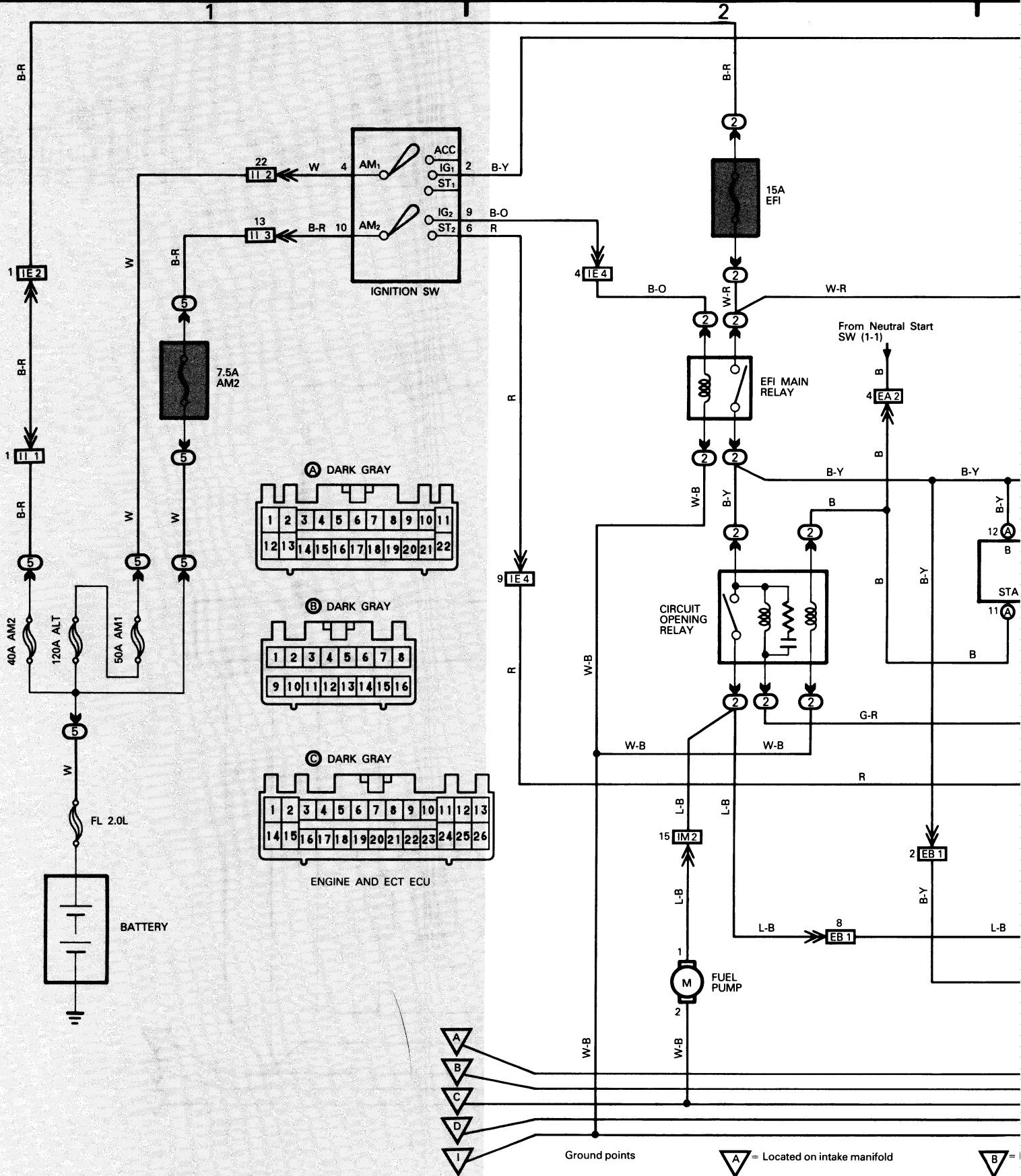



Engine Control and ECT (5S-FE A/T)

3

4

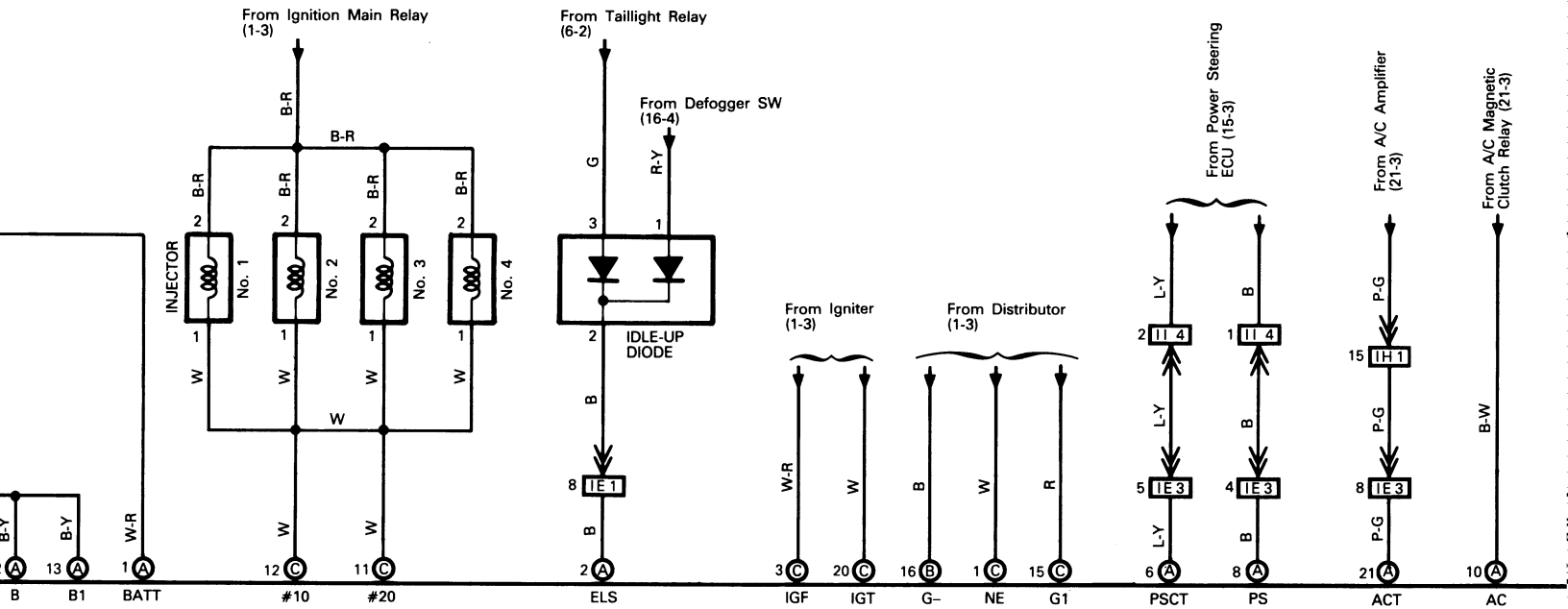

ENGINE AND ECT ECU

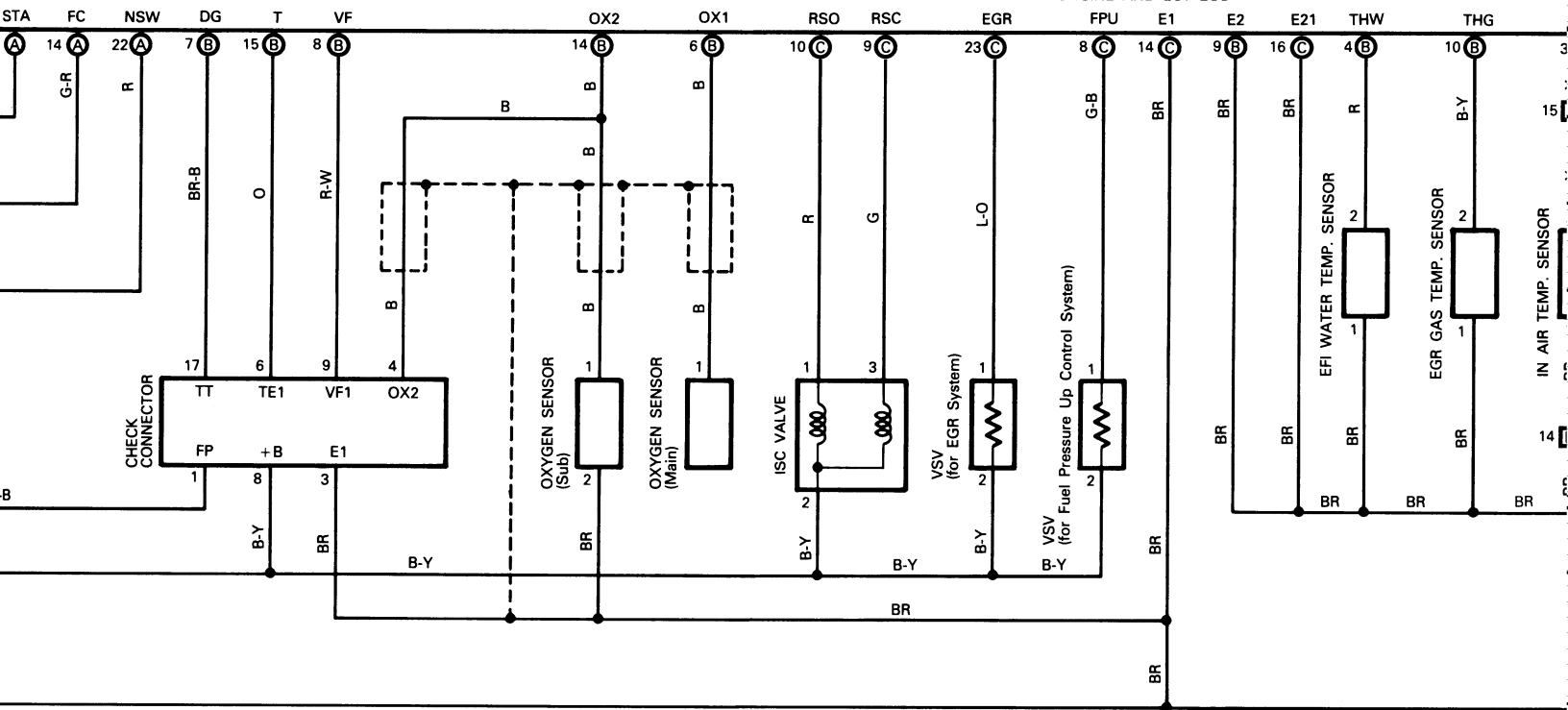

7 = Located on left kick panel

C = Located on instrument panel center

D = Located on right kick panel

I = Located on back panel center

* See last page and connector

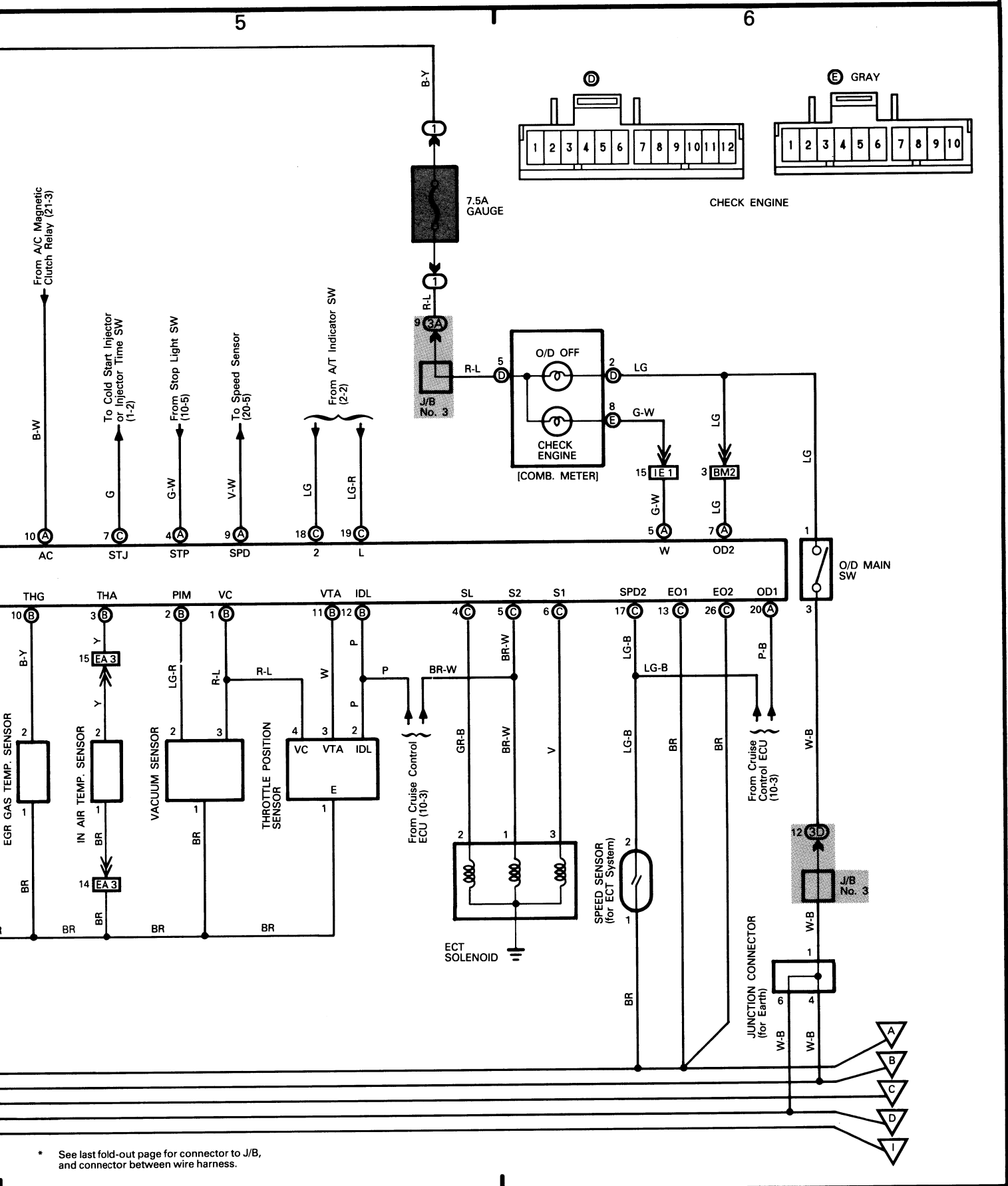

* See last fold-out page for connector to J/B, and connector between wire harness.

MR2 (Cont'd)



Power Source

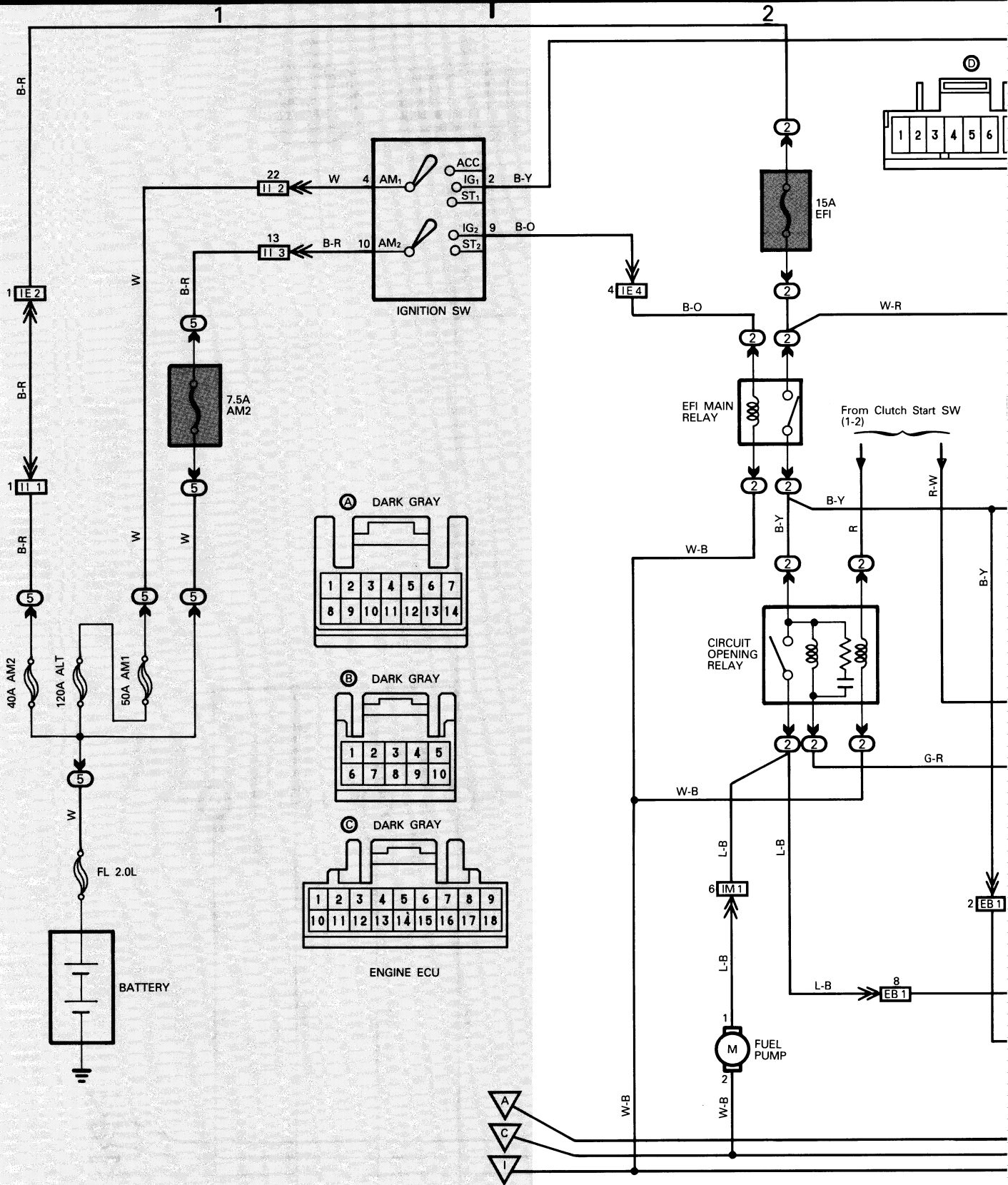

Ground points

△ A = Located on intake manifold

△ C = Located on intake manifold



Engine Control (5S-FE M/T)

3

4

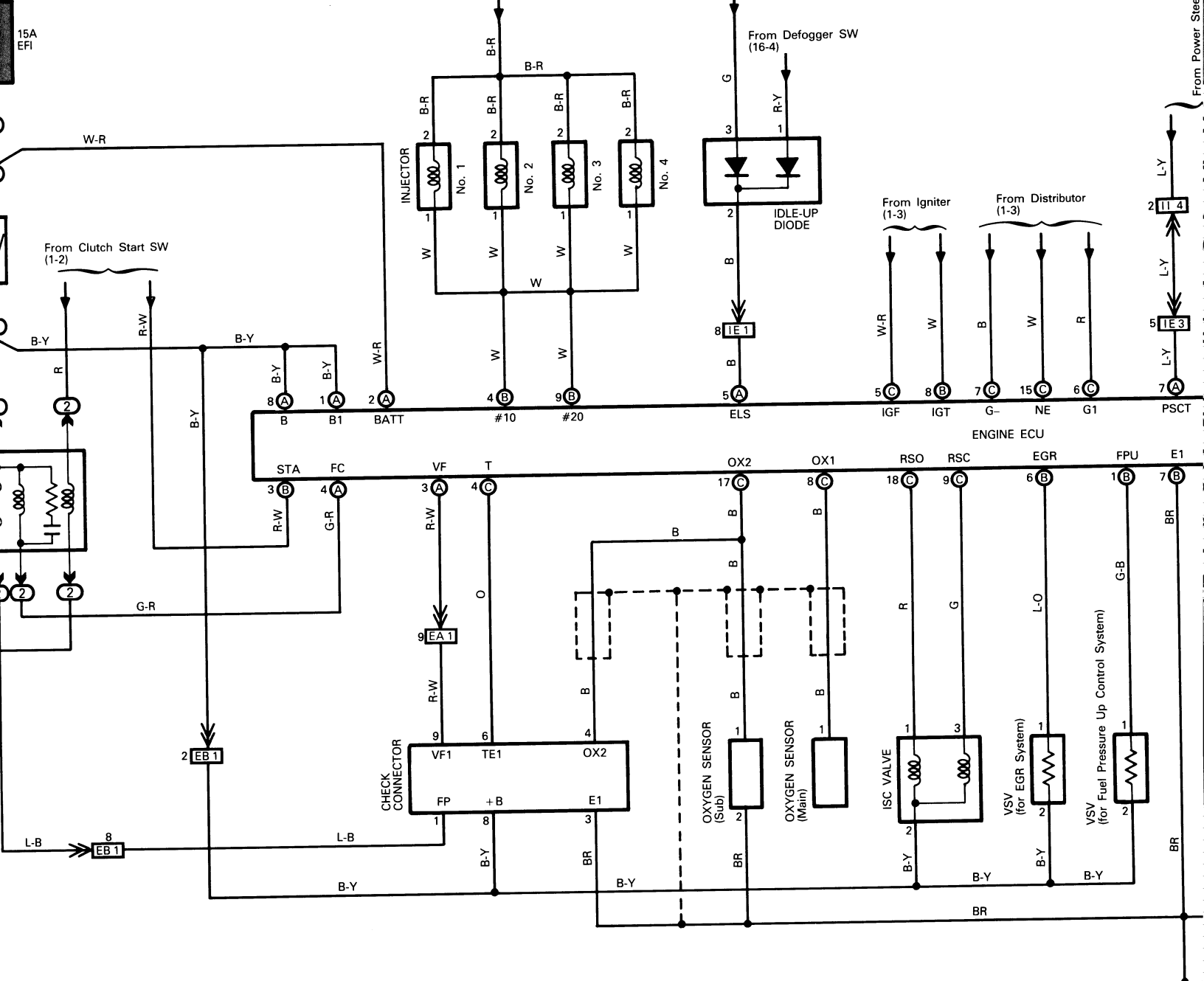
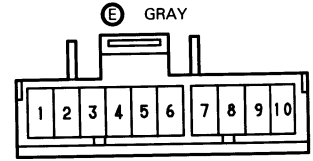
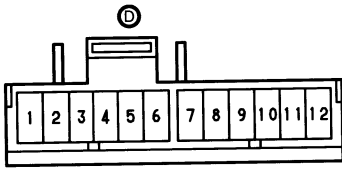

* See last fold-out page for connector to J/B, and connector between wire harness.

control (5S-FE M/T)

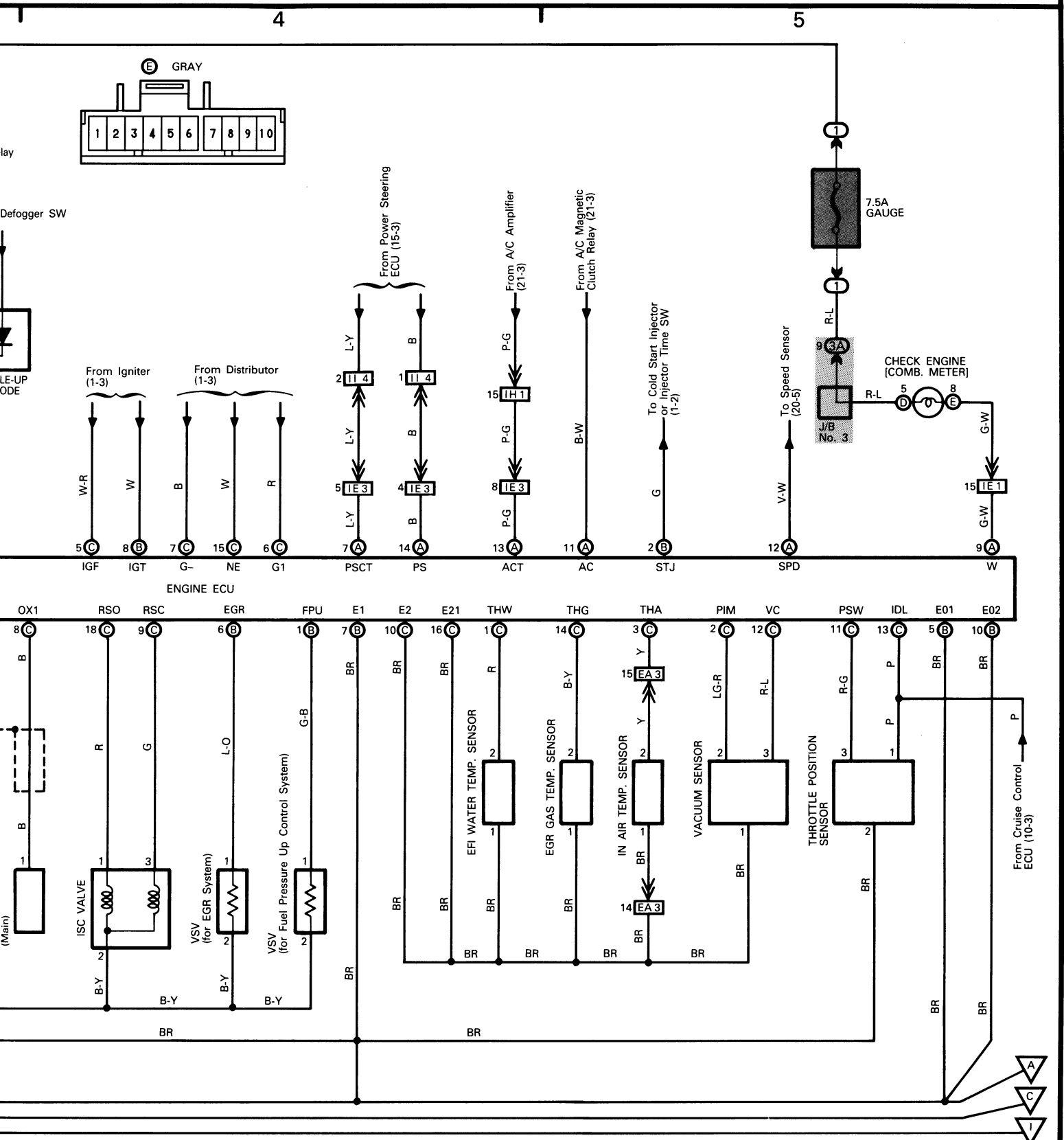

See last fold-out page for connector to J/B, and connector between wire harness.

6 MR2 (Cont'd)



Power Source

- w/ Auto Antenna
- △ w/o Auto Antenna

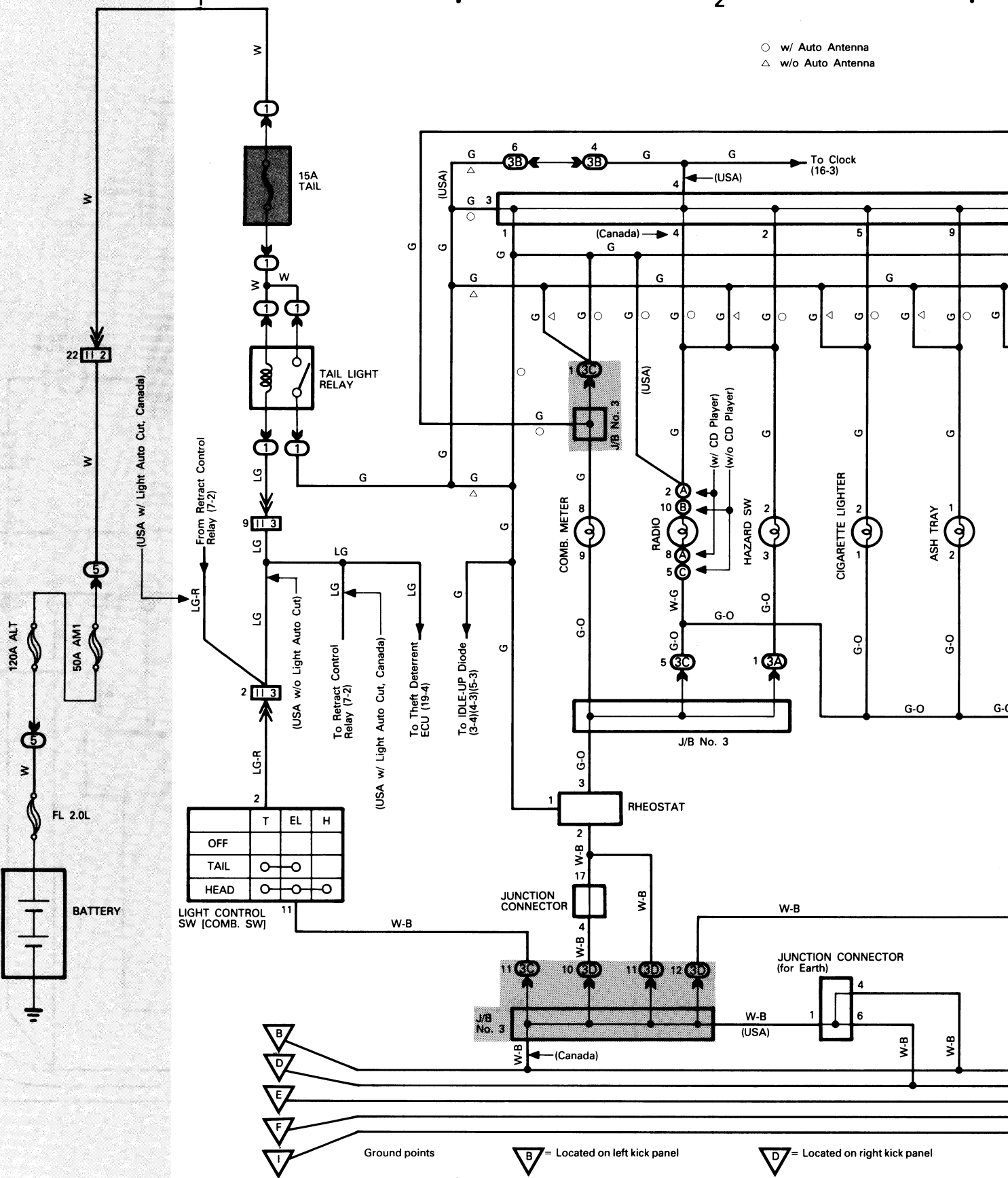

	T	EL	H
OFF			
TAIL	○	○	
HEAD	○	○	○

LIGHT CONTROL SW (COMB. SW)

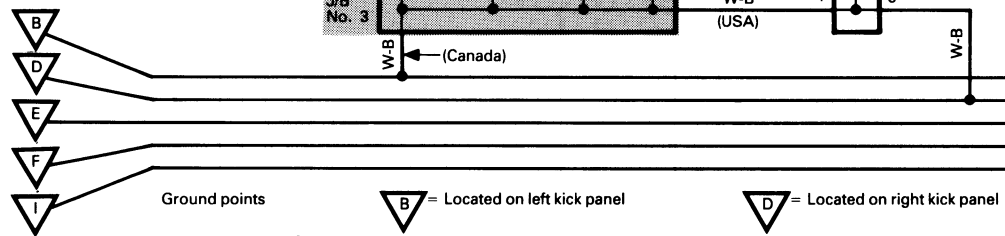
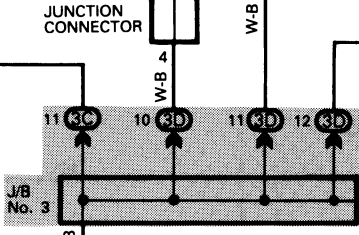



Taillights and Illumination

2

3

4

- w/ Auto Antenna
- △ w/o Auto Antenna

1	2	3
7	8	9

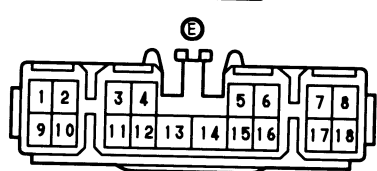
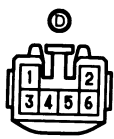
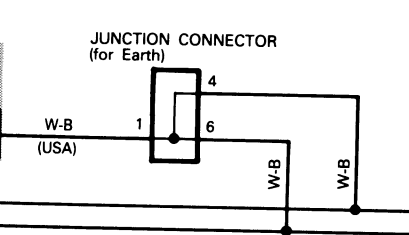
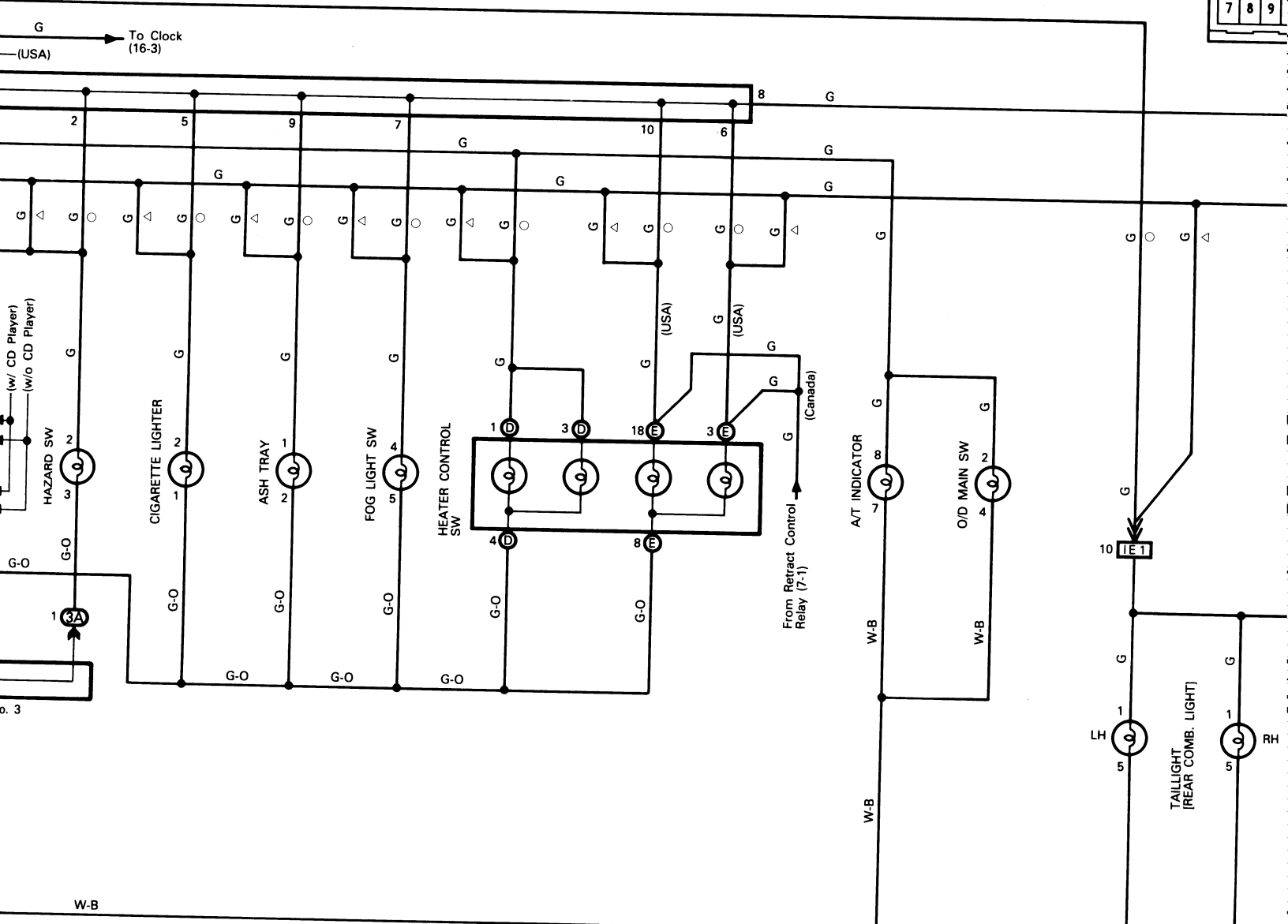

HEATER CONTROL SW

▷ = Located on right kick panel

▽ = Located on front right fender

▽ = Located on front left fender

▽ = Located on back panel center

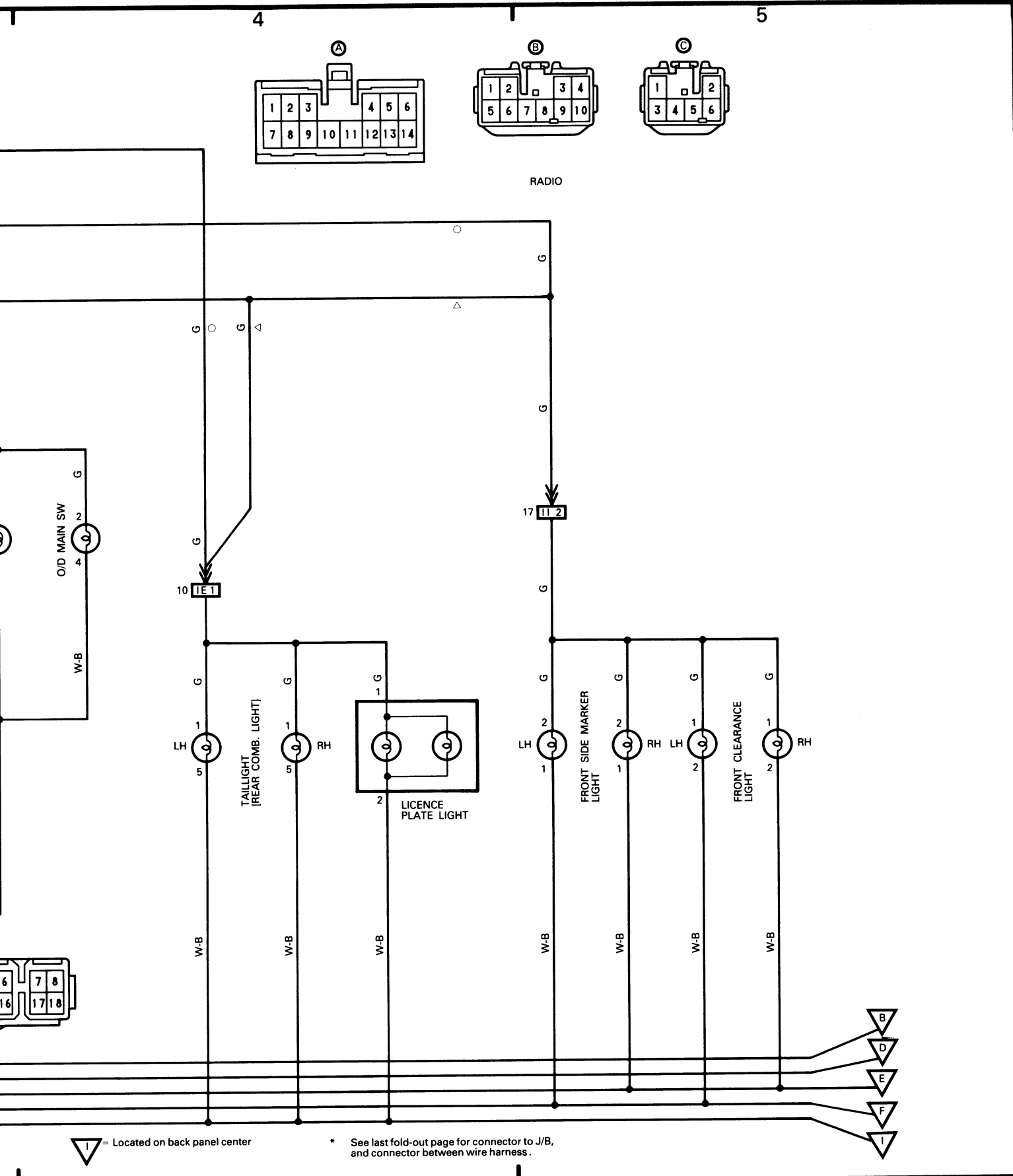

▽ = Located on back panel center

* See last fold-out page for connector to J/B, and connector between wire harness.



MR2 (Cont'd)



Power Source

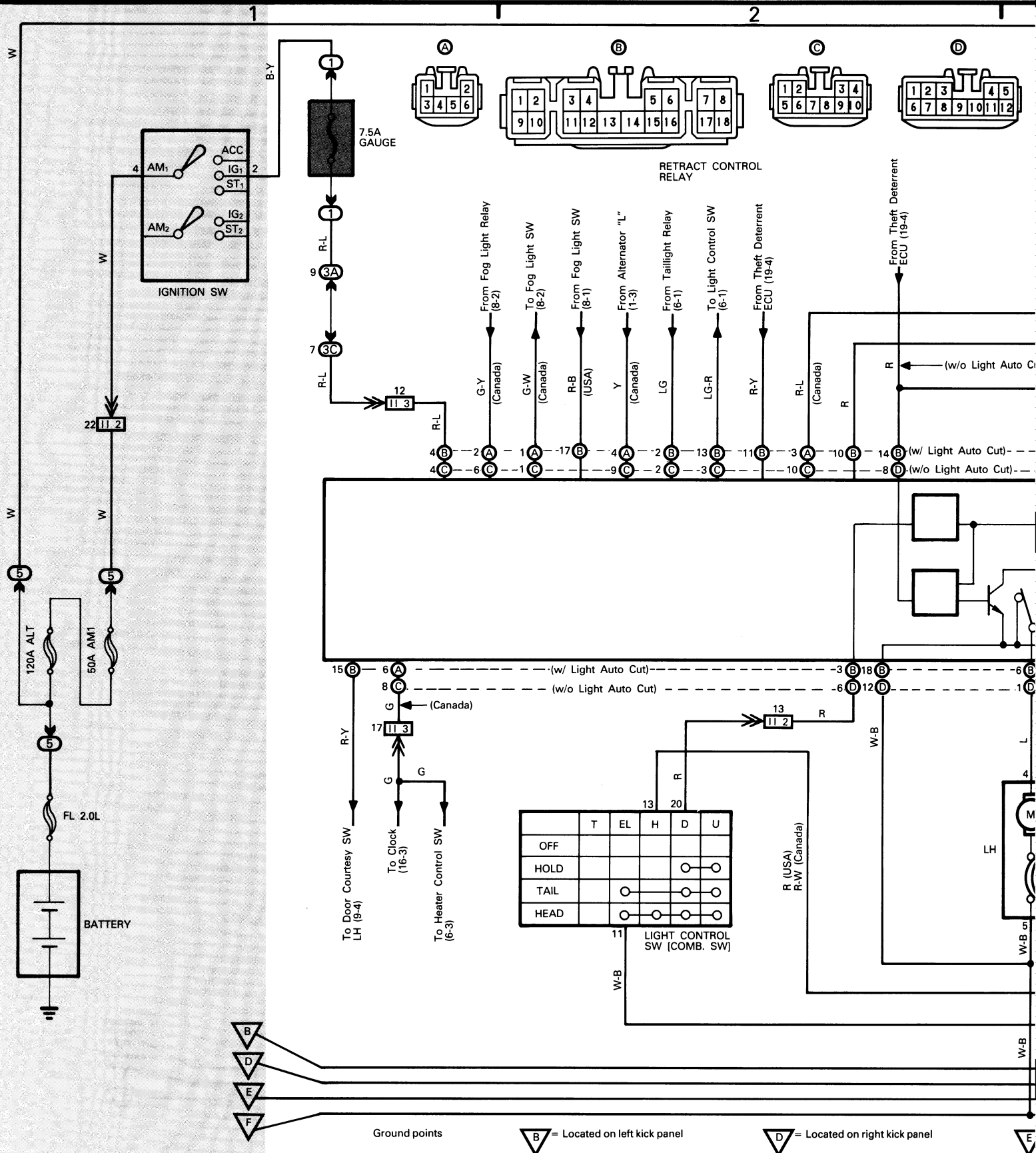

	T	EL	H	D	U
OFF					
HOLD				○	○
TAIL		○		○	
HEAD		○	○	○	○

11 W-B
13 R
20 R

R (USA)
R-W (Canada)

Ground points ▽ B = Located on left kick panel ▽ D = Located on right kick panel



Headlight

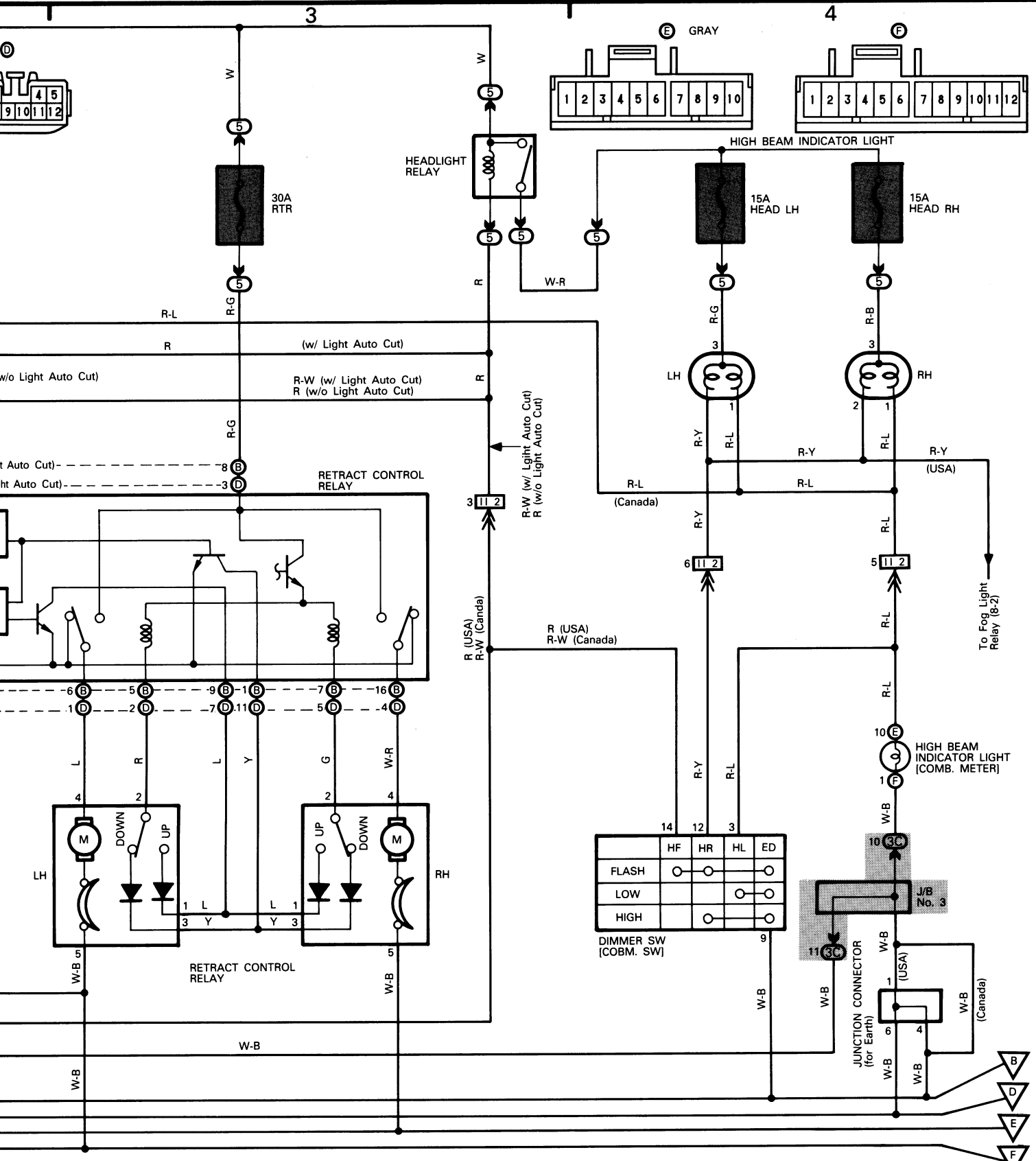

E = Located on front right fender

F = Located on front left fender

* See last fold-out page for connector to J/B, and connector between wire harness.

8 MR2 (Cont'd)

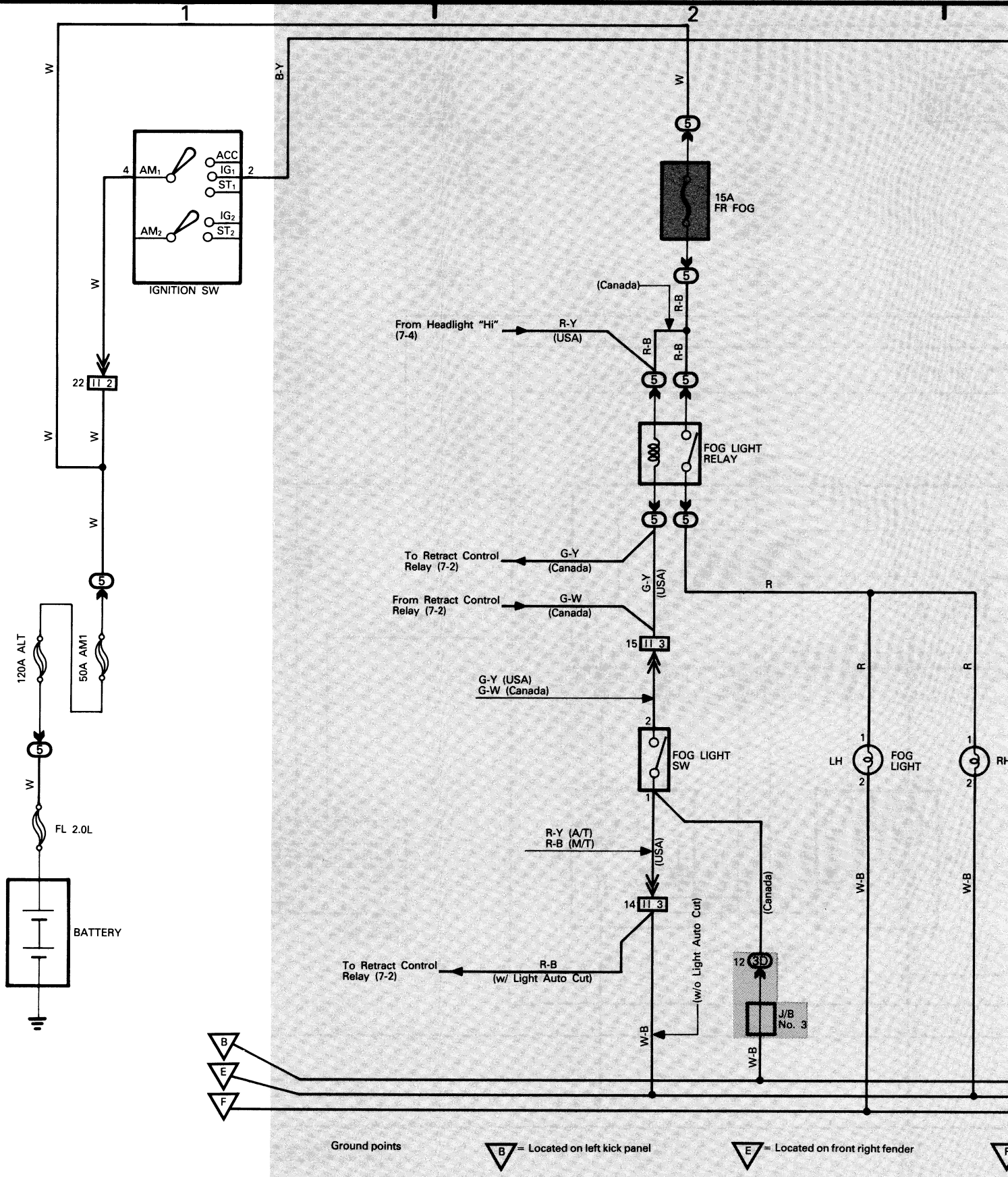

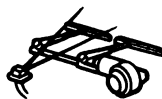

Front Wiper and Washer

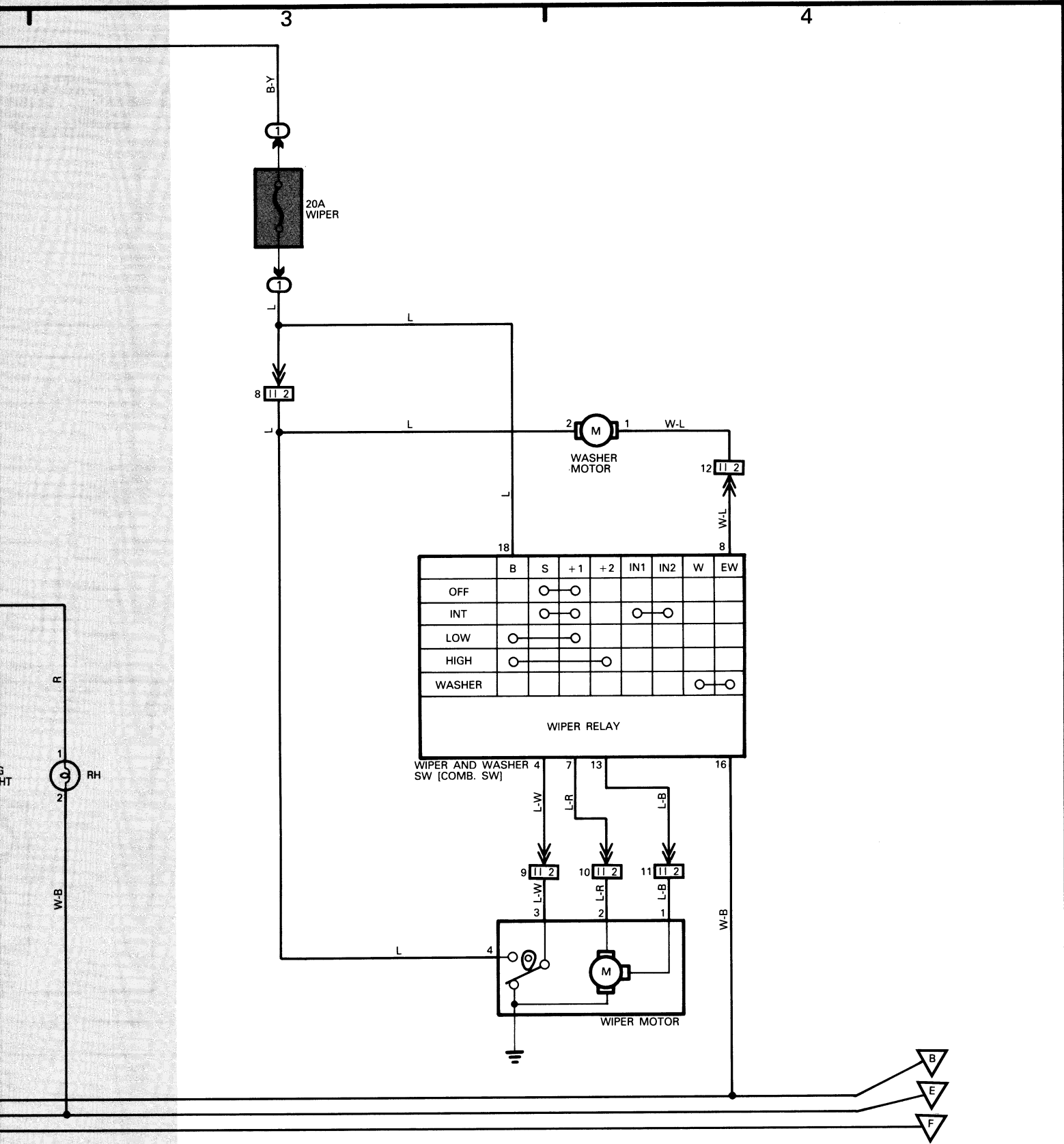

F = Located on front left fender

* See last fold-out page for connector to J/B, and connector between wire harness.

MR2 (Con'd)



Power Source

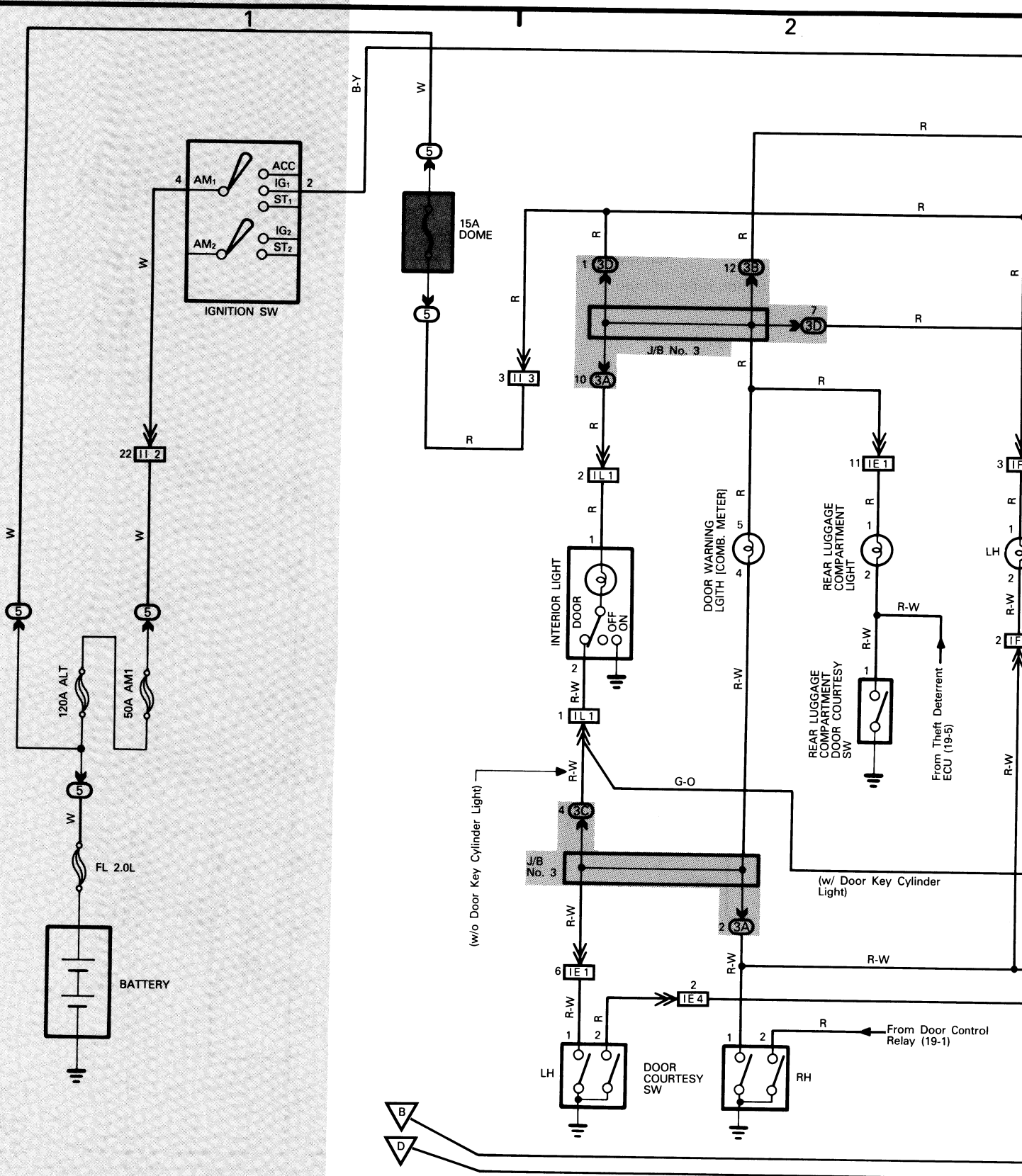
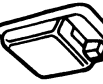

Ground points

= Located on left kick panel

= Located on right kick panel

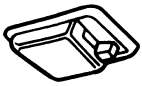

Interior Light

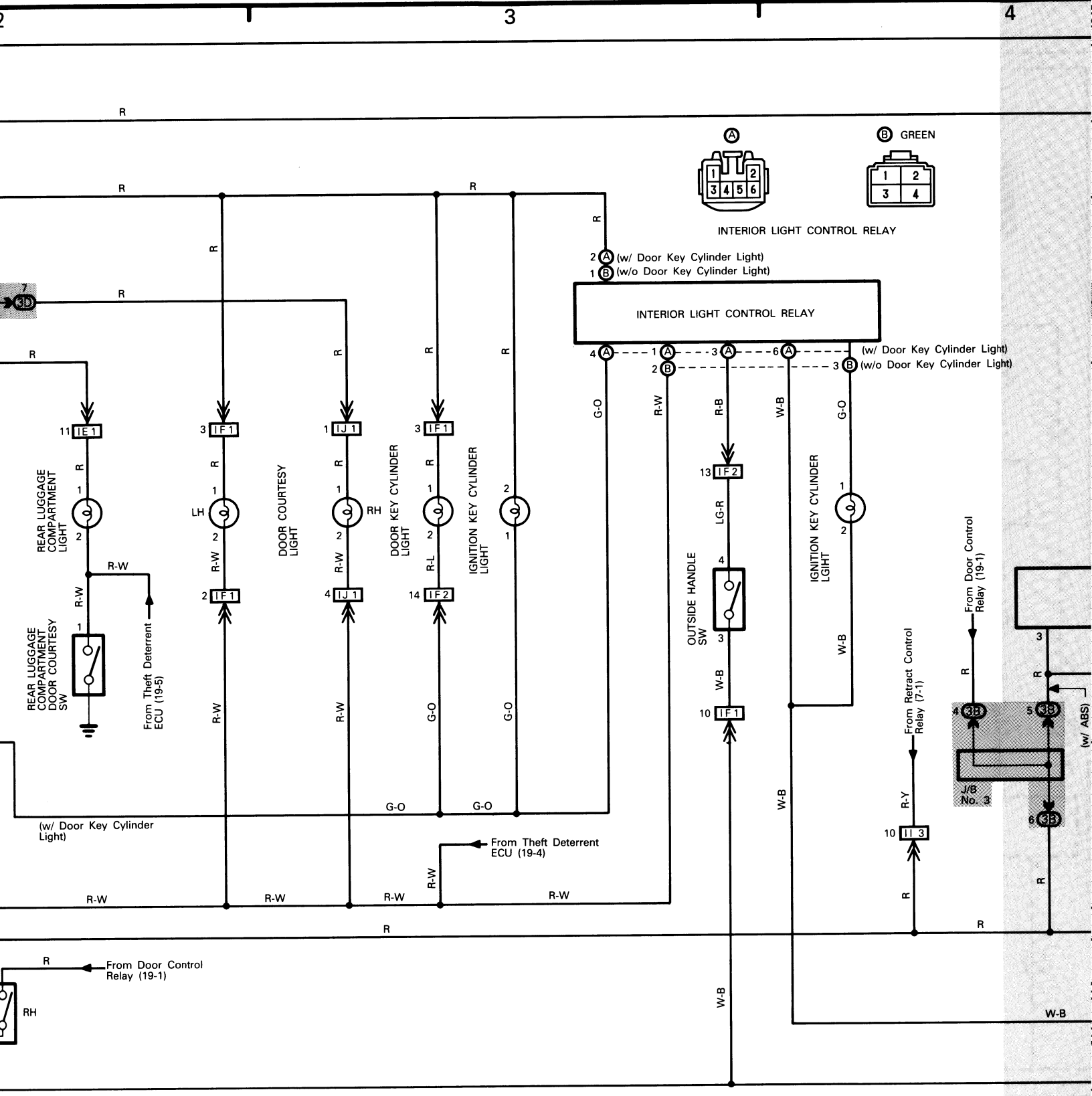

INTERIOR LIGHT CONTROL RELAY

2 (A) (w/ Door Key Cylinder Light)
 1 (B) (w/o Door Key Cylinder Light)

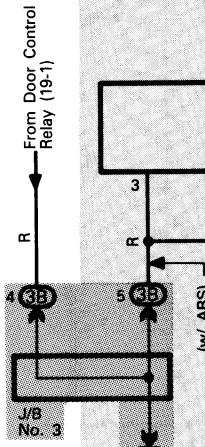

= Located on right kick panel

* See last fold-out page for connector to J/B, and connector between wire harness.



Unlock and Seat Belt Warning

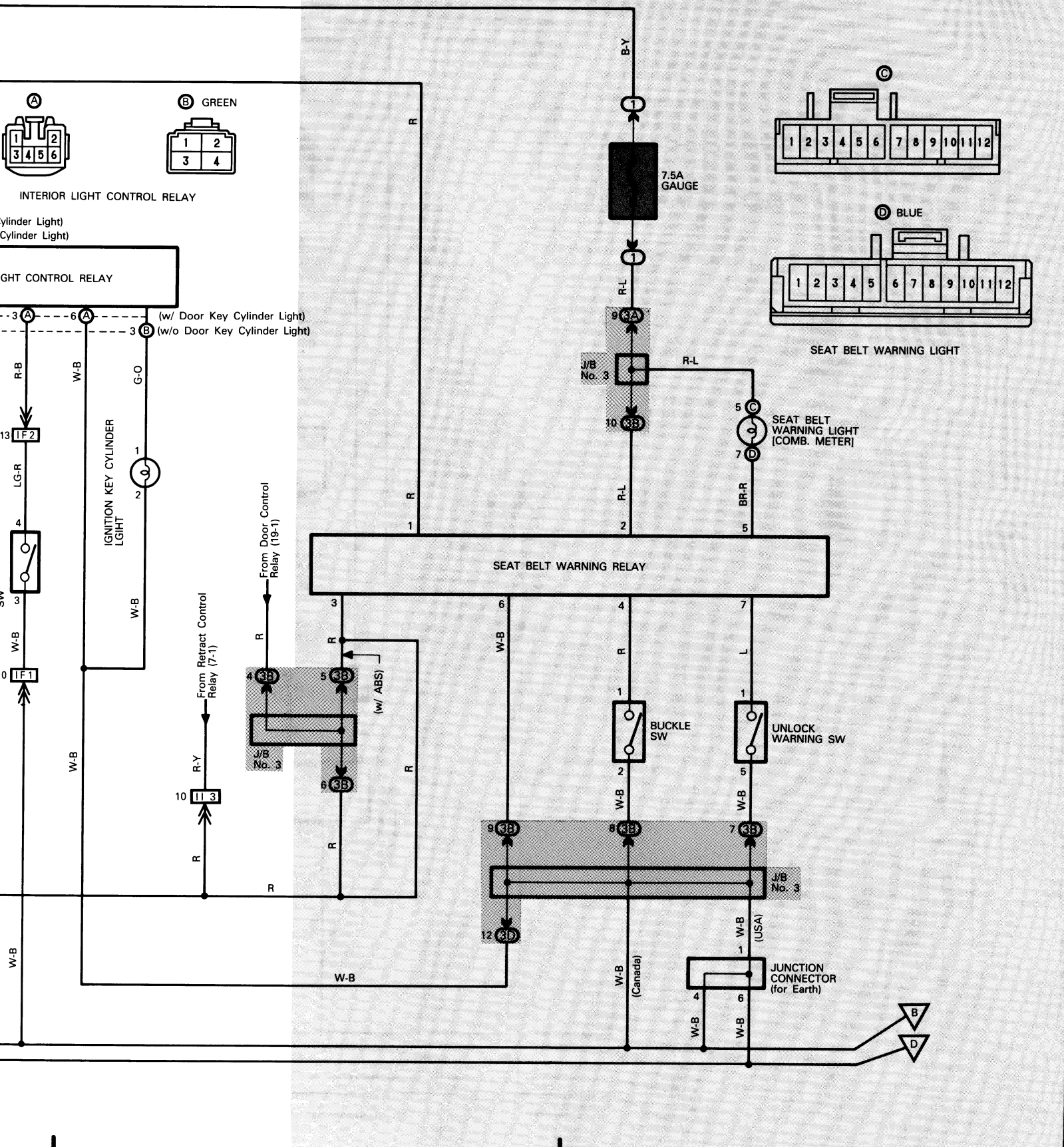

10 MR2 (Cont'd)



Power Source

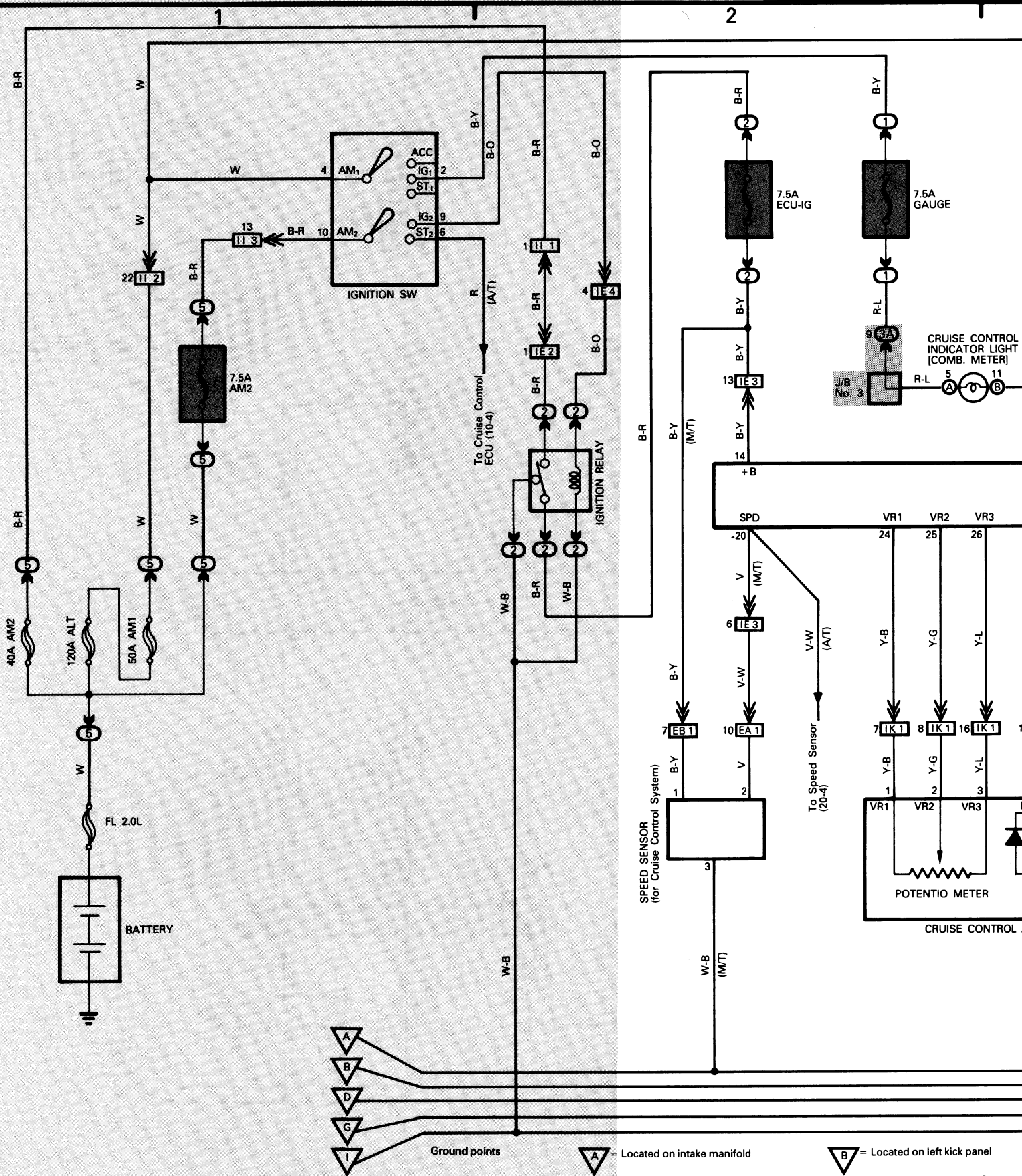



Cruise Control

3

4

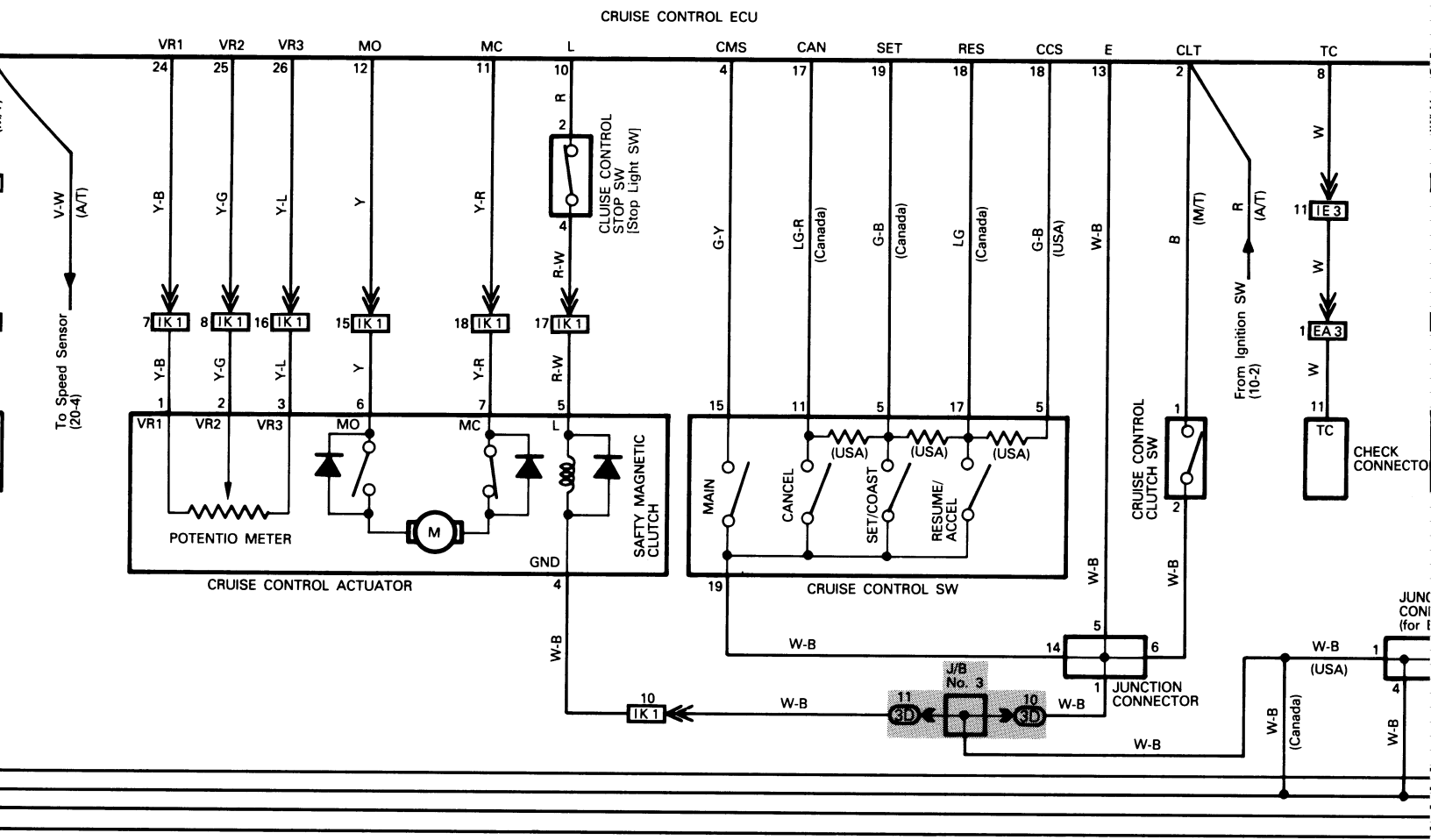
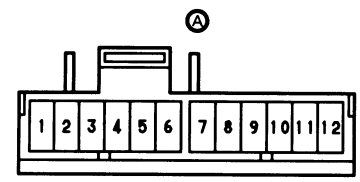
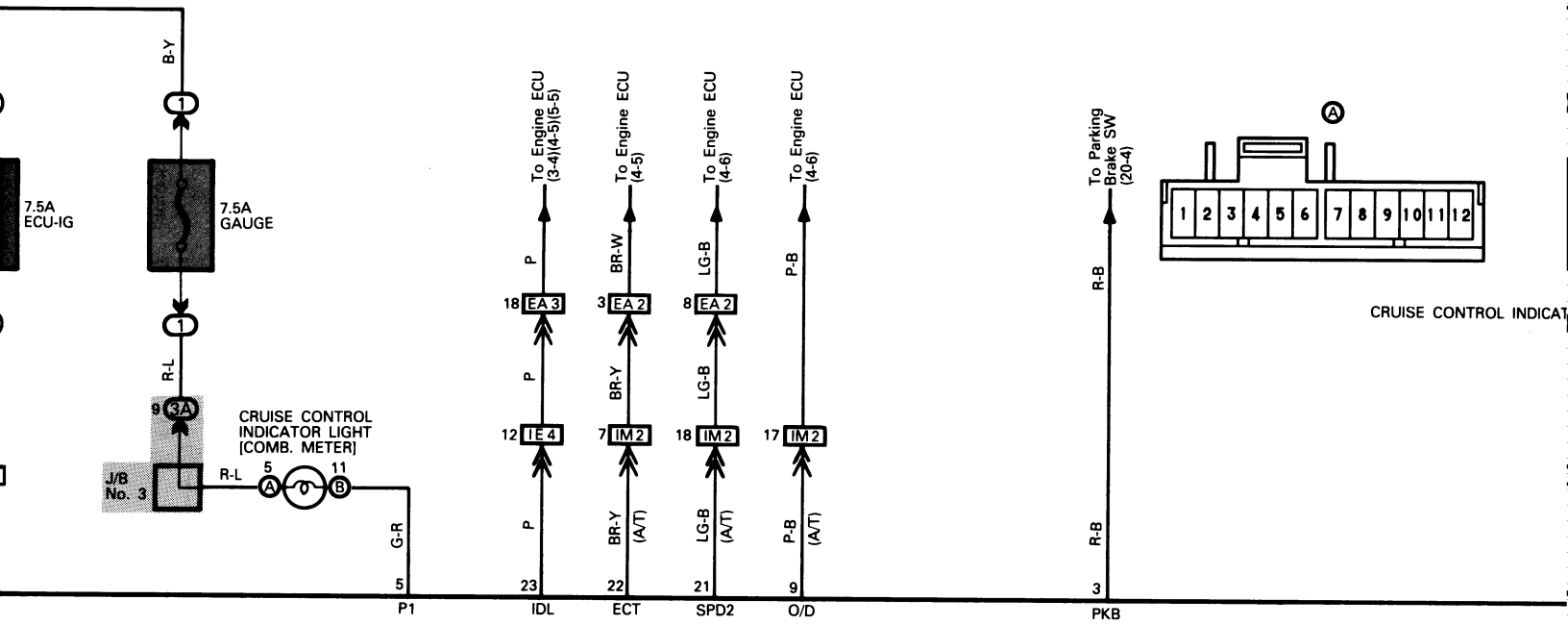

- = Located on left kick panel
- = Located on right kick panel
- = Located under the left center pillar
- = Located on back panel center

MR2 (Cont'd)

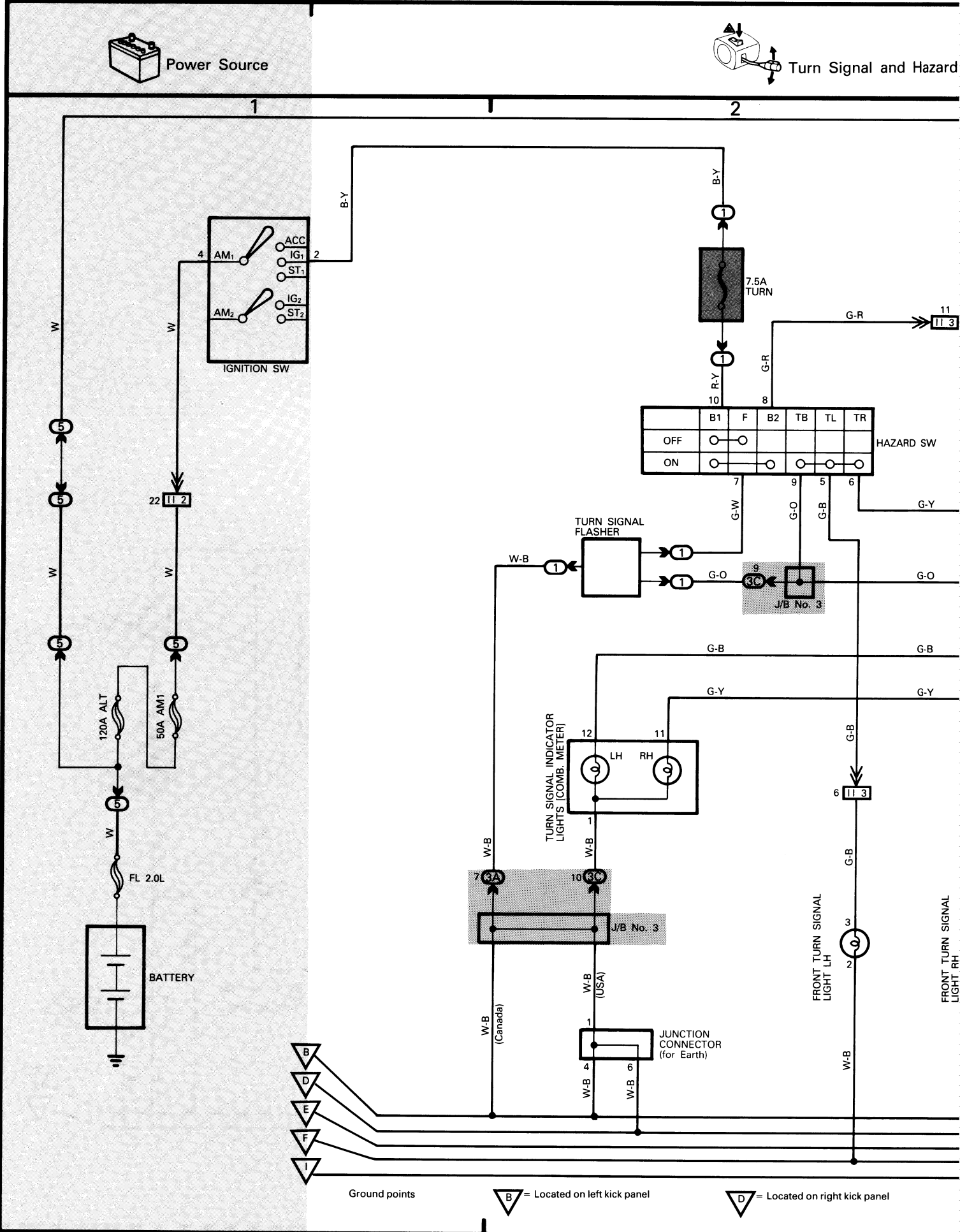

azard



Horn

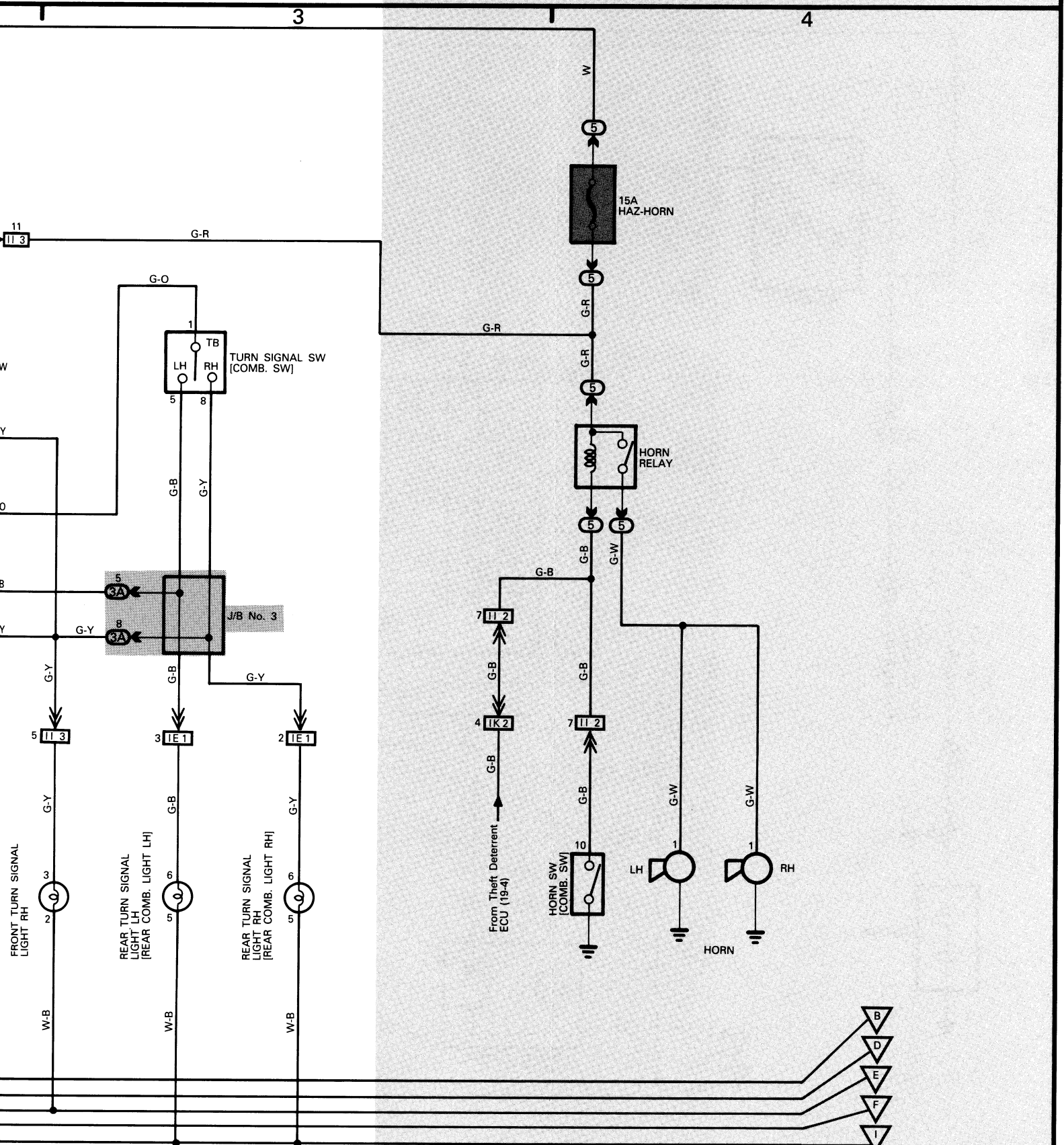

E = Located on front right fender

F = Located on front left fender

I = Located on back panel center

* See last fold-out page for connector to J/B, and connector between wire harness.

12 MR2 (Caont'd)



Power Source

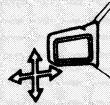

Remote Control Mirror

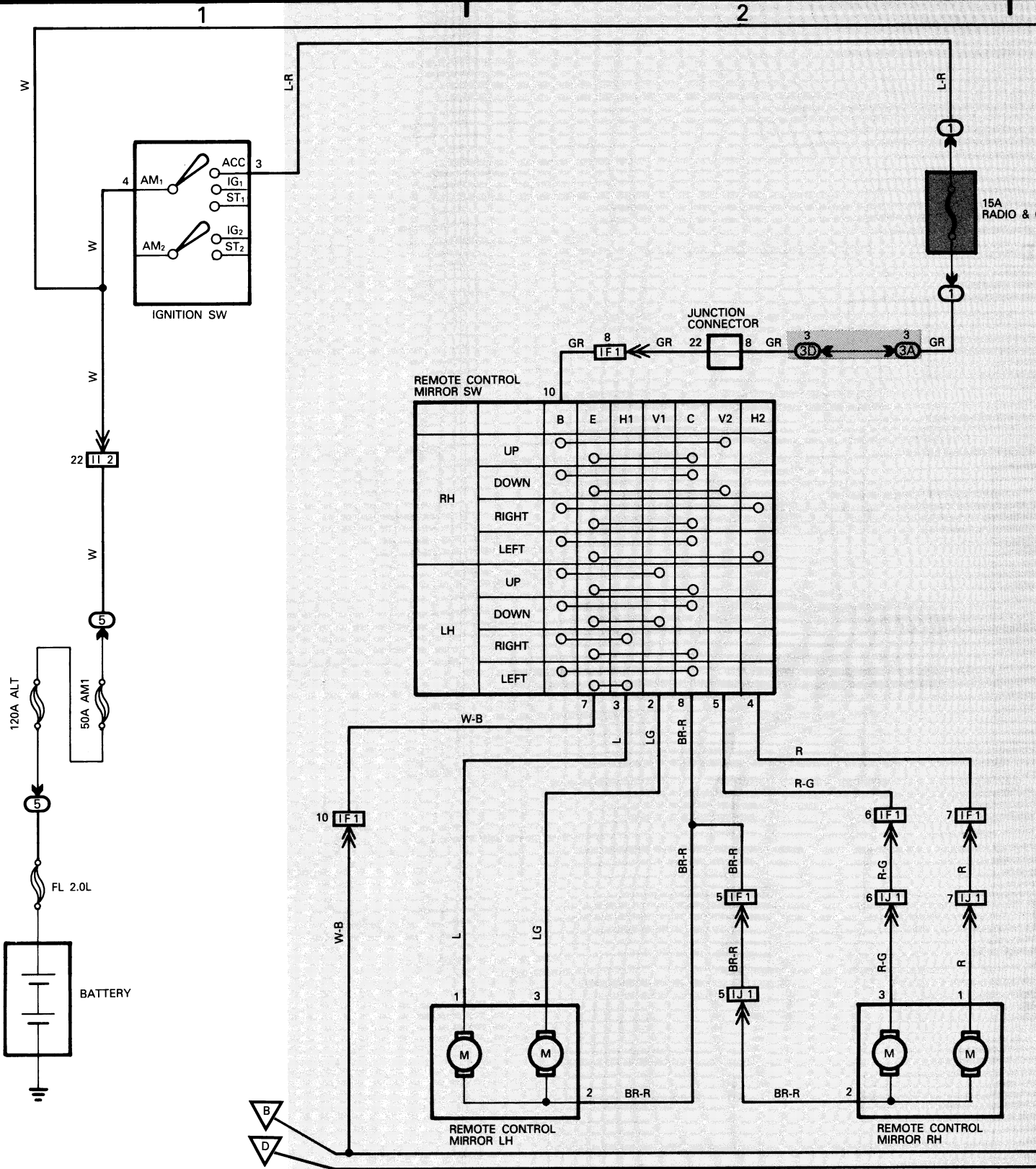

Ground points

B = Located on left kick panel

D = Located on right kick panel

* See last fold and connect

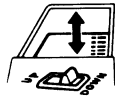

Power Window

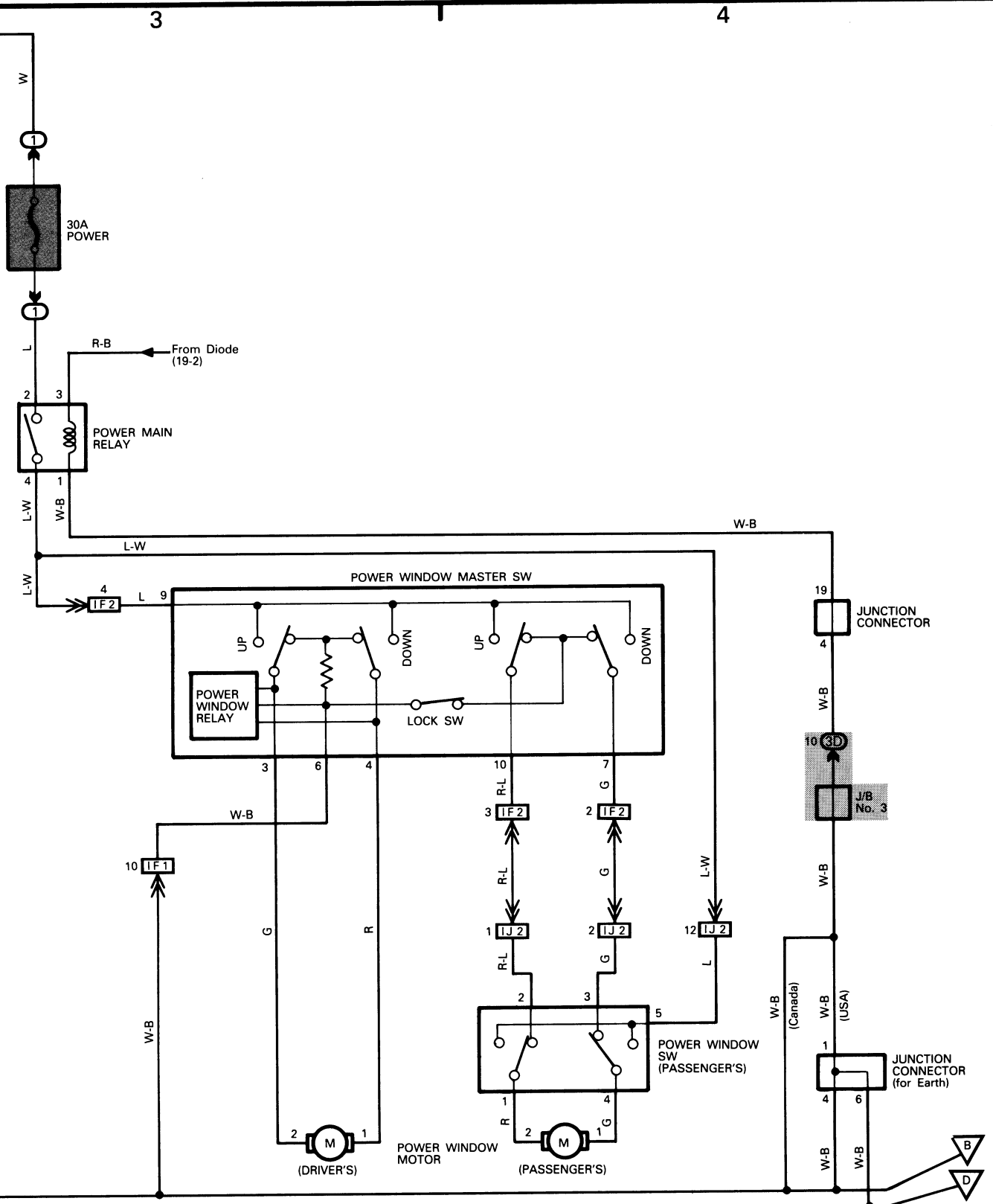

last fold-out page for connector to J/B, connector between wire harness.

MR2 (Cont'd)



Power Source

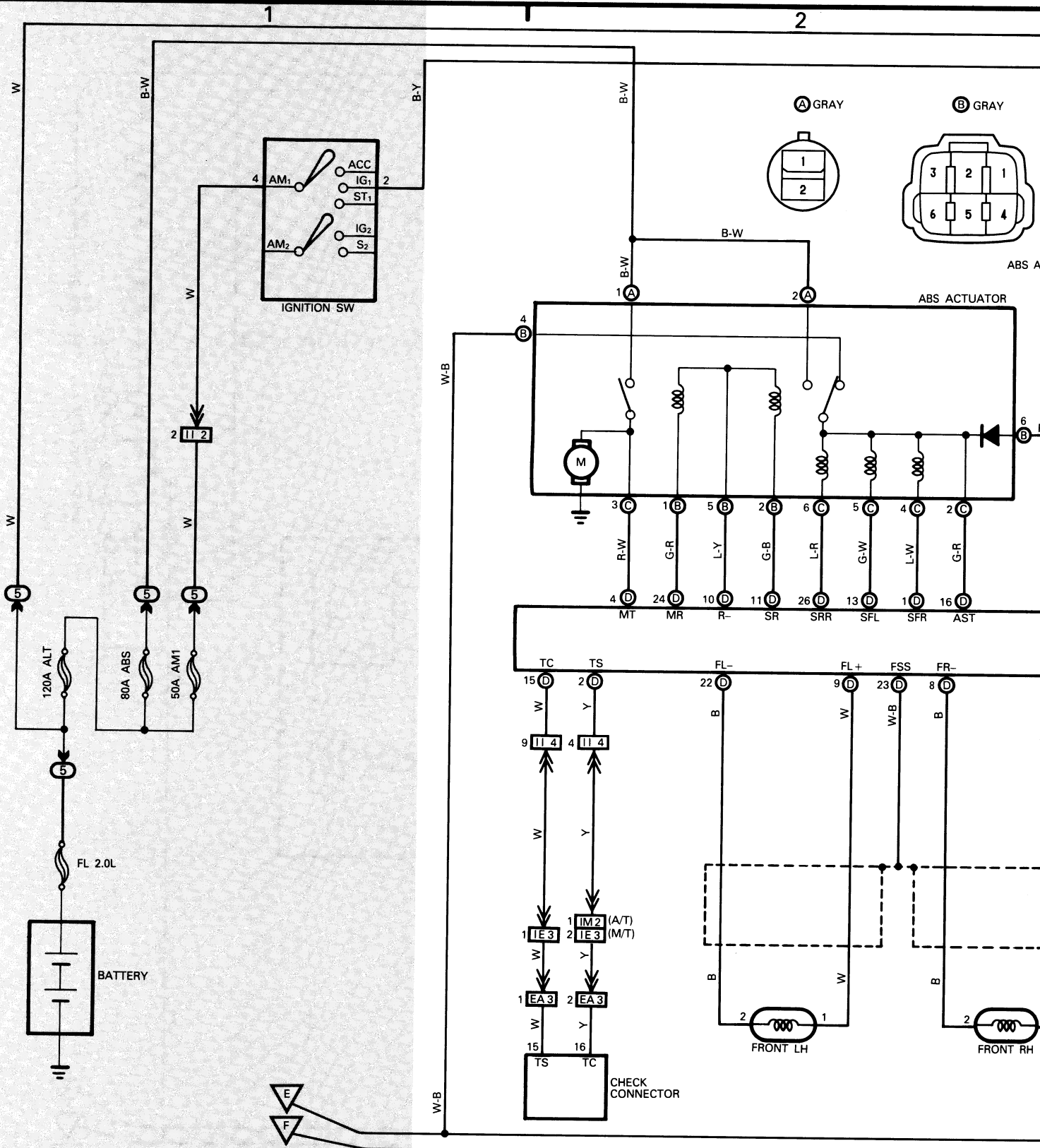

Ground points

= Located on front right fender

= Located on front left fender



ABS (Anti-lock Brake System)

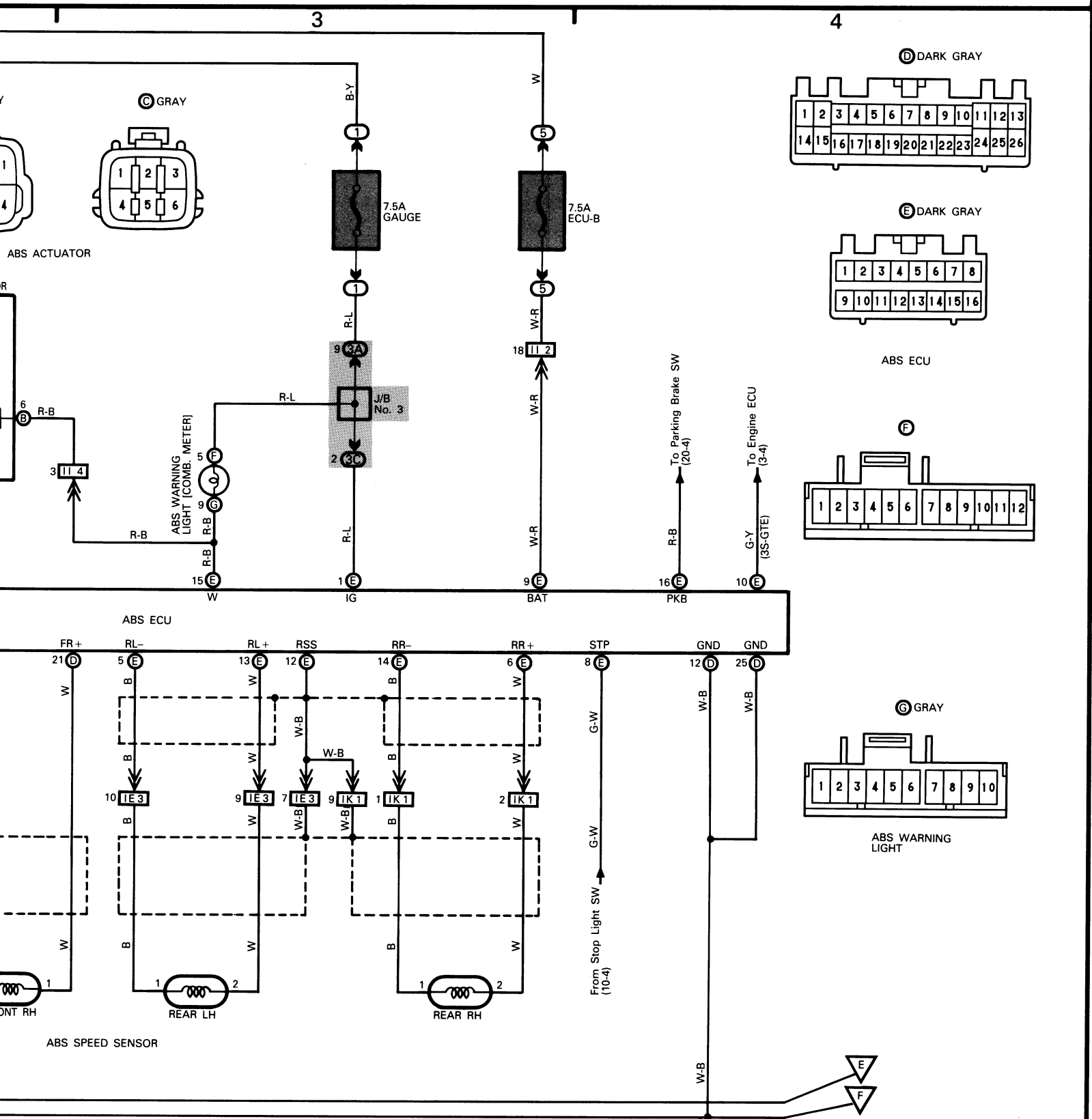

* See last fold-out page for connector to J/B, and connector between wire harness.

14 MR2 (Cont'd)



Power Source

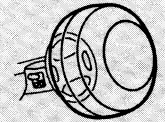

srs Airbag

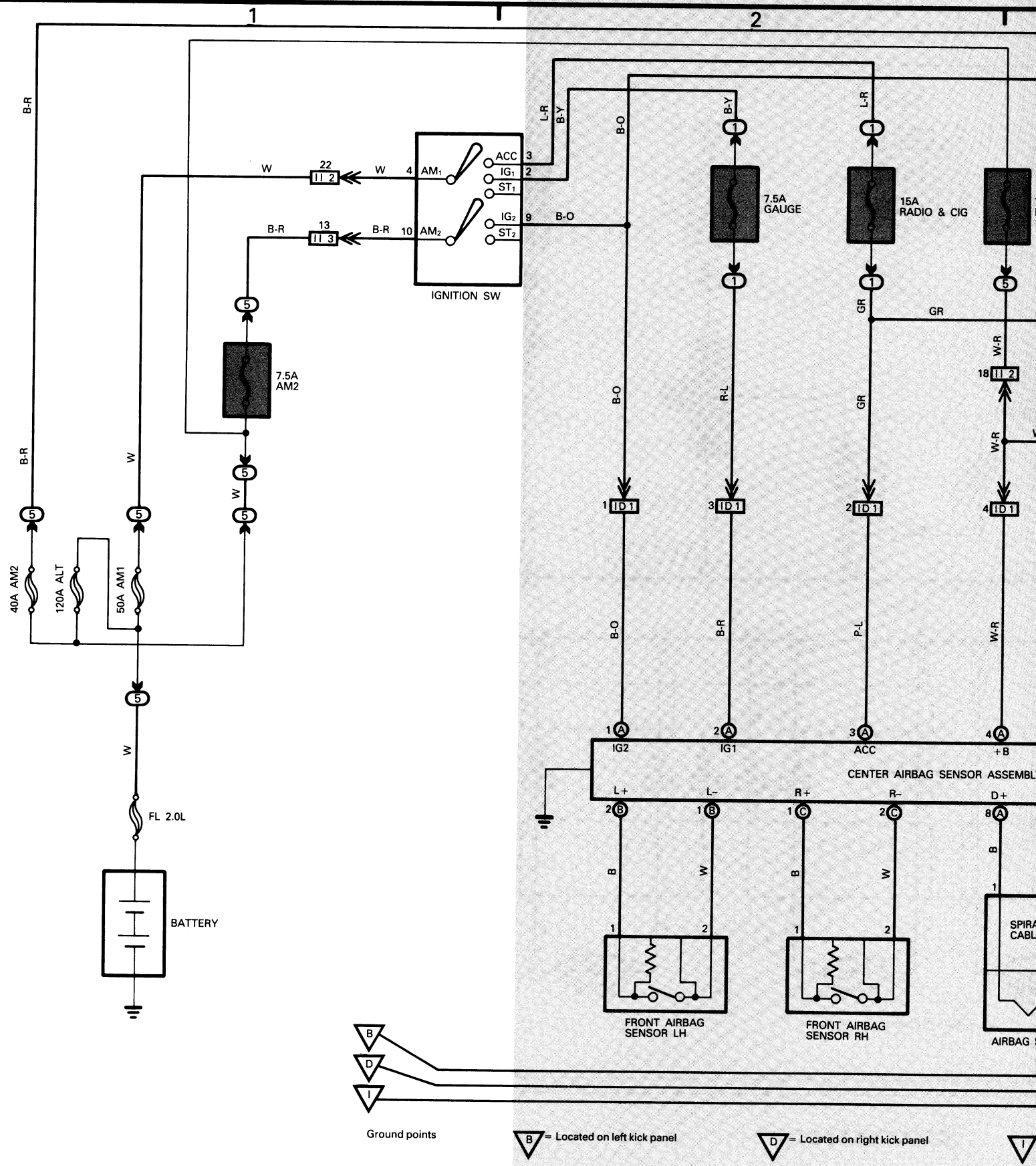



Shift Lock

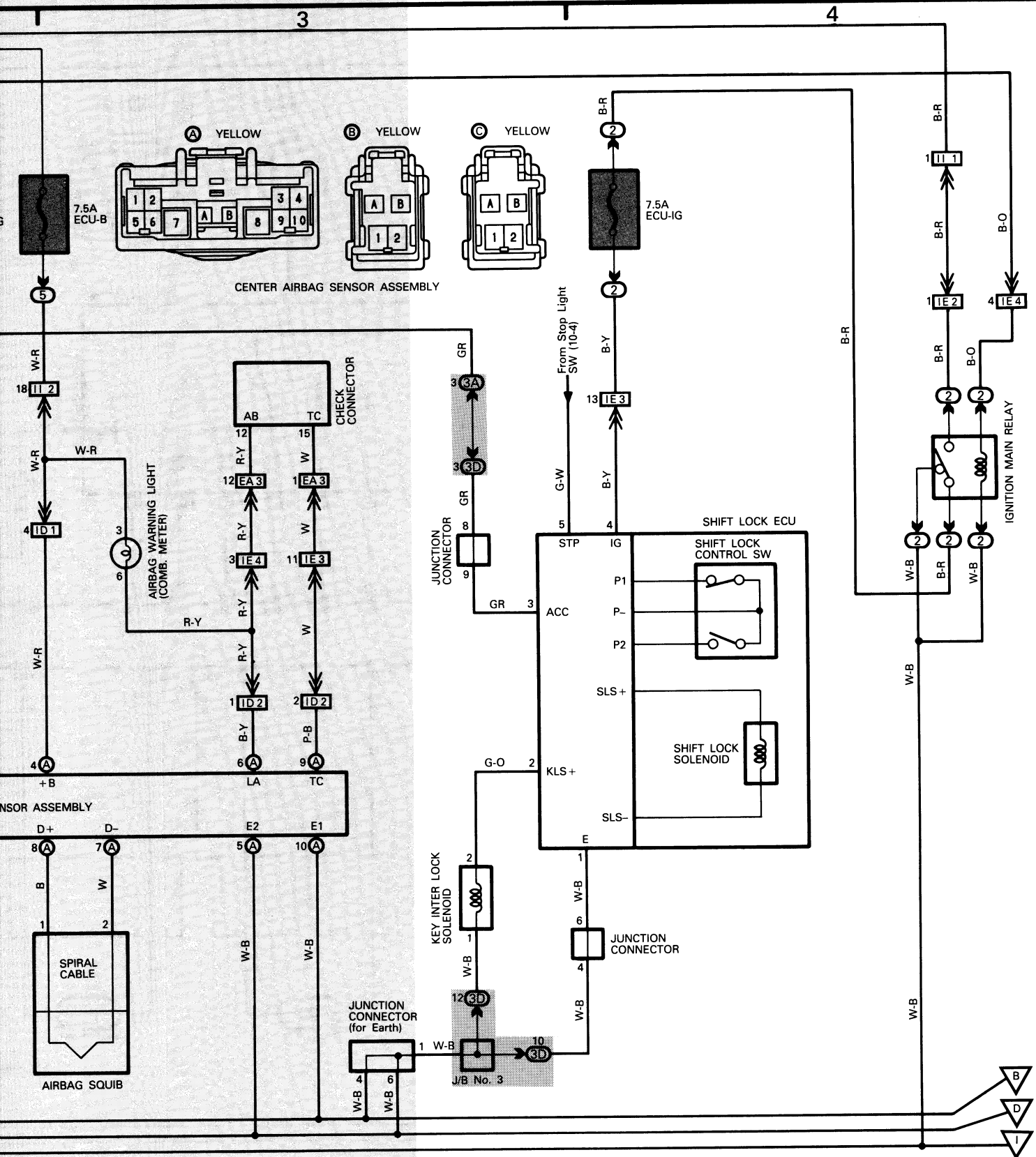

▽ = Located on back panel center

* See last fold-out page for connector to J/B, and connector between wire harness.

MR2 (Cont'd)



Power Source

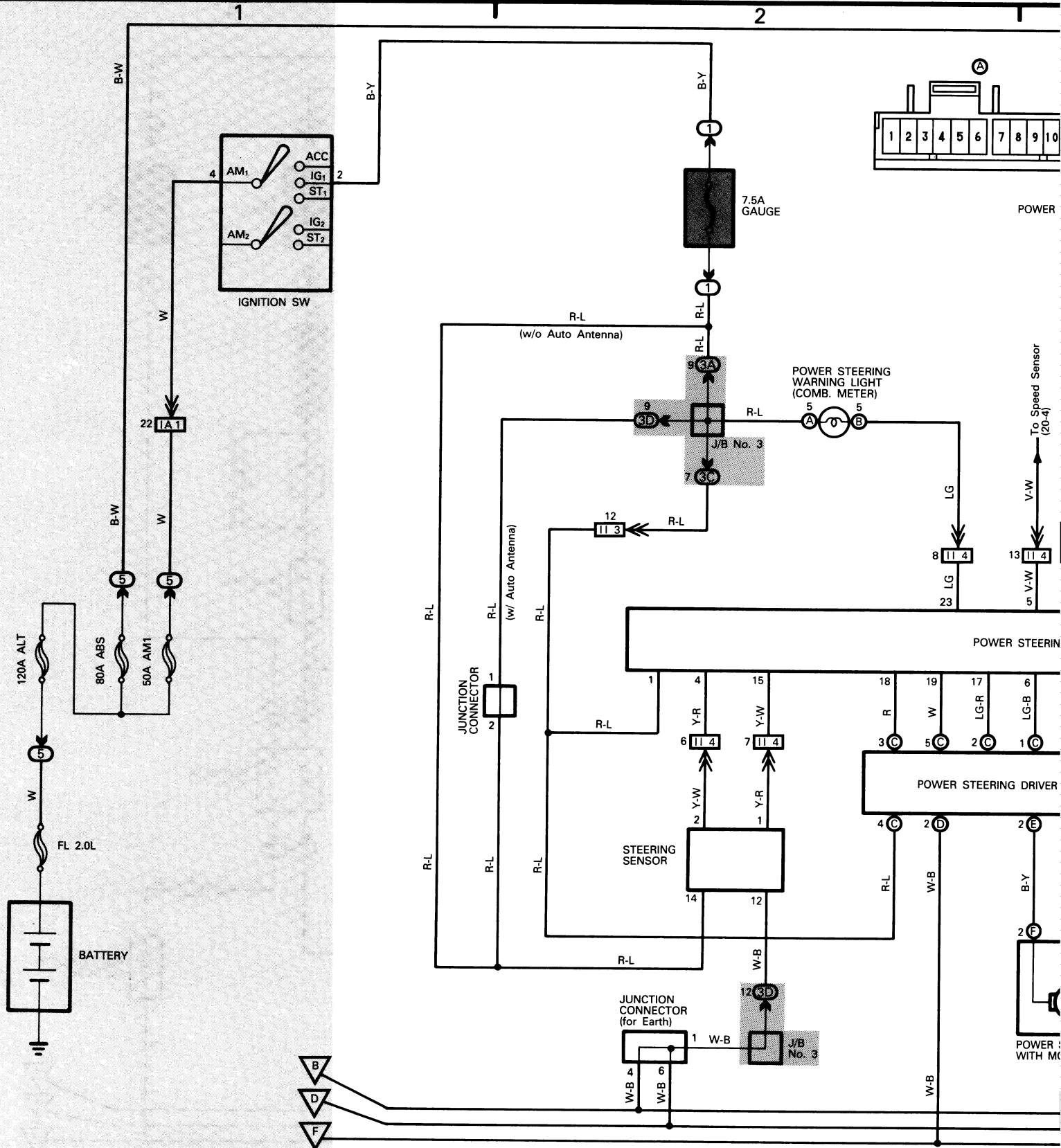

Ground points

B = Located on left kick panel

D = Located on right kick panel

F = Located on right kick panel



Power Steering

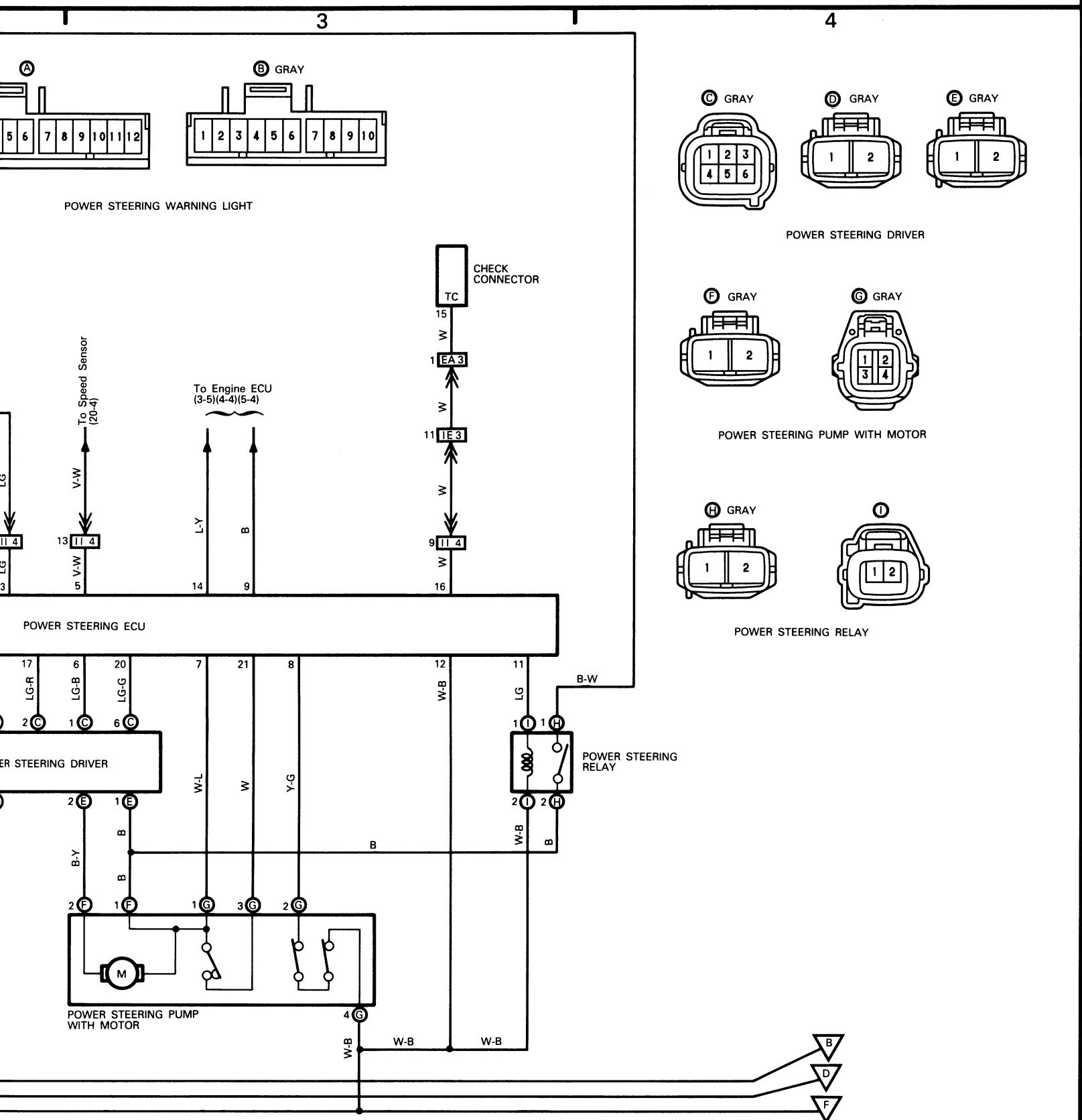

F = Located on front left fender

* See last fold-out page for connector to J/B, and connector between wire harness.

16 MR2 (Cont'd)

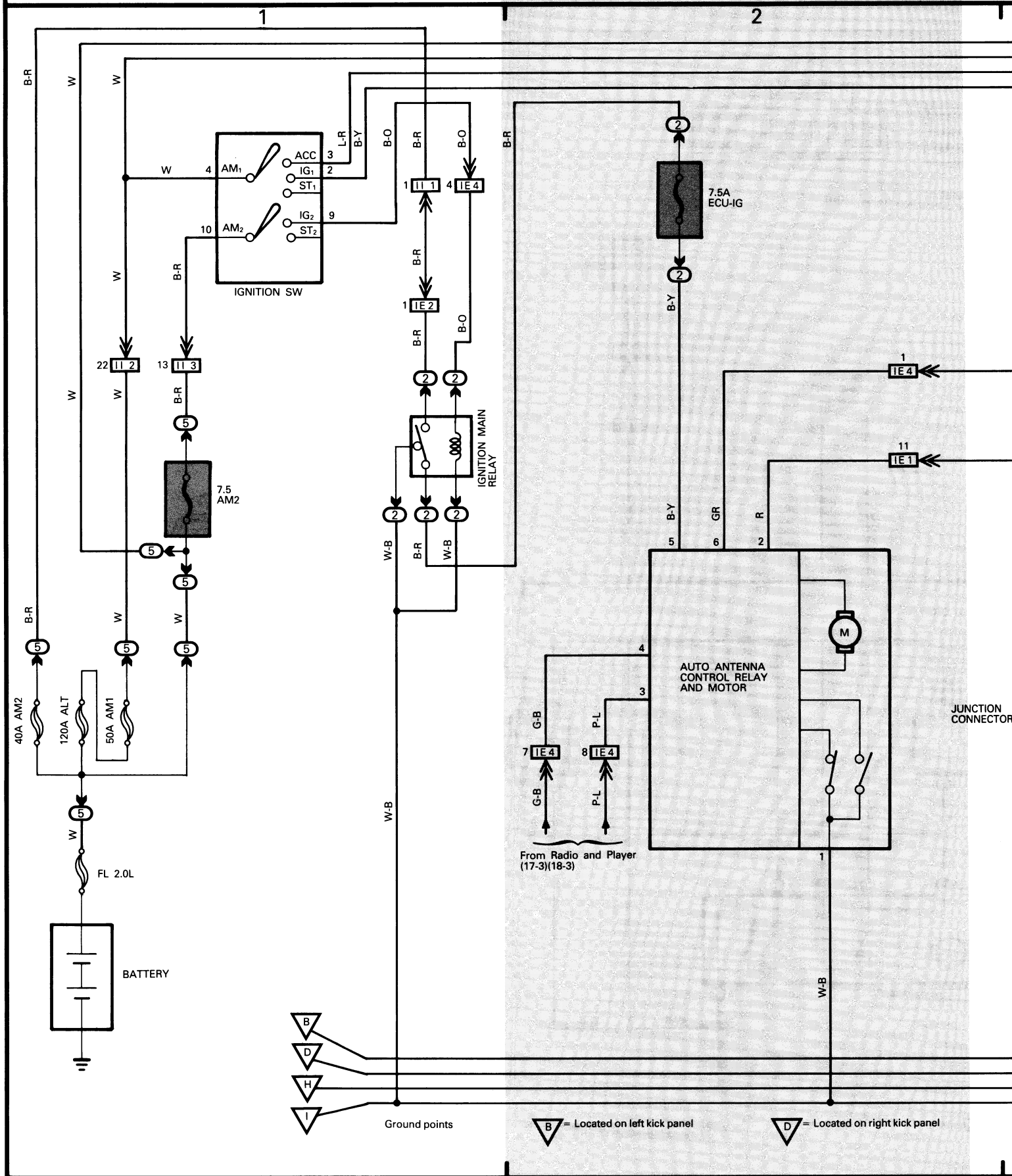
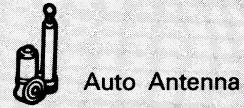



Clock



Cigarette Lighter



Rear Window Defogger

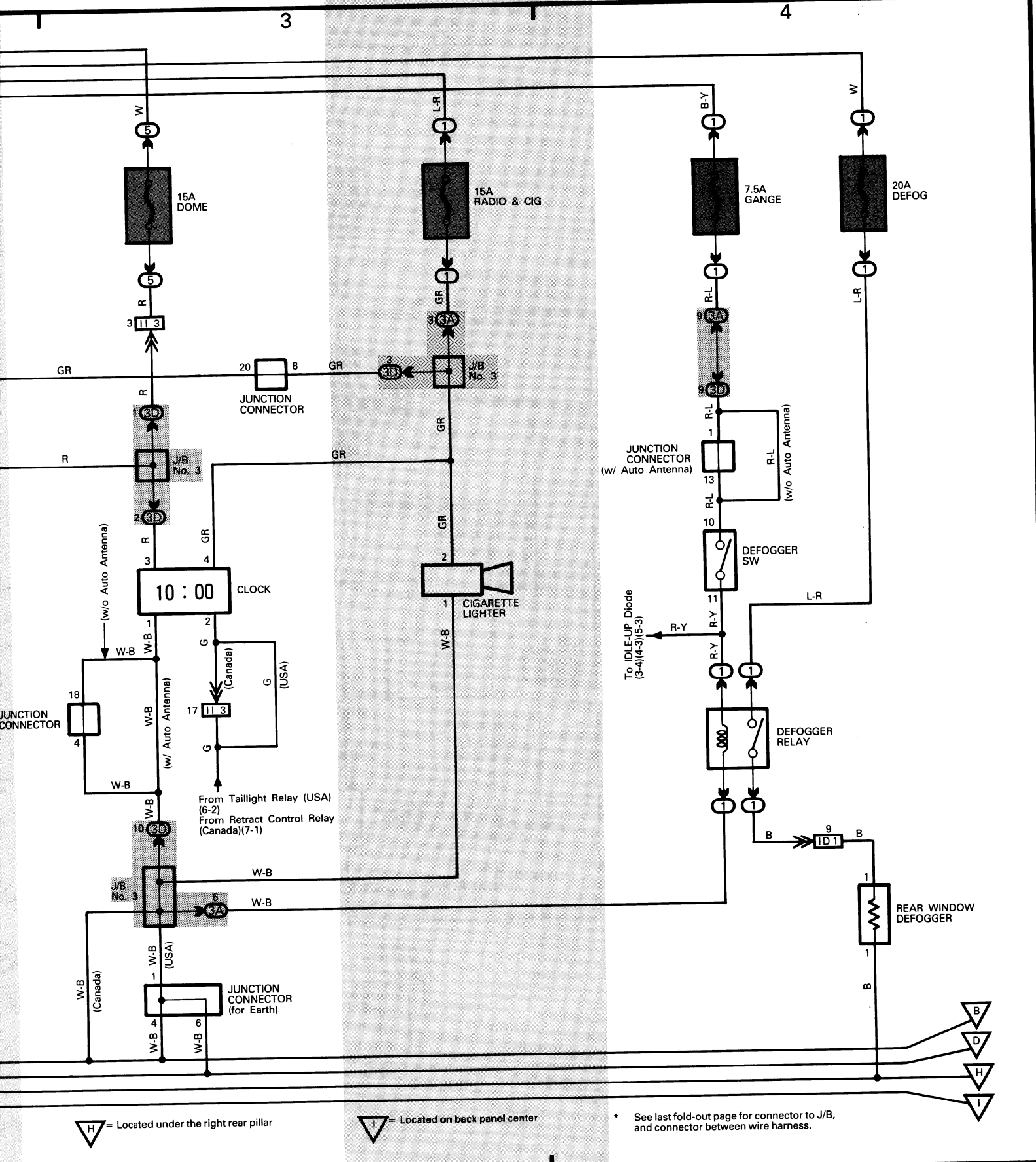

MR2 (Cont'd)



Power Source

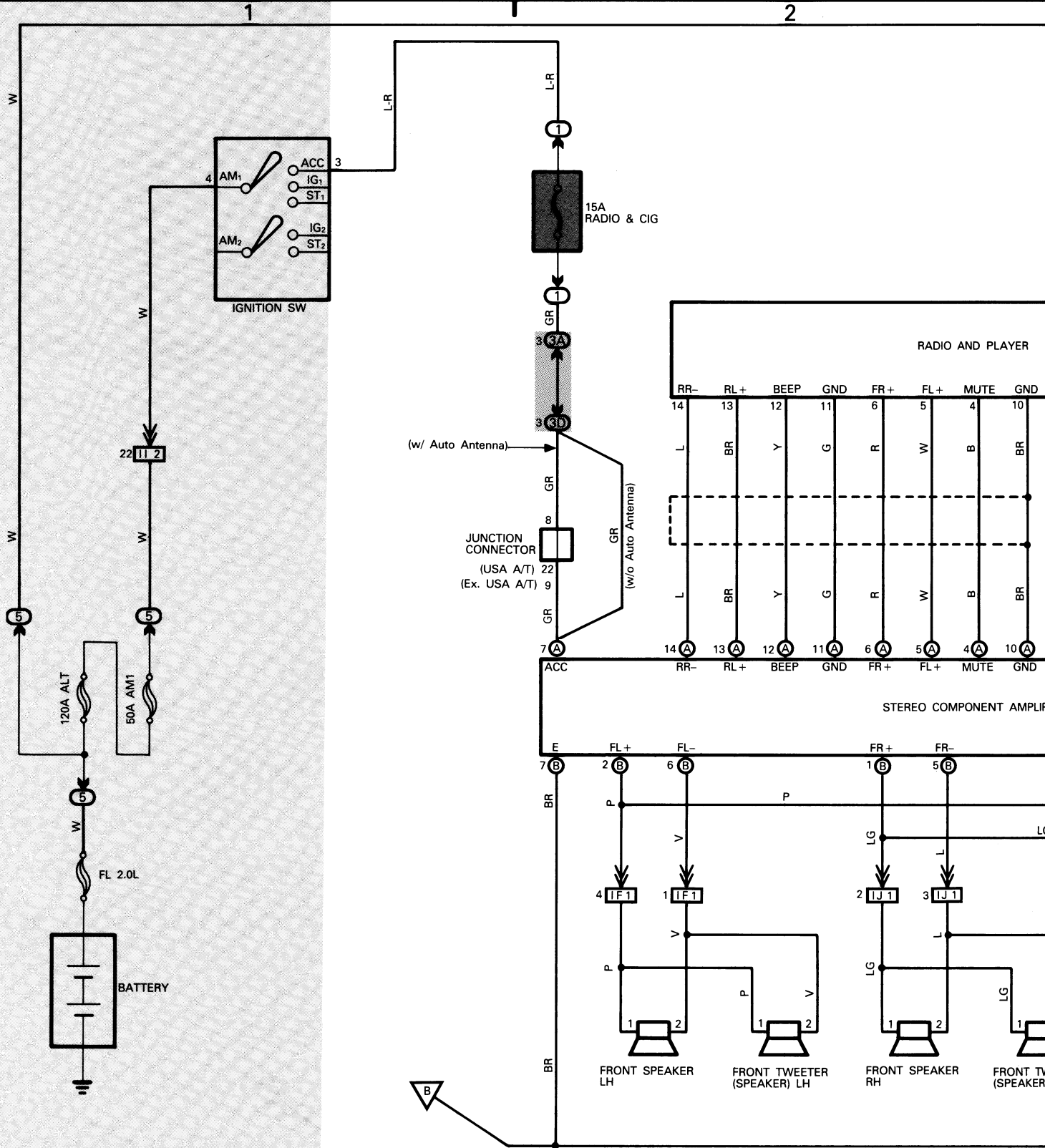

Ground points

= Located on left kick panel

* See last fold-out p. and connector bet



Radio and Player (w/ CD Player)

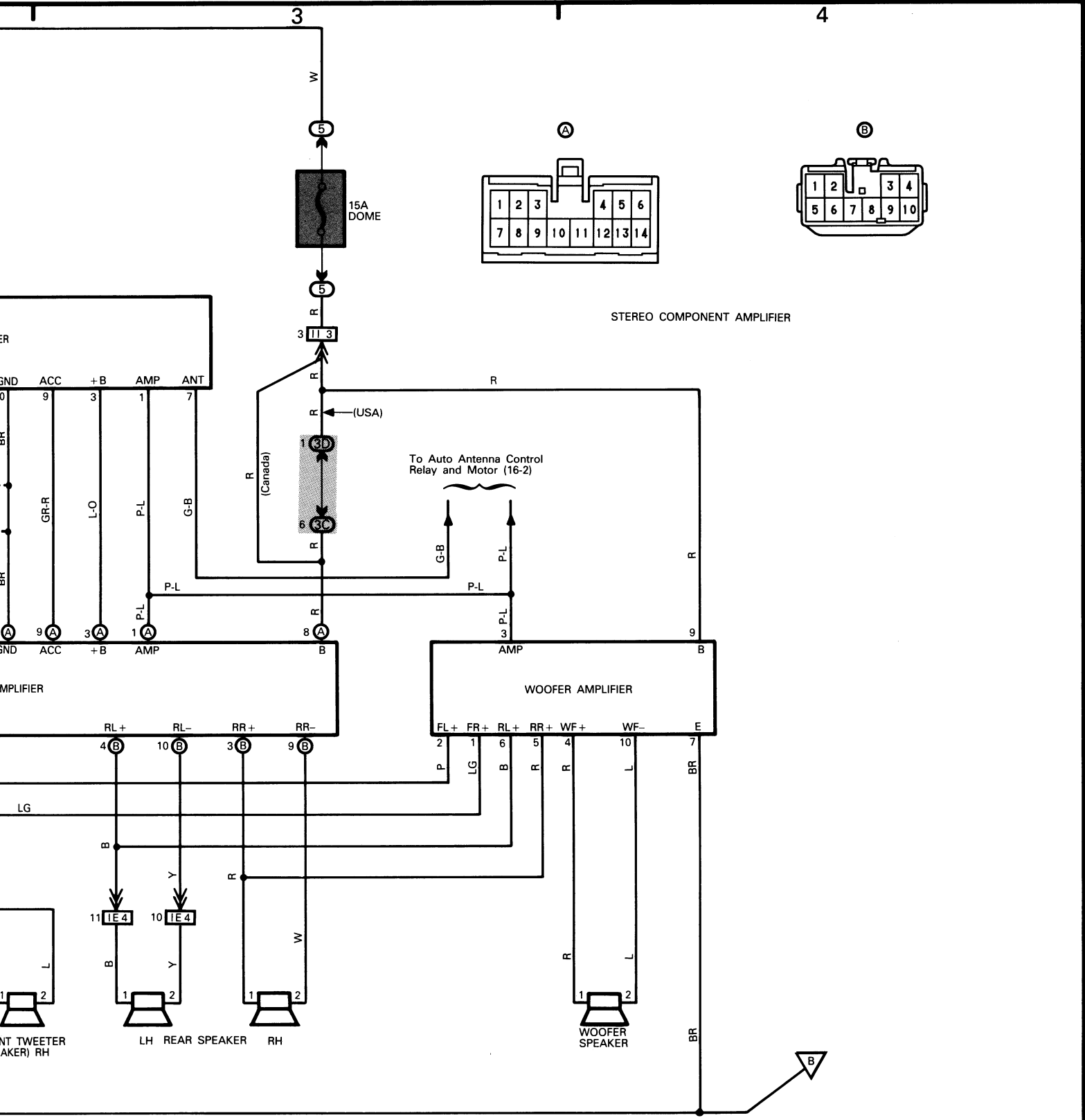

Refer to page for connector to J/B, for connection between wire harness.

18 MR2 (Cont'd)



Power Source

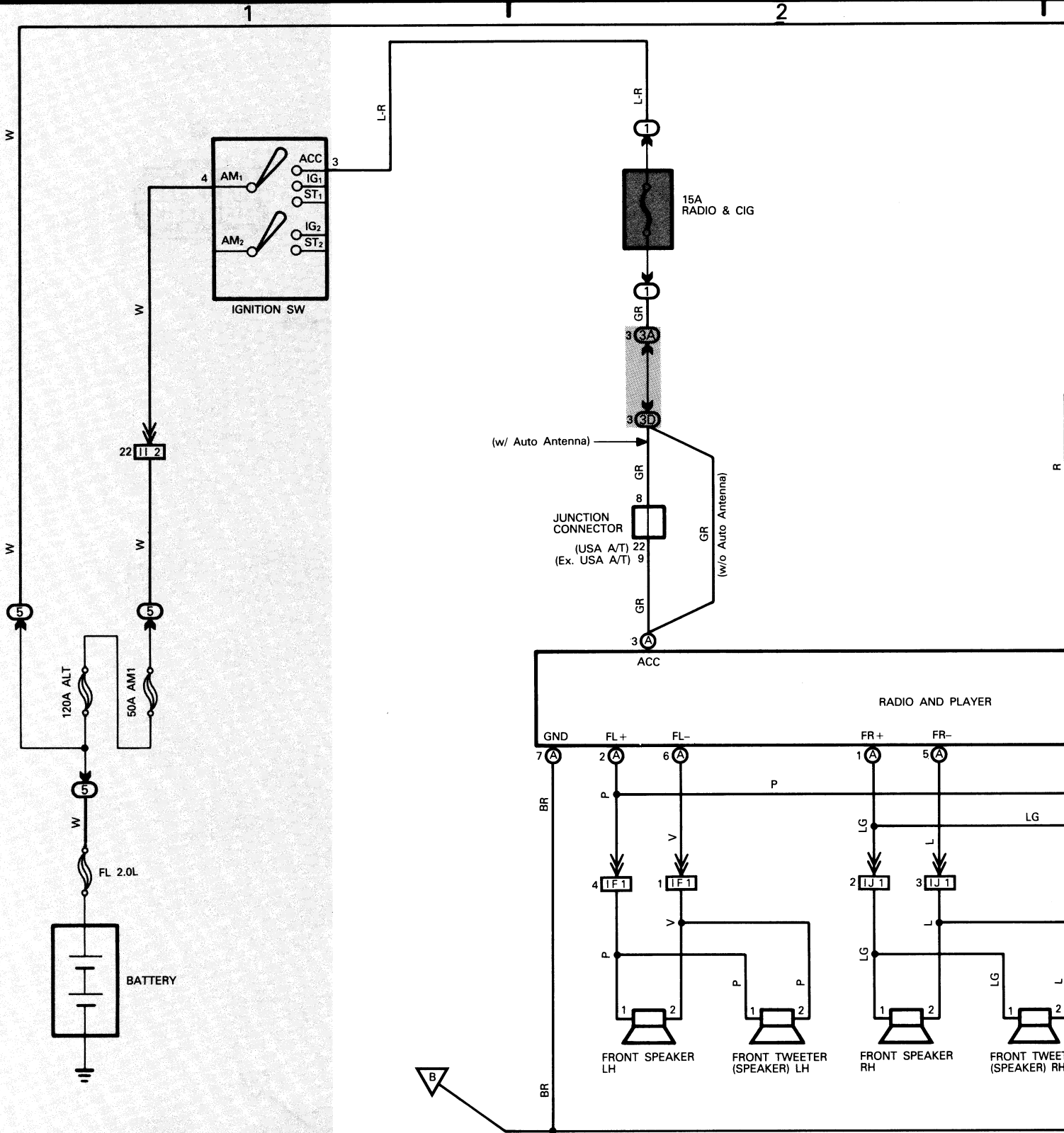

Ground points

= Located on left kick panel

* See last fold-out page for connect and connector between wire harness



Radio and Player (w/o CD Player)

3

4

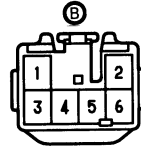
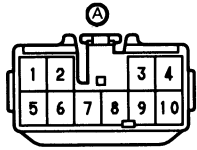

RADIO AND PLAYER

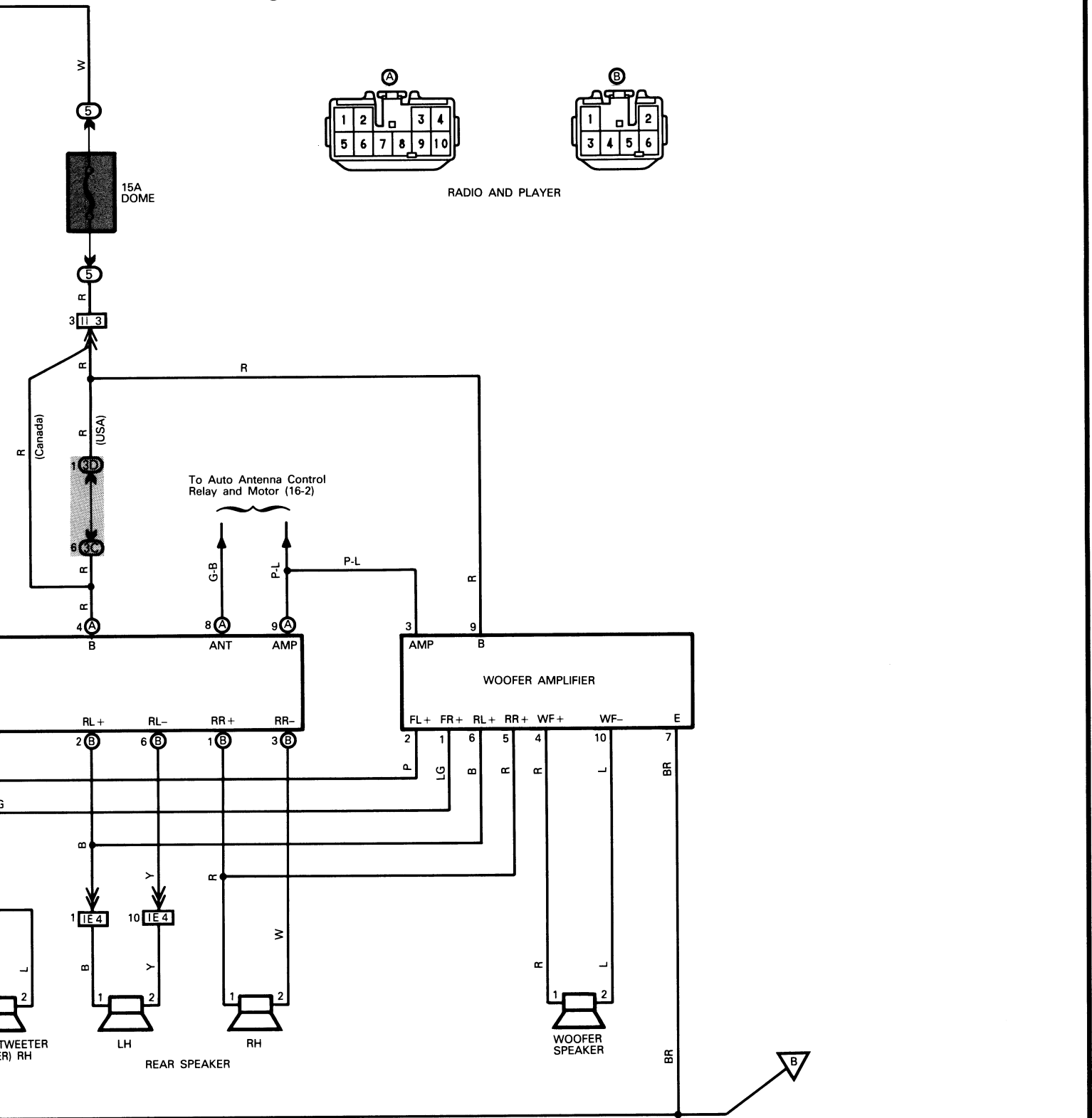

connector to J/B, re harness.

MR2 (Cont'd)



Power Source



Door Lock

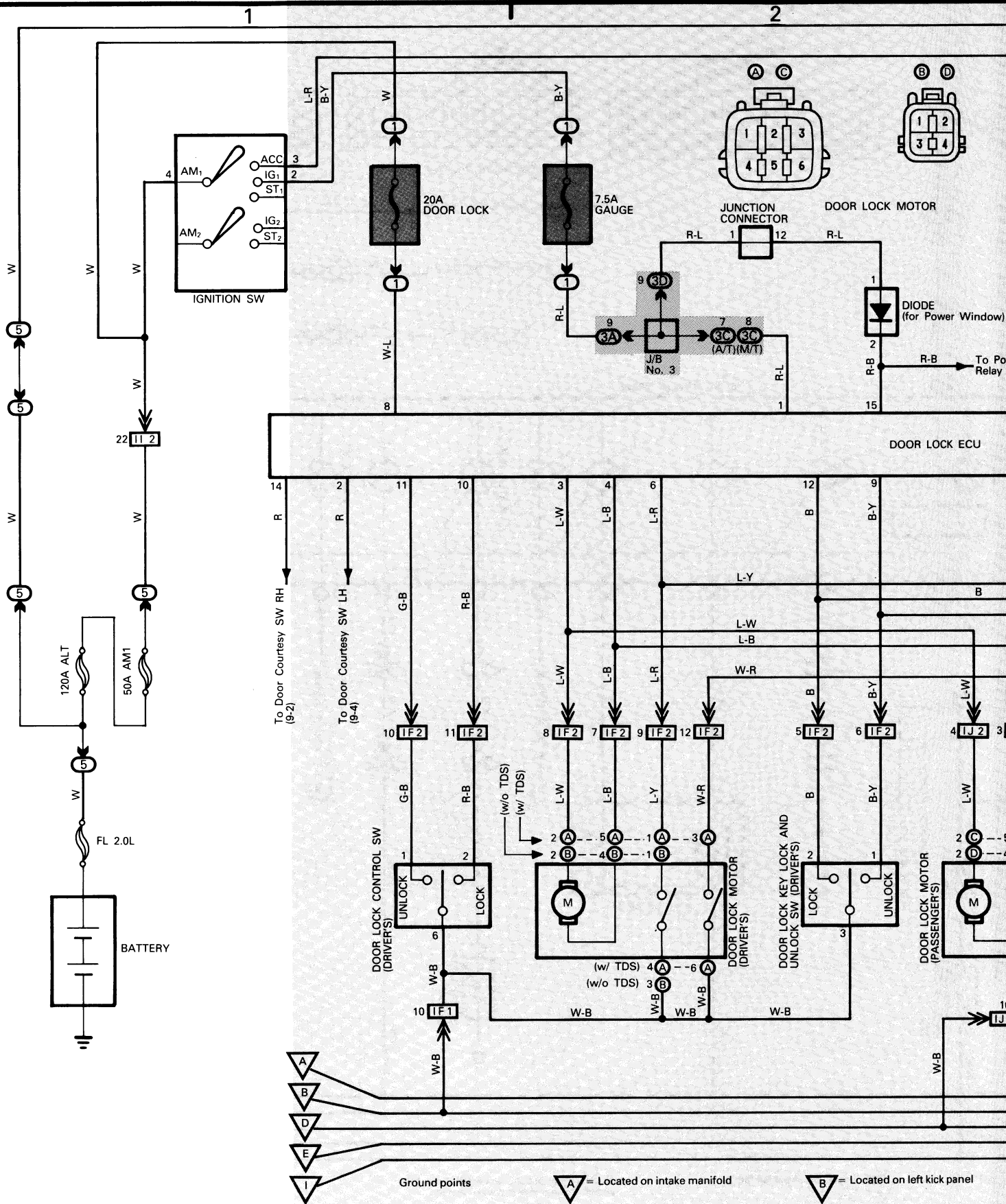



Door Lock

3

4

* TDS = Theft Deterrent System

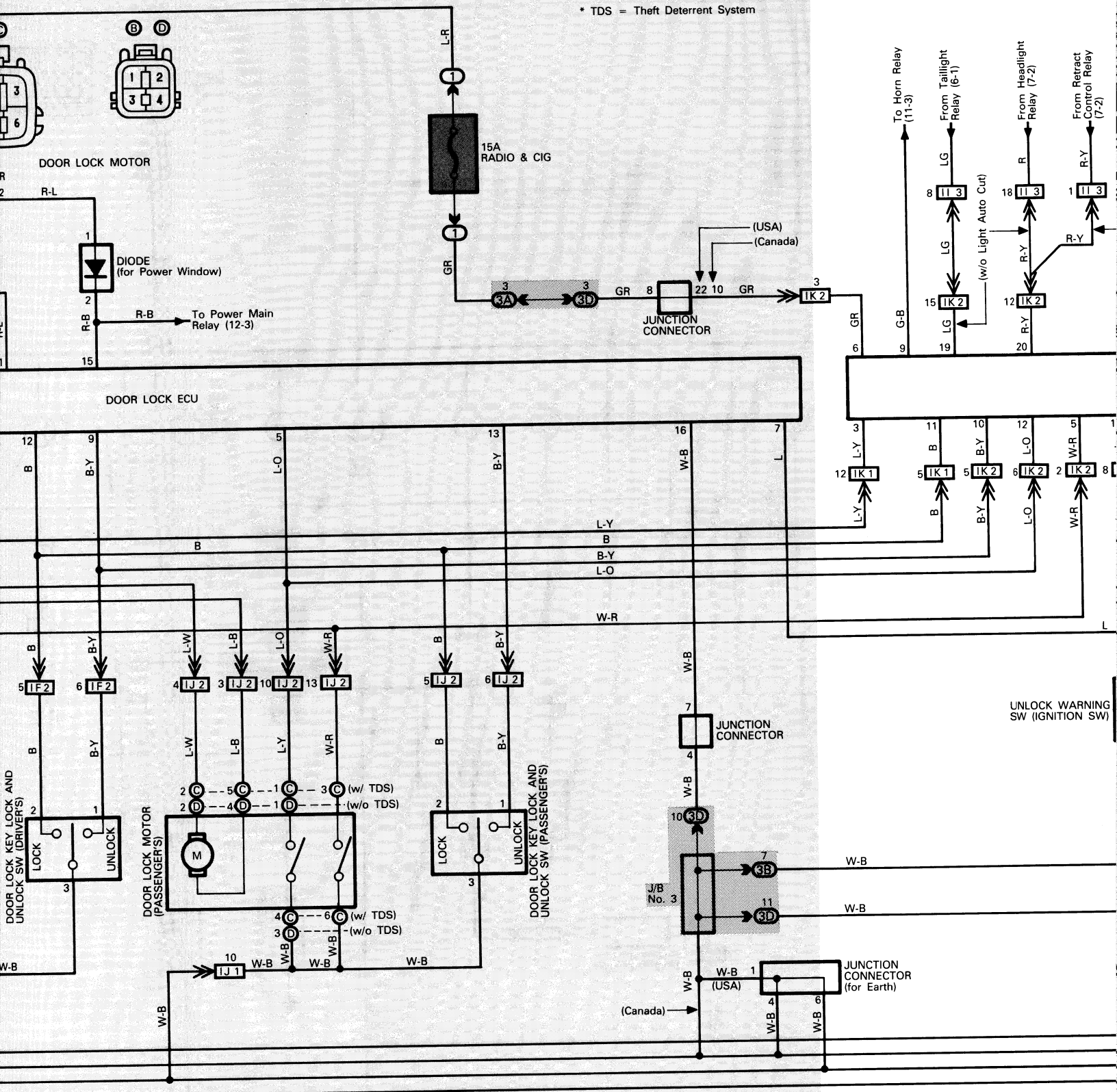

B = Located on left kick panel

D = Located on right kick panel

E = Located on front right fender

I = Located on back panel center

* See and



Theft Deterrent System

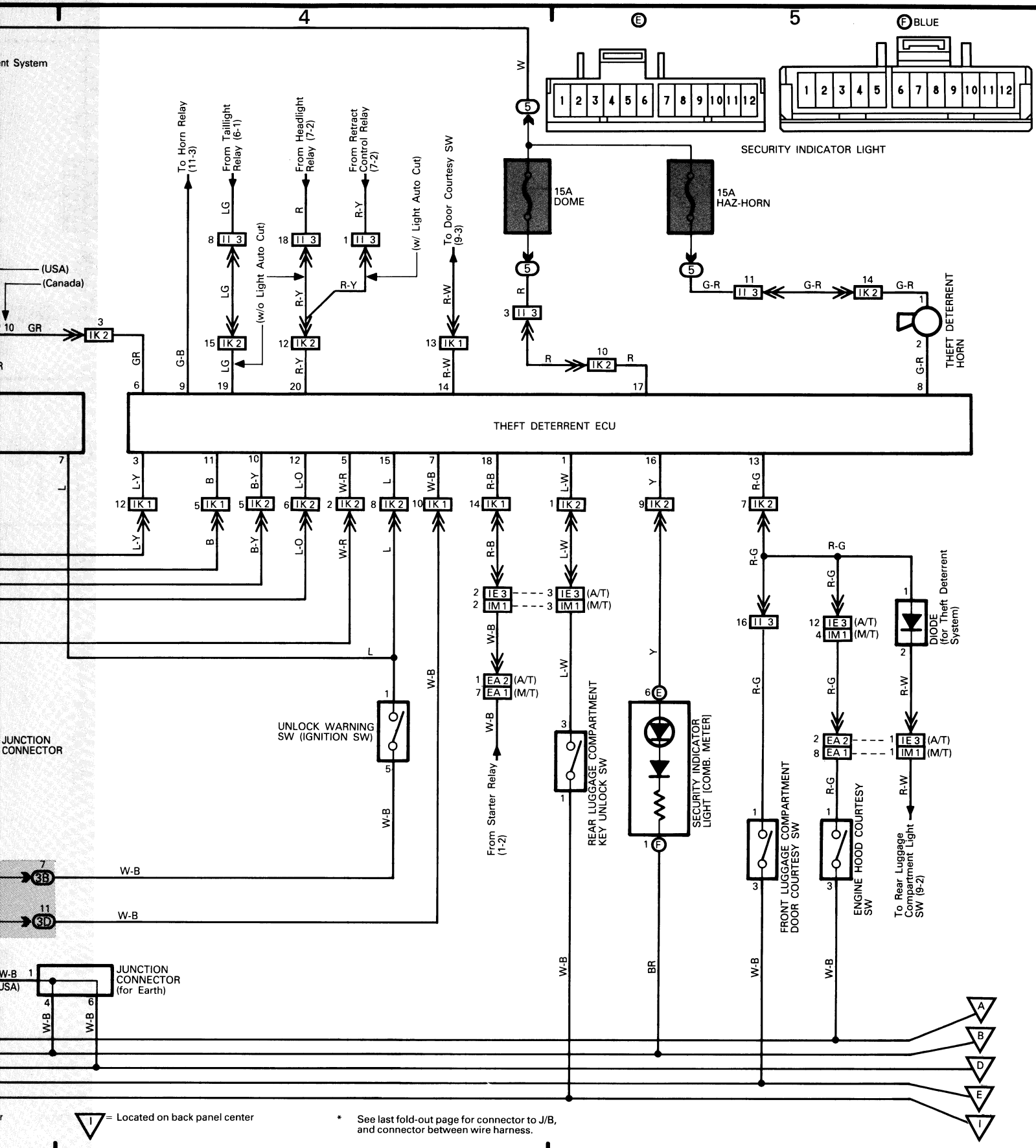

△ = Located on back panel center

* See last fold-out page for connector to J/B, and connector between wire harness.



20 MR2 (Cont'd)

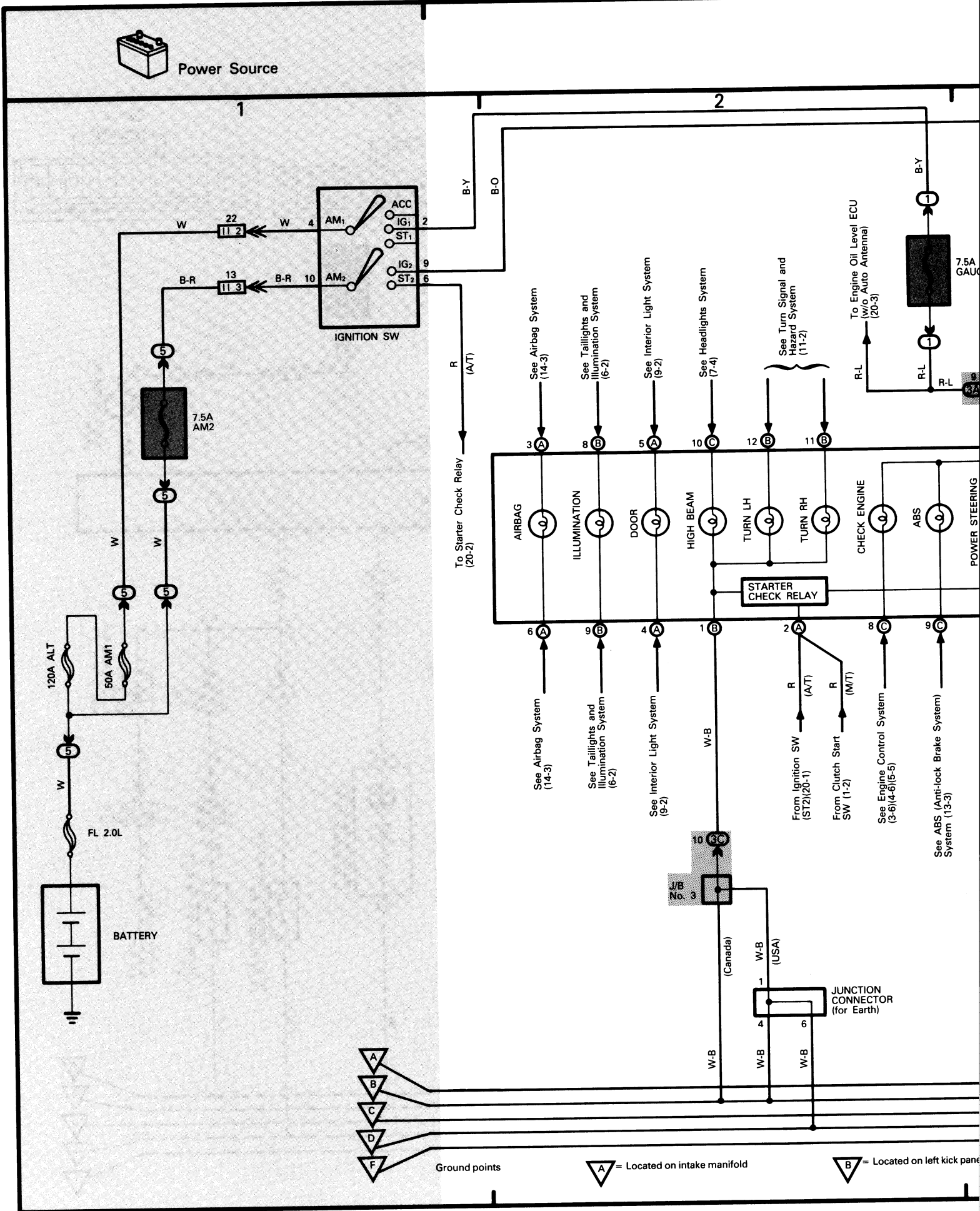

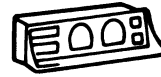

Combination Meter

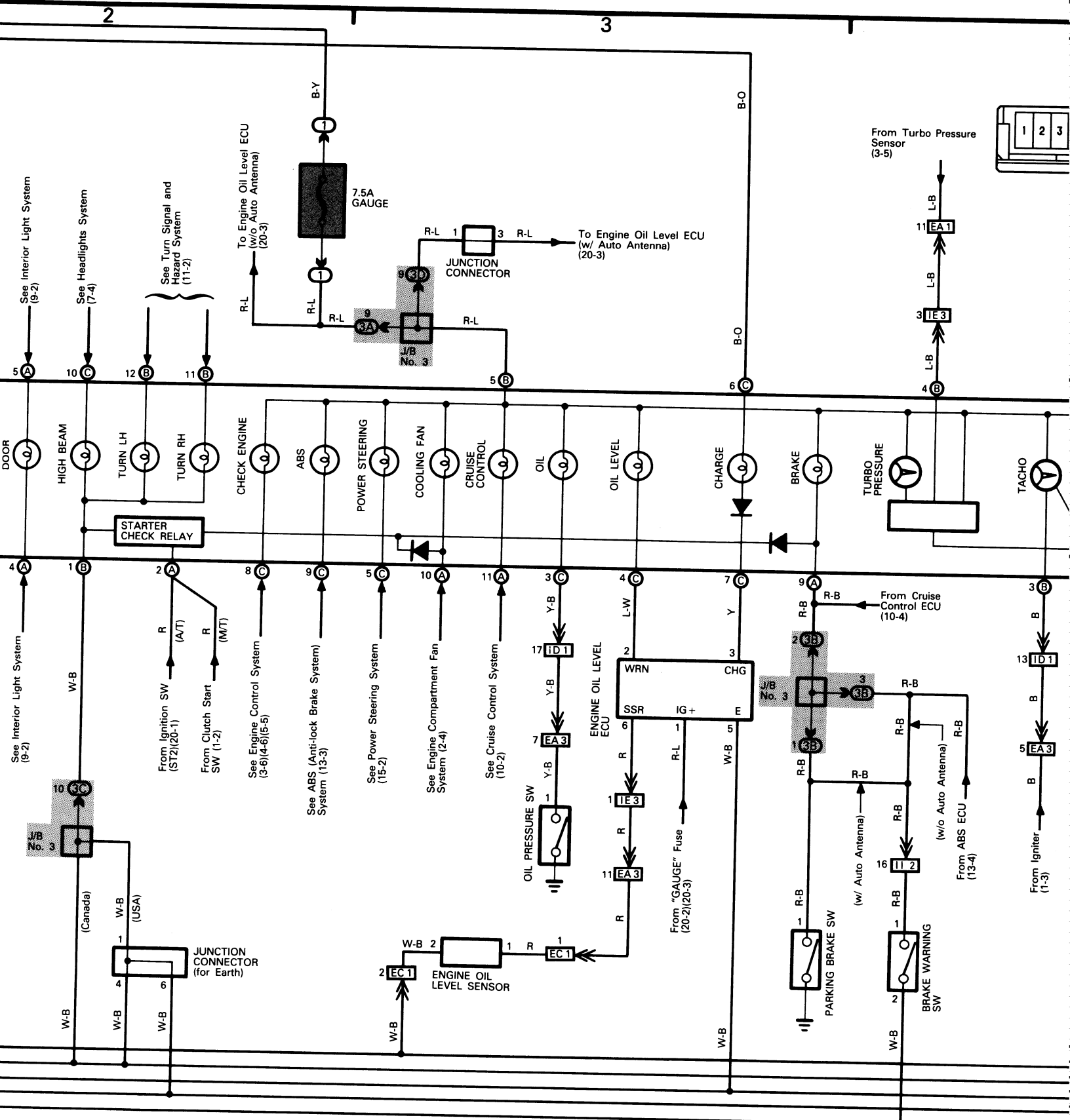

located on intake manifold **B** = Located on left kick panel **C** = Located on instrument panel center **D** = Located on right kick panel **F** = Located on front of engine

ation Meter

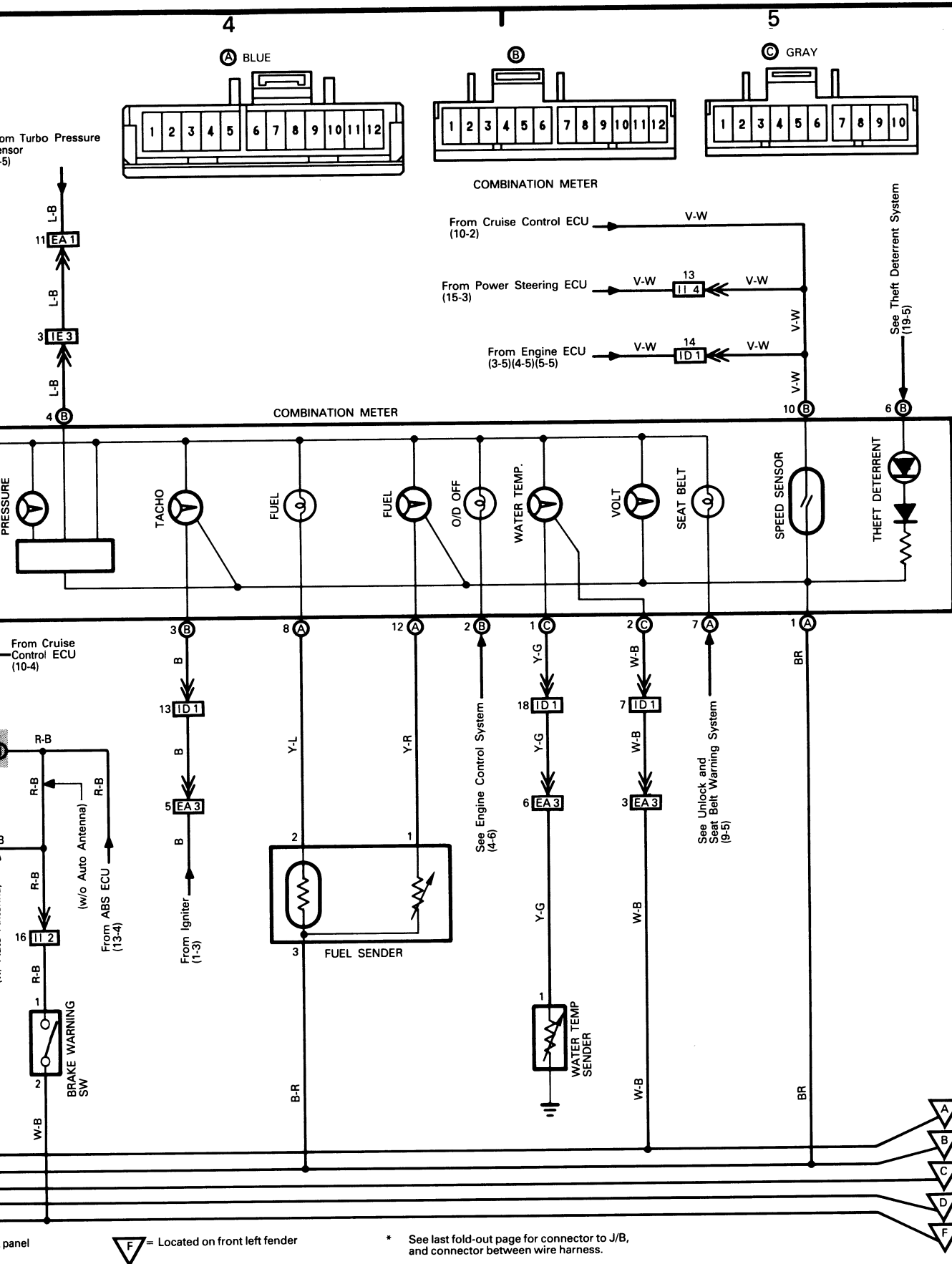

F = Located on front left fender panel

* See last fold-out page for connector to J/B, and connector between wire harness.

MR2 (Cont'd)

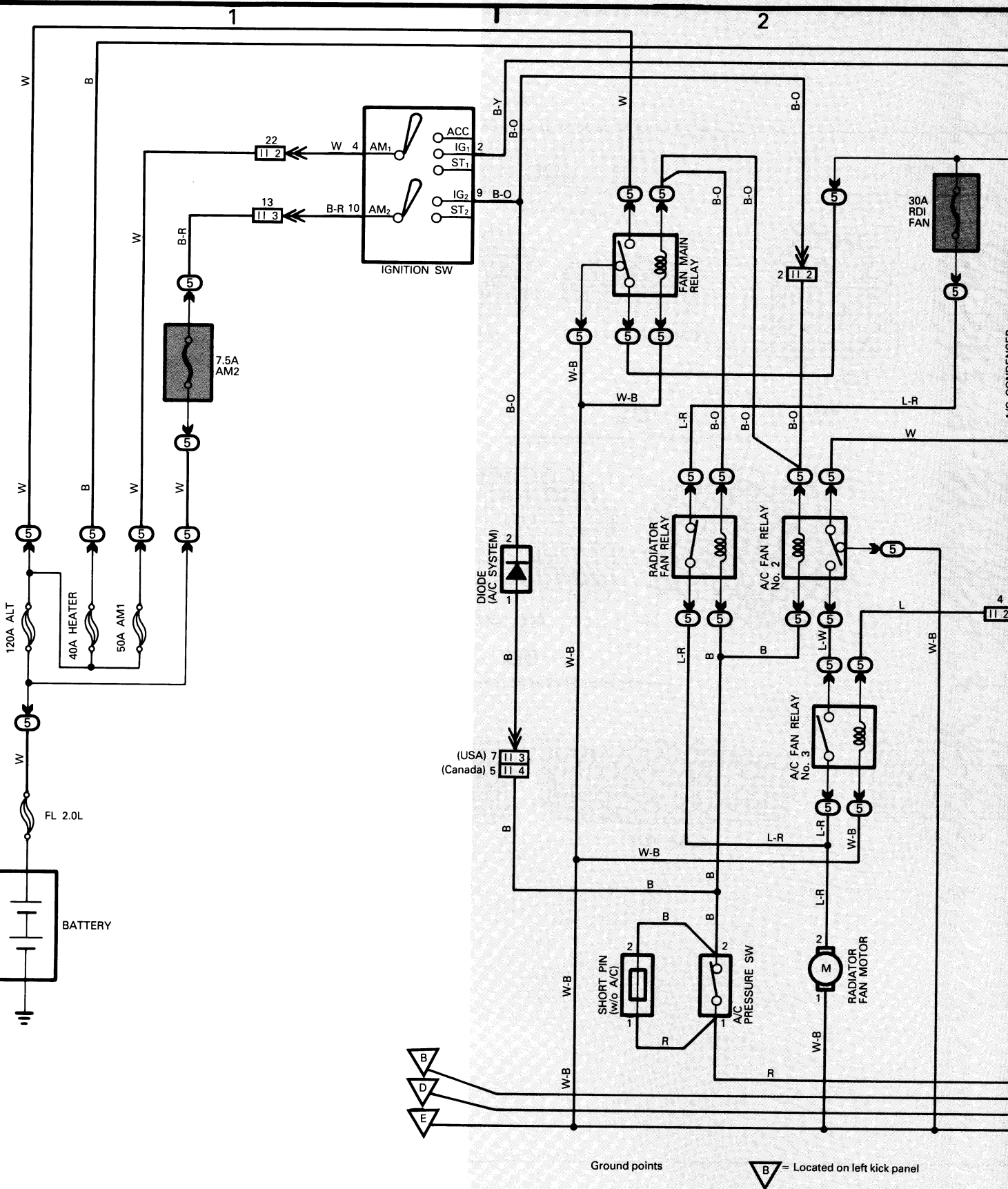
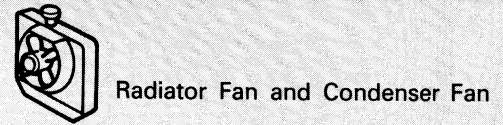

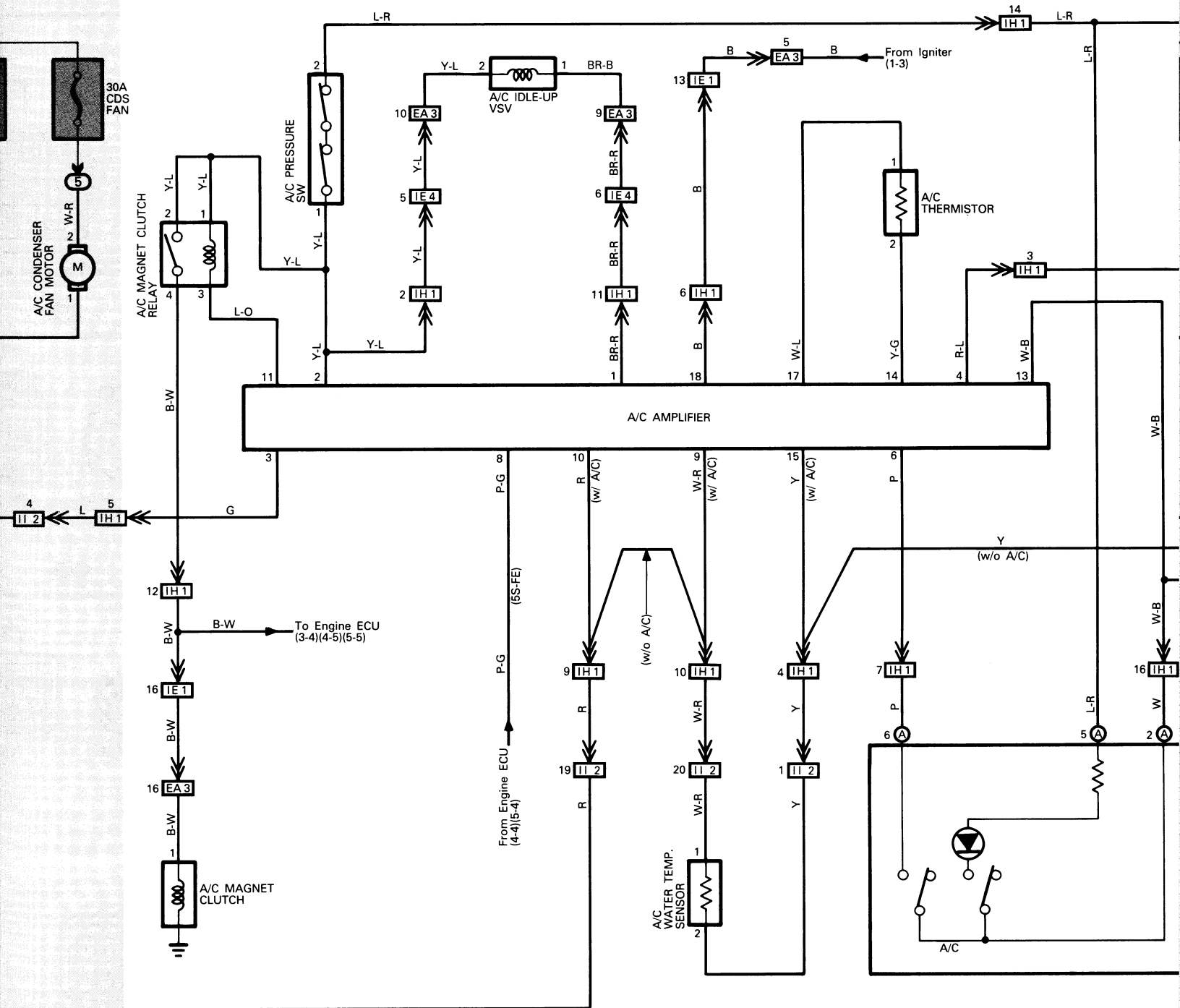

D = Located on right kick panel

E = Located on front right fender

* See last fold-out page for connector to J/B, and connector between wire harness.



Air Conditioner, Cooler and Heater

○ w/ Auto Antenna
△ w/o Auto Antenna

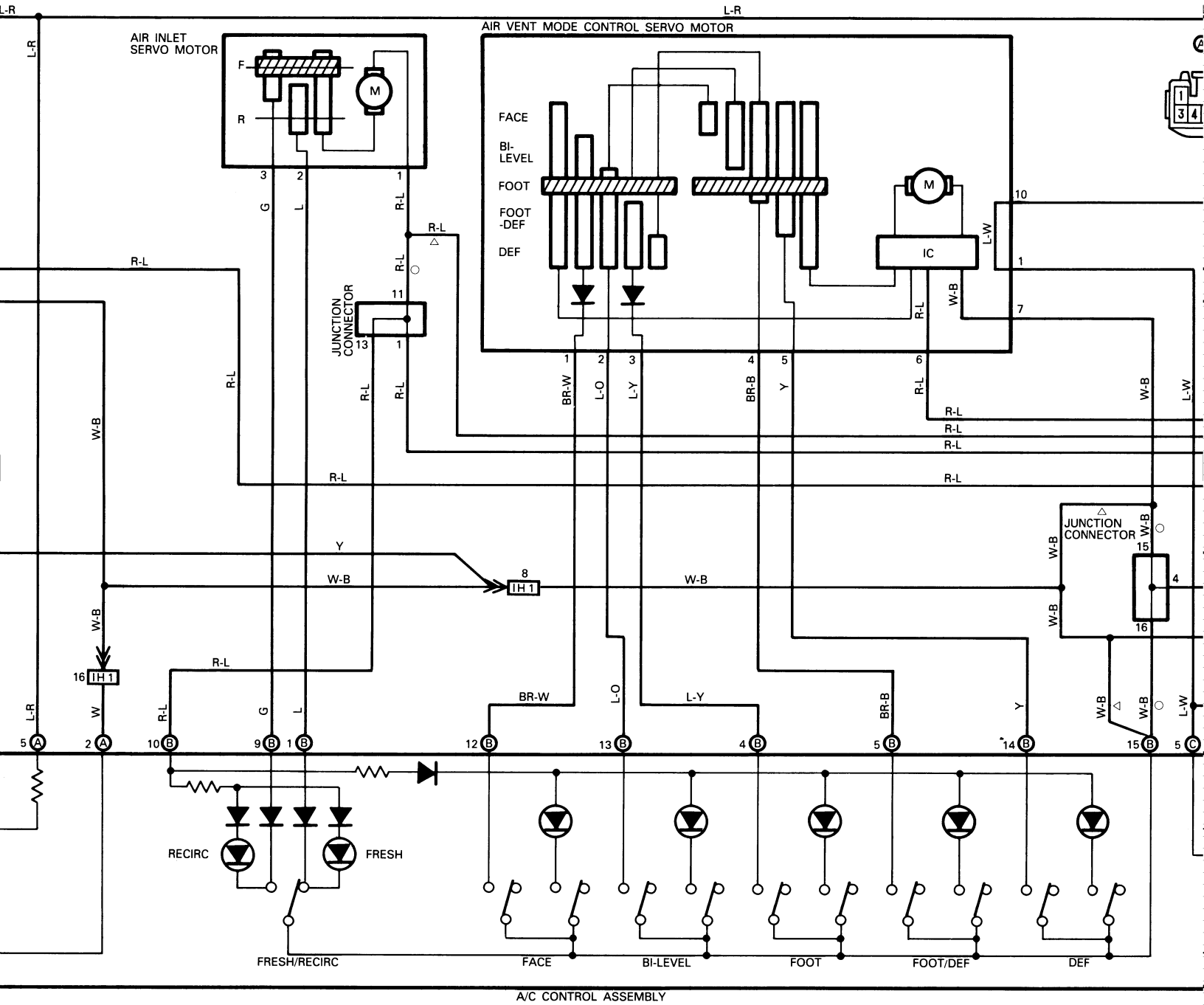

A/C CONTROL ASSEMBLY

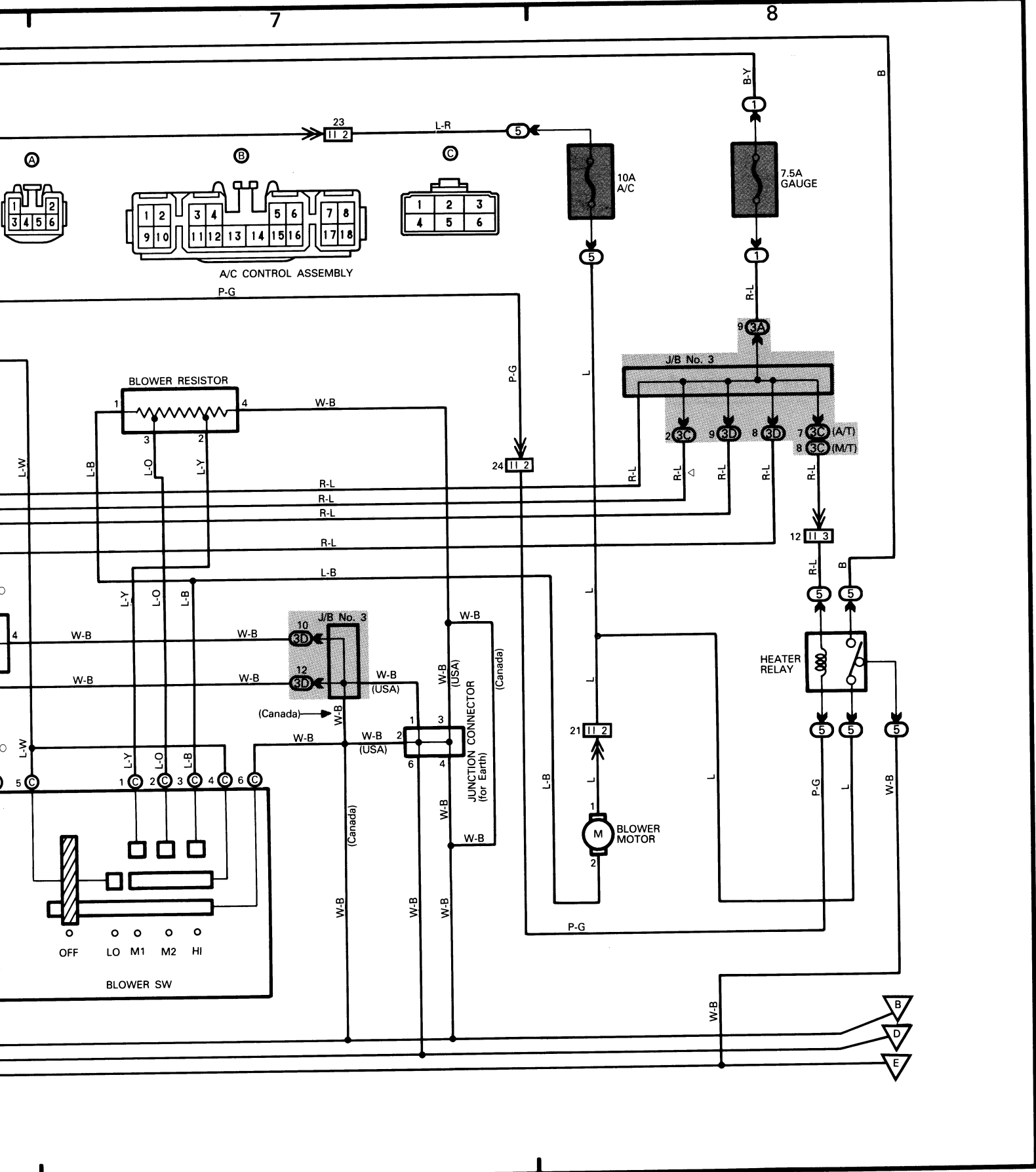

1

2

**Junction Block and Wire Harness Connector
J/B No. 3**

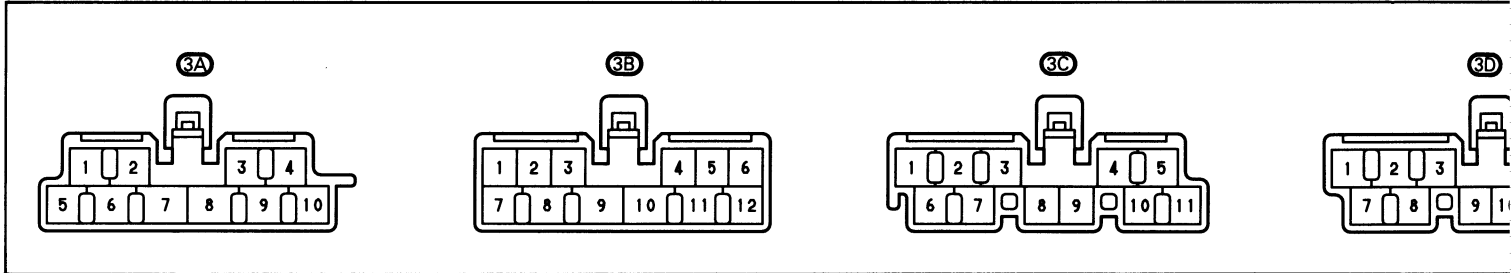

**Connector Joining Wire Harness and Wire Harness
(E Group: Engine Compartment area)**

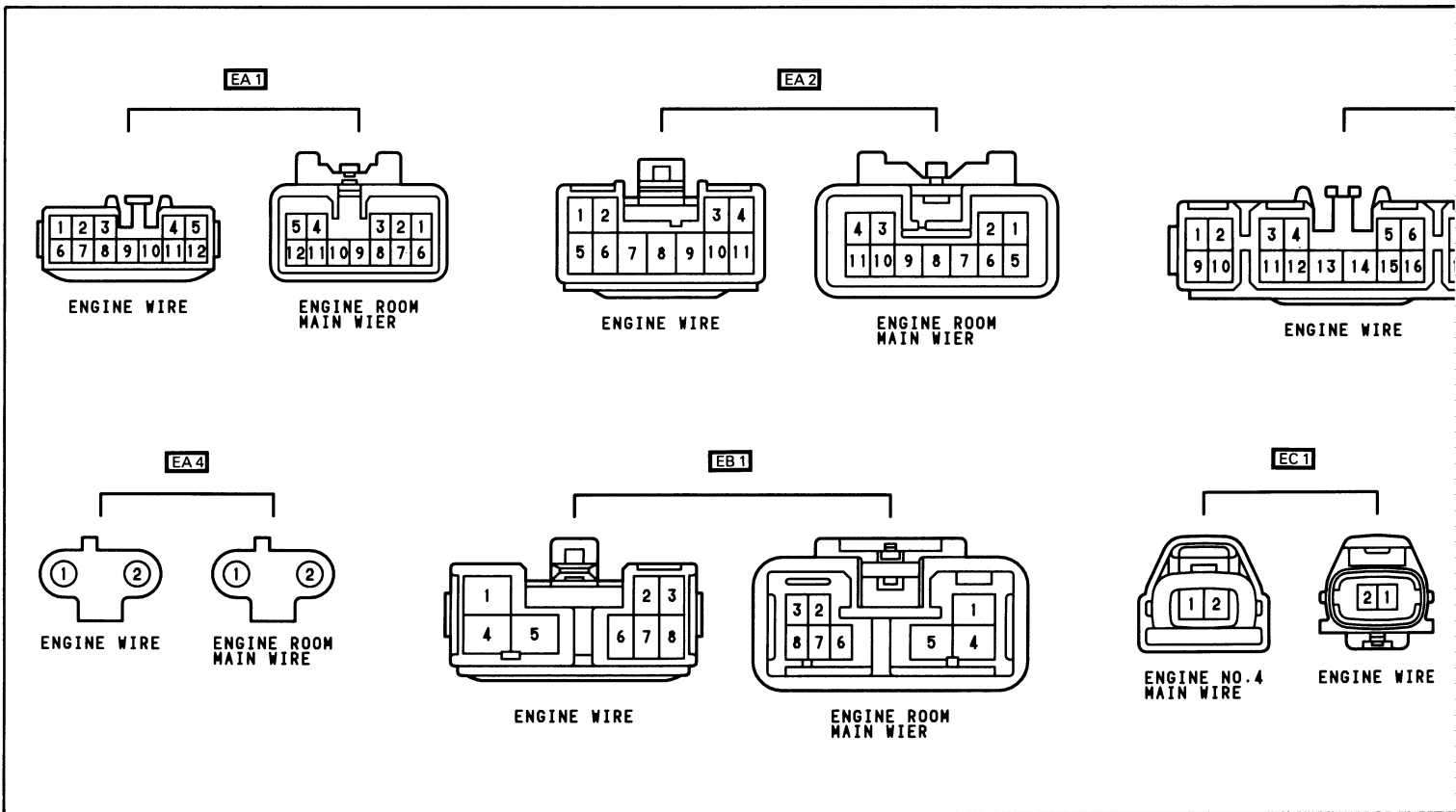

Connector Joining Wire Harness and Wire Harness (I Group: Instrument Panel area)

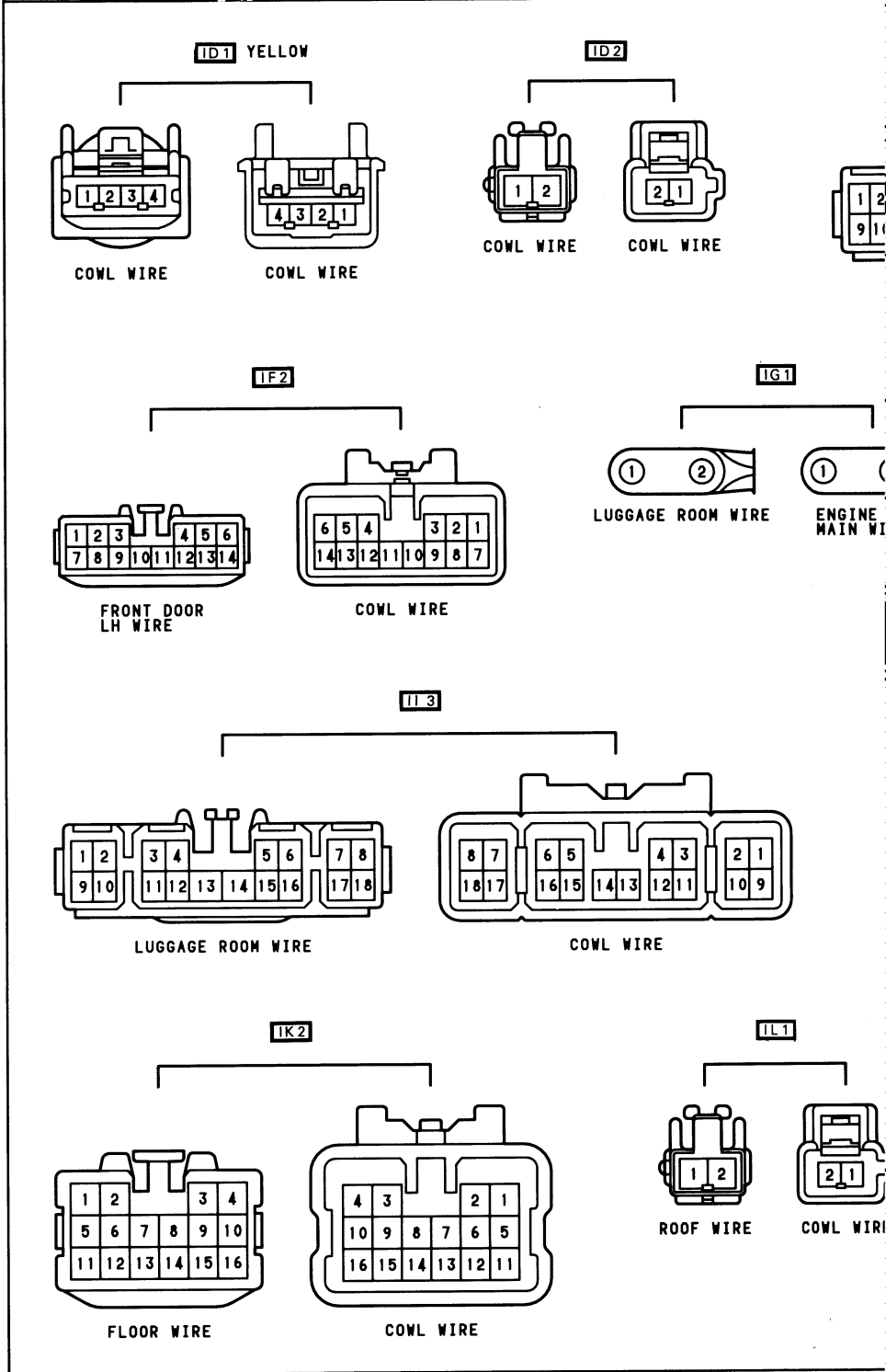
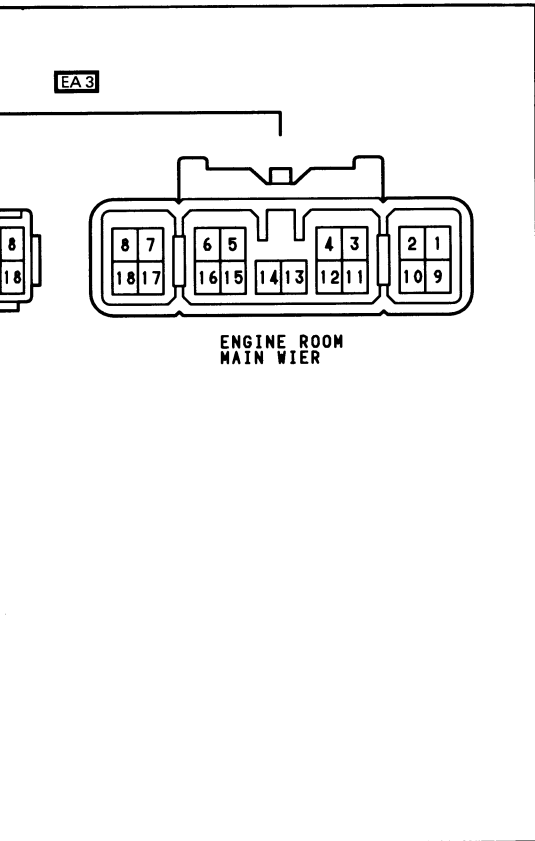
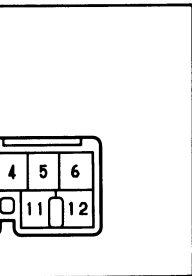

Harness

IE1

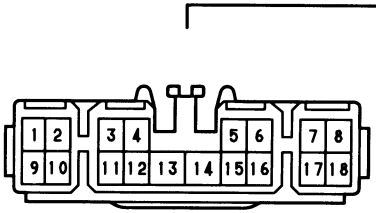

ENGINE ROOM MAIN WIRE

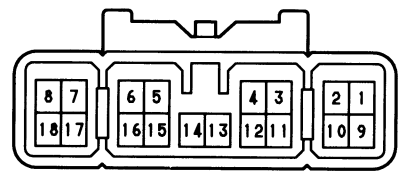

COWL WIRE

IE2

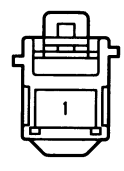

ENGIN ROOM MAIN WIRE

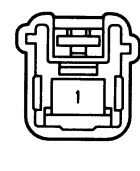

COWL WIRE

IE3

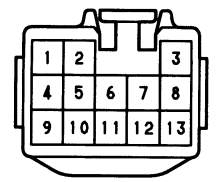

ENGINE ROOM MAIN WIRE

IG1

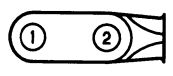

ENGINE ROOM MAIN WIRE

IH1

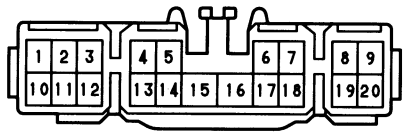

COWL WIRE

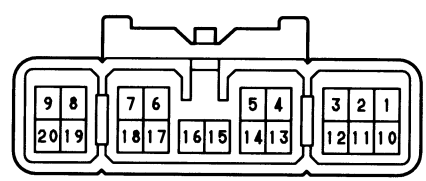

A/C WIRE

II1

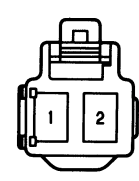

LUGGAGE ROOM WIRE

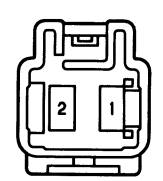

COWL WIRE

II4

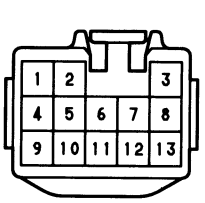

LUGGAGE ROOM WIRE

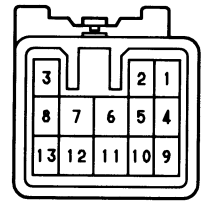

COWL WIRE

IJ1

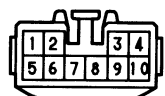

FRONT DOOR RH WIRE

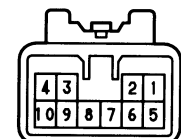

COWL WIRE

IJ2



FRONT DOOR RH WIRE

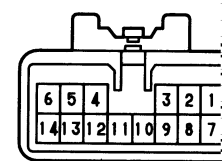

COWL WIRE

LI



COWL WIRE

IM1



ENGINE ROOM MAIN WIRE

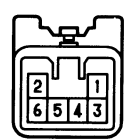

COWL WIRE

IM2

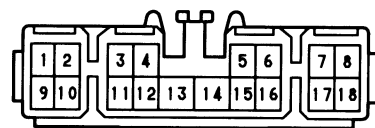

ENGINE ROOM MAIN WIRE

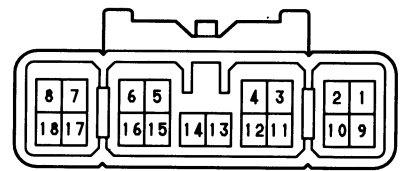

COWL WIRE

7

8

IE3

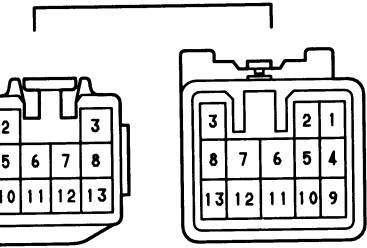

ROOM MAIN WIRE

COWL WIRE

IE4

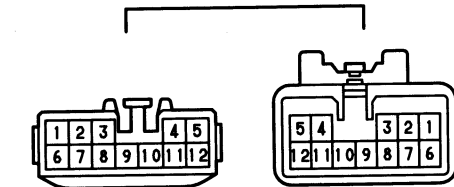

ENGINE ROOM MAIN WIRE

COWL WIRE

IE1

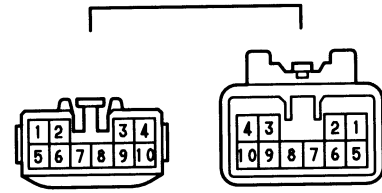

FRONT DOOR
LH WIRE

COWL WIRE

II 2

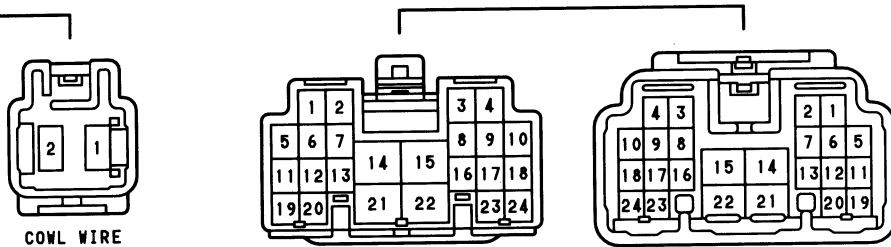

COWL WIRE

LUGGAGE ROOM WIRE

COWL WIRE

IK1

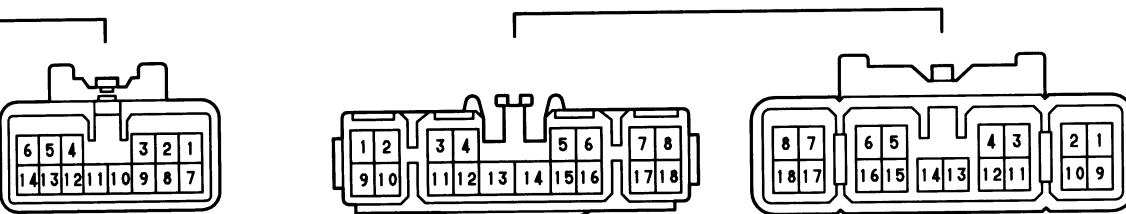

COWL WIRE

FLOOR WIRE

COWL WIRE